Sugar Serve 9.3 Administration Guide

Sugar Serve 9.3 Administration Guide	24
Introduction	24
Overview	24
Core Admin Features	24
Admin Wizard	25
Overview	25
Login Screen	25
Language	26
Your Information	27
Your Locale	28
SugarCloud Insights	30
Overview	30
Team Management	30
Overview	31
Teams Module Tab	31
Team Types	32
The Global Team	32
Standard Teams	32
Private Teams	32
Team Membership Types	33
Creating Teams	34
Creating Via Teams Module	34
Creating Via Duplication	35
Adding Users to Teams Via Teams Module	35
Adding Users to Teams Via Users Module	36
Viewing Teams	38
Viewing Via List View	38
Viewing Via Detail View	38
Viewing Via Recently Viewed	38
Viewing Via Dashlets	39
Viewing Via Reports	39
Searching Teams	40
Teams List View	41
Pagination	41
Checkbox Selection	41
Actions Menu	42
Column Sorting	42
Teams Detail View	43
Actions Menu	43
Users Subpanel	43
Next or Previous Record	44
Editing Teams	45
Editing Via Detail View	45
Editing Via List View	45
Editing Via Users Module	46

Deleting Teams	46
Deleting Via Detail View	47
Deleting Via List View	47
Removing Users From Teams	48
Repairing Teams	49
Role Management	50
Overview	50
Exceptions	50
Roles Module Tab	51
Creating Roles	51
Creating Roles via Role Management	51
Creating Roles via Duplication	52
Setting Module-Level Permissions	53
Module Access Definitions	57
Module Access Type Definitions	57
Record Operation Definitions	58
Setting Record-Level Permissions	58
Enabling Team-Based Permissions	58
Disabling Team-Based Permissions	60
Setting Field-Level Permissions	60
Field Access Definitions	61
Assigning Users to Roles	62
Assigning Roles via Role Management	63
Assigning Roles via User Management	63
Viewing Roles	64
Viewing via List View	64
Viewing via Detail View	65
Viewing via Recently Viewed	65
Viewing Roles by User	65
Viewing via Users Module	66
Searching Roles	67
Roles List View	68
Pagination	68
Checkbox Selection	69
Column Sorting	69
Roles Detail View	69
Actions Menu	70
Role Chart	70
Field Permissions	71
Users Subpanel	71
Editing Roles	72
Editing via Detail View	72
Editing via List View	73
Editing via Users Module	73
Deleting Roles	74

Deleting via Detail View	74
Mass Deleting via List View	74
Password Management	75
Overview	75
Password Requirements	75
Advanced Options	76
System-Generated Passwords	77
User Reset Password	78
CAPTCHA Validation	78
Honeypot Validations	79
Email Templates	80
User-Generated Password Expiration	80
Login Lockout	81
External Authentication	82
LDAP	82
LDAP Fields	83
SAML	85
SAML Fields	87
Setting User Passwords	89
User Management	89
Overview	89
Licensed User Limits	90
User Types	90
Regular User	90
System Administrator	91
Group User	91
Portal API User	91
License Types	92
Enhanced Module Functionality for Sugar Sell License Types	95
Enhanced Module Functionality for Sugar Serve License Types	96
User Fields	96
Understanding the Reports To Field	103
Users Module Tab	103
Creating Users	104
Creating Via Module Tab	105
Regular and Admin Users	105
Group Users	107
Portal API Users	108
Creating Via Duplication	109
Creating Via Import	110
Viewing Users	111
Viewing via Recently Viewed	111
Viewing via List View	112
Viewing via Detail View	112
Viewing via Dashlets	112

Viewing via Reports	113
Searching Users	113
Basic Search	114
Advanced Search	114
Users List View	115
Checkbox Selection	115
Actions Menu	116
Pagination	117
Column Sorting	117
Users Detail View	117
Actions Menu	118
Tabs	119
User Profile	119
Advanced	120
Access	120
Subpanels	121
Editing Users	121
Editing via Detail View	122
External Accounts	122
Editing via List View	124
Deactivating Users	124
Deleting Users	125
Exporting Users	125
Mass Updating Users	126
Resetting User Preferences	127
Resetting User Passwords	128
Reassigning Records	129
Sugar Connect	132
Overview	132
License Management	133
Download Key	133
Editing the License Key	134
License Validation	135
License Expiration	135
Re-validating the License	135
Manual Validation	136
Sugar Updates	137
Online Documentation	138
System	140
Overview	140
System Settings	141
User Interface	142
Proxy Settings	143
Customer Self-Service Portal	144
SkypeOut	144

Preview Pane Settings	144
Activity Streams	145
SugarBPM™	145
Comment Log Settings	146
Advanced	146
Logger Settings	147
View Log	148
Locale	149
User Interface	150
System Currency	150
Export Settings	151
Database Collation	151
Currencies	152
Updating Conversion Rates	153
Languages	154
Search	154
Configuring Full-Text Search	155
Activating Full-Text Search	156
Indexing Full-Text Search	157
Configuring Legacy Global Search	158
Connectors	158
Setting Connector Properties	159
Enabling Connectors	160
Mapping Connector Fields	160
Managing Connector Search	161
OAuth Keys	161
OAuth Keys Fields	161
OAuth Keys Module Tab	162
Creating OAuth Keys	163
Creating Via OAuth Keys Module	163
Creating Via Duplication	163
Viewing OAuth Keys	164
Viewing Via List View	164
Viewing Via Detail View	164
Viewing Via Recently Viewed	165
Searching OAuth Keys	165
Basic Search	165
Advanced Search	166
OAuth Keys List View	167
Pagination	167
Checkbox Selection	167
Actions Menu	168
Column Sorting	169
OAuth Keys Detail View	169
Actions Menu	169

Next or Previous Record	170
Tokens	170
Editing OAuth Keys	170
Editing Via Detail View	171
Editing Via List View	171
Deleting OAuth Keys	171
Deleting Via Detail View	172
Mass Deleting Via List View	172
Exporting OAuth Keys	173
Mass Updating OAuth Keys	173
Import Wizard	174
Backups	174
Repair	174
Diagnostic Tool	175
Tracker	177
Scheduler	179
PDF Manager	179
Mobile	179
Configuring Sugar Mobile	180
Configuring Mobile Browser Access	180
Enabling Modules for Mobile Access	180
Enabling Offline Mobile Access	181
Repair	182
Overview	182
Quick Repair and Rebuild	182
Upgrade Teams	184
Expand Column Width	184
Rebuild .htaccess File	185
Rebuild Config File	185
Rebuild Sugar Logic Functions	186
Rebuild Relationships	186
Rebuild Schedulers	186
Rebuild Sugar Dashlets	187
Rebuild WorkFlow	188
Rebuild Javascript Languages	188
Rebuild Sidecar Files	188
Rebuild JS Grouping Files	188
Rebuild Sprites	188
Repair Non-Lowercase Fields	189
Repair Teams	189
Repair Roles	190
Repair Inbound Email Accounts	190
Remove XSS	190
Repair Activities	191
Enable/Disable Seed Users	191

Clear Additional Cache	191
Schedulers	192
Overview	192
Schedulers Fields	192
Default Schedulers	193
SugarBPM Scheduled Job	194
Activity Stream Purger	194
Check Inbound Mailboxes	195
Clean Jobs Queue	195
Create Future TimePeriods	195
Elasticsearch Queue Scheduler	196
Process Workflow Tasks	196
Prune Database on 1st of Month	196
Prune Old Record Lists	196
Prune Tracker Tables	197
Publish Approved Articles & Expire KB Articles	197
Rebuild Denormalized Team Security Data	197
Remove Diagnostic Tool Files	198
Remove Temporary Files	198
Remove Temporary PDF Files	198
Run Email Reminder Notifications	198
Run Nightly Mass Email Campaigns	199
Run Nightly Process Bounced Campaign Emails	199
Run Report Generation Scheduled Tasks	199
Sugar Heartbeat	200
Update tracker_sessions Table	200
Schedulers Module Tab	200
Creating Schedulers	201
Creating via Schedulers Module	201
Creating via Duplication	202
Viewing Schedulers	203
Viewing via List View	203
Viewing via Detail View	203
Viewing via Recently Viewed	203
Searching Schedulers	204
Schedulers List View	204
Pagination	205
Checkbox Selection	205
Actions Menu	206
Favorite Designation	206
Column Sorting	206
Schedulers Detail View	207
Actions Menu	207
Favorite Designation	207
Next or Previous Record	208

Job Log	208
Editing Schedulers	209
Editing via Detail View	210
Editing via List View	210
Deleting Schedulers	211
Deleting via Detail View	211
Mass Deleting via List View	211
Exporting Schedulers	212
Mass Updating Schedulers	212
Favoriting Schedulers	213
Favoriting via List View	213
Favoriting via Detail View	214
Advanced Options	214
Setting up Cron Scheduler	216
Setting Up in Unix/Linux	216
PDF Manager	217
Overview	217
PDF Manager Fields	217
PDF Manager Module Tab	218
Creating PDF Templates	219
Creating Via PDF Manager Module	219
Creating Via Duplication	220
Creating Content	220
Viewing PDF Templates	222
Viewing Via List View	222
Viewing Via Detail View	222
Viewing Via Recently Viewed	222
Searching PDF Templates	223
PDF Manager List View	223
Pagination	223
Checkbox Selection	224
Actions Menu	224
Column Sorting	225
PDF Manager Detail View	225
Actions Menu	225
Next or Previous Record	226
Editing PDF Templates	226
Editing Via Detail View	227
Editing Report PDF Template	227
Deleting PDF Templates	228
Deleting Via Detail View	228
Mass Deleting Via List View	229
Adding a Header Image to PDF Template	229
Previewing PDF Templates	230
Web Logic Hooks	231

Overview	231
Web Logic Hook Fields	231
Working With Sugar Modules	232
Web Logic Hooks Menus	232
Module Tab Menus	233
List View Menus	233
List View Mass Actions Menu	234
List View Record Actions Menu	234
Record View Actions Menu	235
Email	236
Overview	236
Email Accounts	236
Incoming Email Accounts	237
System Email Settings	237
Outgoing Mail Configuration	237
Email Options	239
Email Security Settings	240
Related Contacts Emails	240
Campaign Email Settings	241
Email Archiving	242
Enabling Email Archiving	242
Inbound Email	243
Inbound Email Fields	244
Inbound Email Module Tab	247
Creating Inbound Email Accounts	247
Creating Group Mail Accounts	248
Creating Bounce Handling Accounts	248
Creating via Duplication	249
Viewing Inbound Email Accounts	250
Viewing via List View	250
Viewing via Detail View	250
Viewing via Recently Viewed	251
Inbound Email List View	251
Modifying the Case Macro	251
Pagination	252
Checkbox Selection	252
Action Buttons	253
Column Sorting	253
Inbound Email Detail View	254
Action Buttons	254
Editing Inbound Email Accounts	254
Editing via Detail View	254
Editing via List View	255
Deleting Inbound Email Accounts	255
Deleting via Detail View	255

Mass Deleting via List View	256
Creating Cases From Email	256
Email Queue	257
Viewing via List View	257
Searching Queued Email	258
Basic Search	258
Advanced Search	258
Email Queue List View	259
Pagination	260
Checkbox Selection	260
Actions Menu	261
Column Sorting	261
Deleting Queued Email	261
Mass Deleting via List View	262
Mass Updating Queued Email	262
Sending Queued Email	263
Developer Tools	264
Overview	264
Studio	265
Module Builder	265
Module Loader	266
Sugar Portal	266
Workflow Management	266
Rename Modules	267
Display Modules and Subpanels	268
Configure Navigation Bar Quick Create	269
Configure API Platforms	270
Dropdown Editor	272
Adding Dropdown Lists	272
Viewing Dropdown Lists	274
Editing Dropdown Lists	275
Editing Sales Stages	277
Editing Time Intervals	279
Editing Role-Based Availability	280
Studio	281
Overview	281
Navigation	282
Main Panel	282
Modules Panel	283
Footer	284
Editing Labels	284
Fields	286
Field Types	286
Field Options	289
Creating Fields	296

Editing Fields	297
Deleting Fields	298
Cloning Fields	300
Relationships	302
Relationship Types	302
One-to-One Relationships	303
One-to-Many and Many-to-One Relationships	304
Many-to-Many Relationships	305
Creating Relationships	306
Editing Relationships	307
Deleting Relationships	308
Layouts	310
Layout Types	311
Layout Options	313
Panels	313
Tabs	314
Restoring Layouts	314
Sync And Copy (Legacy Modules)	315
Editing Layouts	316
Editing Record View Layout	316
Creating Role-Based Record View Layouts	318
Copying a Role-View From a Customized Role-View Layout	320
Restoring Customized Role-Views to the Default Role-View Layout	320
Restoring the Default Role-View to the System Default Layout	321
Editing List View Layout	321
List View Column Widths	323
Editing Search Layout	324
Editing Record View Dashlet Layout	324
Editing Convert Lead Layout	325
Subpanels	326
Subpanel Options	327
Editing Subpanels	328
Mobile Layouts	330
Mobile Layout Types	330
Mobile Layout Options	331
Editing Mobile Layouts	331
Using Sugar Logic	335
Functions	336
List of Functions	338
Fields	344
Related Field	345
Rollup	346
Viewing Layout History	346
Restoring Default Layouts	348
Resetting Modules	349

Exporting Customizations	349
Exporting Role-Based Customizations	351
Module Builder	351
Overview	351
Navigation	351
Main Panel	352
Packages Panel	352
Footer	353
Packages	353
Creating Packages	354
Deploying Packages	355
Deleting Packages	356
Modules	357
Module Types	357
Module Options	358
Creating Modules	359
Creating Modules Via Package	359
Creating Modules Via Duplication	360
Modifying Modules	361
Modifying Labels	362
Fields	363
Field Types	363
Field Options	365
Creating Fields	373
Editing Fields	374
Deleting Fields	376
Cloning Fields	378
Relationships	379
Relationship Types	380
Creating Relationships	383
Editing Relationships	384
Deleting Relationships	385
Layouts	386
Layout Types	387
Layout Options	388
Editing Layouts	389
Editing Record View Layout	389
Editing List View Layout	391
Mobile Layouts	394
Mobile Layout Types	394
Mobile Layout Options	395
Editing Mobile Layouts	395
Available Subpanels	398
Subpanel Options	399
Editing Subpanel Layout	399
Using Sugar Logic	402

Viewing Layout History	402
Restoring Layout Defaults	403
Deleting Modules	404
Module Loader	405
Overview	405
Module Loader Layout	405
Module Loader Fields	406
Uploading Packages	407
Installing Packages	408
Uninstalling Packages	409
Installing Role-Based Customizations	410
Importing Role-Based Custom Record Views	411
Importing Role-Based Custom Dropdown Lists	411
Sugar Portal	415
Overview	415
Configure Portal	416
Theme Portal	419
Layouts	420
Record View	420
List View	421
Workflow Management	422
Overview	422
Workflow Fields	423
Workflow Module Tab	424
Creating Workflows	424
Creating Via Workflow Module	425
Creating Via Duplication	426
Creating Workflow Conditions	427
Creating "After Time Elapsed" Workflow Conditions	427
Creating "When Record Saves" Workflow Conditions	428
Creating Workflow Alerts	429
Creating Workflow Actions	432
Workflow Action Types	432
Viewing Workflows	435
Viewing Via List View	435
Viewing Via Detail View	435
Viewing Via Recently Viewed	435
Searching Workflows	436
Basic Search	436
Advanced Search	437
Workflows List View	438
Pagination	438
Checkbox Selection	438
Column Sorting	439
Workflow Detail View	439

Actions Menu	439
Next or Previous Record	440
Conditions Subpanel	440
Alert Subpanels	441
Actions Subpanel	442
Editing Workflows	442
Editing Via Detail View	443
Editing Via List View	443
Deleting Workflows	443
Deleting Via Detail View	443
Mass Deleting Via List View	444
Workflow Alert Templates	444
Alert Template Fields	445
Creating Alert Templates	446
Creating Alert Templates Via Workflows Module	446
Creating Alert Templates Via Duplication	448
Inserting Variables	449
Viewing Alert Templates	450
Viewing Alert Templates Via List View	450
Viewing Alert Templates Via Detail View	451
Viewing Alert Templates Via Emails Module	451
Editing Alert Templates	451
Deleting Alert Templates	452
Time Intervals for Time Elapsed Workflows	452
Workflow Sequence	454
Products and Quotes	455
Overview	456
Working With Products- and Quotes-Related Modules	456
Product Catalog	459
Product Catalog Fields	460
Product Catalog Menus	462
Module Tab Menu	463
List View Menus	464
Mass Actions Menu	464
Record Actions Menu	465
Record View Actions Menu	465
Product Categories	466
Product Category Fields	466
Product Category Menus	467
Module Tab Menu	467
List View Menus	468
Mass Actions Menu	468
Record Actions Menu	469
Record View Actions Menu	470
Product Types	470

Product Type Fields	471
Product Type Menus	471
Module Tab Menu	471
List View Menus	472
Mass Actions Menu	472
Record Actions Menu	473
Record View Actions Menu	474
Ordering Product Types	474
Quotes Configuration	475
Manufacturers	476
Manufacturer Fields	476
Manufacturer Menus	477
Module Tab Menus	477
List View Menus	478
List View Mass Actions Menu	479
List View Record Actions Menu	479
Record View Actions Menu	480
Ordering Manufacturers	481
Shipping Providers	481
Shipping Provider Fields	481
Shipping Provider Menus	482
Module Tab Menus	482
List View Menus	483
List View Mass Actions Menu	483
List View Record Actions Menu	484
Record View Actions Menu	484
Ordering Shipping Providers	485
Tax Rates	485
Tax Rate Fields	486
Tax Rate Menus	486
Module Tab Menus	486
List View Menus	487
List View Mass Actions Menu	487
List View Record Actions Menu	488
Record View Actions Menu	489
Ordering Tax Rates	489
Bug Tracker	490
Overview	490
Release Fields	490
Release Module Tab	491
Creating Releases	491
Viewing Releases	492
Viewing Via Module	492
Editing Releases	493
Deleting Releases	494

SugarBPM	494
Overview	495
Scope	495
Prerequisites	495
Core Concepts	496
SugarBPM Modules	496
Basic Visual Notation Elements	499
Basic Steps to Automate a Business Process	502
Creating a SugarBPM Dashboard	503
Processes Dashlet	503
Process Definitions Dashlet	505
Process Email Templates Dashlet	507
Process Business Rules Dashlet	508
Process Management List View	510
Record Actions Menu	511
Preview	512
Searching Processes	513
Unattended Processes	514
Terminated vs. Cancelled Processes	516
Importing and Exporting SugarBPM Module Records	516
Exporting SugarBPM Records	517
Importing SugarBPM Records	518
SugarBPM Settings	520
SugarBPM Log Viewer	520
SugarBPM Scheduler	521
SugarBPM Blacklisted Fields	521
Process Definitions	521
Overview	521
Process Definition Fields	523
Fields Exclusive to Process Definition Design	524
Contact Source	525
Note Source	525
Pending Processing	525
Working With Process Definitions	526
Process Definition Menus	527
Module Tab Menus	528
List View Record Actions Menu	529
Record View Actions Menu	530
Process Definitions List View Dashlets	531
Pending Activities by Process	531
Process Summary Dashlet	532
Creating Process Definitions	532
Designing Process Definitions	534
Using the Visual Designer	534
Editing Tools	534
Process Validation	535

Comments	536
Sequence Flow	537
Adding Sequence Connectors	537
Removing Sequence Connectors	538
Moving and Deleting Design Elements	539
Evaluation Criteria Box	540
Process Definition Settings	541
Terminate Process	542
Locked Fields	543
Adding a Start Event	545
Adding Multiple Start Events	546
Adding Intermediate Events	548
Wait Events	548
Receive Message Events	550
Send Message Events	551
Working With Recipient Fields	553
Adding Recipients via Free Entry	553
Adding Recipients via User Menu	554
Adding Recipients via Recipient Menu	555
Adding Recipients via Teams Menu	556
Adding Recipients via Role Menu	556
Adding Form Activities	557
Forms Setting	557
General Tab	558
Read-Only Fields Tab	560
Required Fields Tab	561
Expected Time Tab	561
Users Setting	562
Static Assignment	563
Round-Robin	564
Self Service	564
Adding Actions	565
Business Rule	566
Assign User	567
Round Robin	569
Change Field	570
Advanced Configuration Options for Change Field Actions	572
Text Fields	572
Number Fields	573
Date Fields	574
User Fields	575
Add Related Record	575
Advanced Configuration Options for Add Related Record Actions	577
Text Fields	577
Number Fields	578

Adding Gateway Elements	580
Default Sequence Flows	582
Exclusive Gateways	583
Divergent Exclusive Gateway	583
Convergent Exclusive Gateway	585
Inclusive Gateways	585
Parallel Gateways	588
Divergent Parallel Gateway	588
Convergent Parallel Gateway	589
Event-Based Gateways	589
Adding End Events	590
Do Nothing	591
Terminate Process	591
Send Message	592
Setting Conditions	593
Creating Conditions for Events and Actions	593
Logical Operations	594
Module Field Evaluation	595
User Evaluation	596
Mathematical Operations	601
Calculating Dates	602
Fixed Date	602
Time Span	604
Sugar Date Variables	605
Creating Conditions for Activities and Gateways	606
Form Response Evaluations	606
Business Rule Evaluations	609
Exiting the Visual Designer	613
Returning to the Visual Designer	613
Enabling and Disabling Process Definitions	614
Enabling Process Definitions	614
Disabling Process Definitions	616
Process Business Rules	616
Overview	616
Process Business Rule Fields	617
Working With Process Business Rules	618
Process Business Rules Menus	620
Module Tab Menu	620
List View Record Actions Menu	621
Record View Actions Menu	622
Creating Process Business Rules	623
Designing Process Business Rules	625
The Rules Builder Interface	625
Creating Rule Sets	627
Condition and Conclusion Elements	627

Operator Elements	628
Process Email Templates	629
Overview	629
Process Email Template Fields	630
Working With Process Email Templates	631
Process Email Template Menus	633
Module Tab Menus	633
List View Record Actions Menu	634
Record View Actions Menu	635
Creating Process Email Templates	636
Designing Process Email Templates	637
The Design Toolbar	638
Using the Fields Selector Tool	640
Understanding Current and Old Values	643
Using the Record Link Selector Tool	643
Stock SugarBPM Templates	645
Overview	645
Viewing Stock SugarBPM Templates	645
Restoring Stock SugarBPM Templates	646
Stock Process Definitions	646
Sell Templates	646
Automatically update your sales forecast - Opportunities Only	647
Description	647
Configuration Notes	647
Automatically update your sales forecast - Opportunities With RLIs Part 1	647
Description	647
Configuration Notes	648
Automatically update your sales forecast - Opportunities With RLIs Part 2	648
Description	648
Configuration Notes	648
Route Lead and Create Follow-Up Task	649
Description	649
Configuration Notes	650
Stagnant Opportunity Reminder (Opportunities Only)	650
Description	650
Configuration Notes	651
Stagnant Opportunity Reminder (Opportunities with RLIs)	651
Description	651
Configuration Notes	651
Quote Approval When Discount Exceeds 20%	652
Description	652
Configuration Notes	652
Serve Templates	652
Case Follow-Up Date Management V2	653
Description	653
Configuration Notes	654

Case Status Update on Inbound Customer Note	654
Description	654
Configuration Notes	654
Customer Notification of Case Status Change	654
Description	655
New Portal User	655
Description	655
New Note Notification	655
Description	656
Tile View Settings	656
Overview	656
General Settings	656
General Settings Fields	657
Enabling and Disabling Tile View	657
Module Settings	657
Module Settings Fields	658
Configuring Tile View Column Headers	659
Configuring Tiles	660
Advanced Configuration Options	662
Overview	662
Maintenance Mode	662
System Configuration	662
Configuring File Permissions	663
Allowing POP Email Accounts	664
Security Options	664
Locking Down Admin Control	665
Locking Down Module Loader	665
Enabling Sites as Referers	666
Performance	666
Recommended Server Settings	666
Limiting System Resources	666
Configuring a Slave Database	667
Changing the Upload Directory	668
Changing the Cache Directory	669
Configuring Count Queries	669
Disabling Related Calculation Fields	669
Disabling Automatic Searches	670
Configuring Cron for Schedulers	671
Business Center Management	671
Overview	672
Business Center Fields	672
Working With Sugar Modules	673
Business Center Menus	674
Module Tab Menus	674
List View Menus	675

List View Mass Actions Menu	676
List View Record Actions Menu	676
Record View Actions Menu	677
Setting Business Hours	678
Business Holidays and Business Centers	678
Creating a Business Center Administrator	679
Employee Records	681
Overview	681
Employee Fields	681
Employees Module Tab	683
Creating Employees	684
Creating Via Employees Module	684
Creating Via Users Module	685
Creating Via Duplication	685
Viewing Employees	686
Viewing Via List View	686
Viewing Via Detail View	686
Viewing Via Recently Viewed	686
Searching Employees	687
Basic Search	687
Advanced Search	688
Employees List View	689
Pagination	689
Checkbox Selection	690
Actions Menu	690
Column Sorting	691
Employees Detail View	691
Next or Previous Record	691
Editing Employees	692
Editing Via Detail View	693
Editing Via List View	693
Deleting Employees	694
Exporting Employees	694
Mass Updating Employees	695
Knowledge Base Administration	696
Overview	696
Working With Sugar Modules	696
KB Template Menus	697
List View Menus	697
List View Mass Actions Menu	697
List View Record Actions Menu	698
Record View Actions Menu	699
Settings	699
Tag Management	701
Overview	701

Understanding Tag Behavior	701
Tag Fields	702
Working With Tags	702
Tag Menus	705
Module Tab Menus	705
List View Menus	706
List View Mass Actions Menu	707
List View Record Actions Menu	707
Record View Actions Menu	708
Consolidating Synonymous Tags	708
Creating a Tags Administrator	709
Console Management	711
Overview	711
Prerequisites	712
Designating a Console Administrator	712
Configuring the Consoles	713
Configuring the Overview Tab	714
Configuring the Module Tab Lists	714
Configuring the Module Tab Drawers	715

Sugar Serve 9.3 Administration Guide

This guide describes options that enable Sugar administrators to configure the application to meet their organization's requirements.

Last Modified: 2019-12-05 15:47:53

Introduction

Overview

Welcome to Sugar - a commercial Customer Relationship Management (CRM) application. Strong relationships are at the core of every organization's success. Sugar brings ease and order to the creation, development, and maintenance of your organization's important relationships.

Sugar consists of interrelated records in modules such as Accounts, Contacts, Opportunities, Cases, Meetings, Emails, etc. and wraps your data in an intuitive user interface which helps make sense of these different elements of your business. Whatever your organization's focus - sales, marketing, support, or other ventures - Sugar's flexible modules bend to align with your business' models and practices. Manage your relationships from inception to fruition and beyond with Sugar's built-in modules and relationships as well as your custom modules and configurations available to Sugar administrators.

Core Admin Features

- [User](#), [Password](#), [Team](#), and [Role](#) management to manipulate user access
- [Email](#) management to configure incoming and outgoing system email accounts and behaviors
- [System](#) management to control functional aspects and system-wide preferences within Sugar
- [PDF Manager](#) to create templates controlling the appearance of generated PDF files
- [Studio](#) to tailor existing modules to your organization's needs by adding or modifying fields, relationships, and layouts
- [Module Builder](#) to create new, custom modules as needed to fully match your organization's processes

Admin Wizard

Overview

Sugar offers administrators a wide range of configuration options to set up their account. Upon your initial log into Sugar, you will go through configuring some basic settings (i.e. Your Information, Your Locale, etc.) for your user profile. You may skip these steps and configure these settings in your user preferences at a later time. Once your user profile set up is complete, you will be able to navigate to a specific area of Sugar to perform various administrative functions (e.g. importing data, creating users, configuring the application via Studio, etc.) as well. Please note that system administrators can also set up each user's basic settings when creating a user in Sugar. This documentation will cover the various options available when first accessing your Sugar account.

Note: For instances that use SugarIdentity, the administrator will need to access [SugarIdentity](#) via the Cloud Settings console to create and manage [user records](#) as well as configure [password requirements](#) and set up [LDAP/SAML authentication](#).

Login Screen

The Sugar login screen is where you enter your login credentials (user name and password) to access your instance. Enter in your instance URL (e.g. <https://example.sugarondemand.com>) on your web browser to load Sugar's login screen. If you do not know your instance URL or login credentials, please reach out to another system administrator in your organization for assistance. Sugar's Admin Wizard will launch upon your first successful login allowing you to configure various system-wide settings as well as some personal settings.

Note: If your organization uses multiple [SugarIdentity-enabled instances](#) (e.g. production, sandboxes) and you have accessed different user accounts in the tenant(s) (e.g. ABC Production, ABC Test Sandbox), the login screen will display an [account selector](#) with the list of users you have logged in as for the current instance you are accessing.

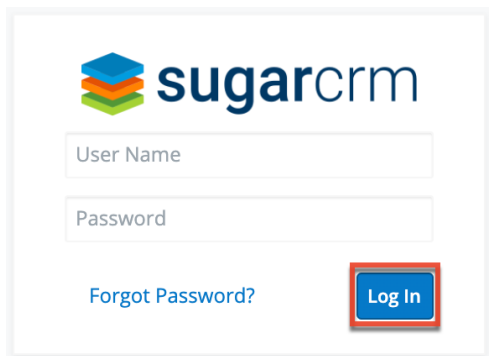

Note: If your instance has more active users than is allowed by your Sugar license, a warning is displayed on the login screen and regular users will not be able to log in. Admin users will be able to log in but will be redirected to the Users module. For more information, see the [Understanding User Types, License Types, and Sugar Licenses](#) article.

Language

Users have the option to choose the primary language they want to be displayed in Sugar by clicking the Language icon on the bottom right of the Login screen. The Language dropdown list will appear allowing you to select the appropriate language you want to be displayed in your Sugar account. The out-of-the-box default language in Sugar is English (US), but administrators can change the default language globally via Admin > Locale. For more information on configuring the default language in Sugar, please refer to the [Locale](#) section of the System documentation. Once the default language is changed, it will display as the default selection on the login screen for all users.

Please note that you must select the language that you want to be displayed each time you log in, otherwise the default language will display in Sugar.

Administrators can also configure what languages are available to select in the Language dropdown list via Admin > Languages. For more information on managing the available languages, please refer to the [Languages](#) section of the System documentation.

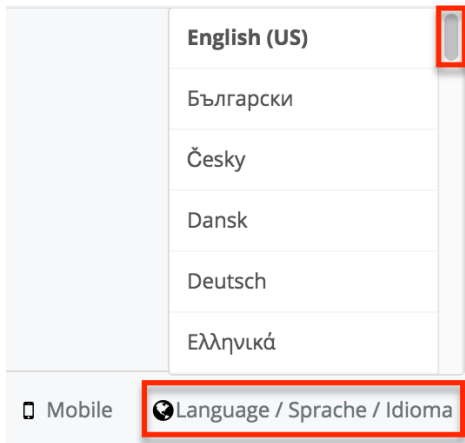

The following languages are available to display in Sugar:

Albanian	Hungarian
Arabic	Italian
Brazilian Portuguese	Japanese
Bulgarian	Korean
Catalan	Latvian
Chinese (Simplified)	Lithuanian
Chinese (Traditional)	Norwegian
Croatian	Polish
Czech	Portuguese
Danish	Romanian
Dutch	Russian
English (UK)	Serbian
English (US)	Slovak
Estonian	Spanish
Finnish	Spanish (Latin)
French	Swedish
German	Thai
Greek	Turkish
Hebrew	Ukrainian

Your Information

Once the Admin Wizard is completed, you will have the option to configure some of your personal settings via the User Wizard. The User Profile step is where you can enter key information (i.e. name, email address, and phone) about yourself to be stored in your user profile. Please note that the information you provide on this step can be updated in your user preferences at a later time if desired. For more information on configuring your personal information under user preferences, refer to the [Getting Started](#) documentation.

Note: For instances that use SugarIdentity, the User Profile step of the User Wizard is read-only and the displayed fields (e.g. First Name, Last Name) can only be edited in [SugarIdentity](#) via the Cloud Settings console.

The following options are available to configure your user profile:

- **First Name** : Enter your first name.
- **Last Name** : Enter your last name.
- **Email** : Enter your email address.
- **Office Phone** : Enter your office number.

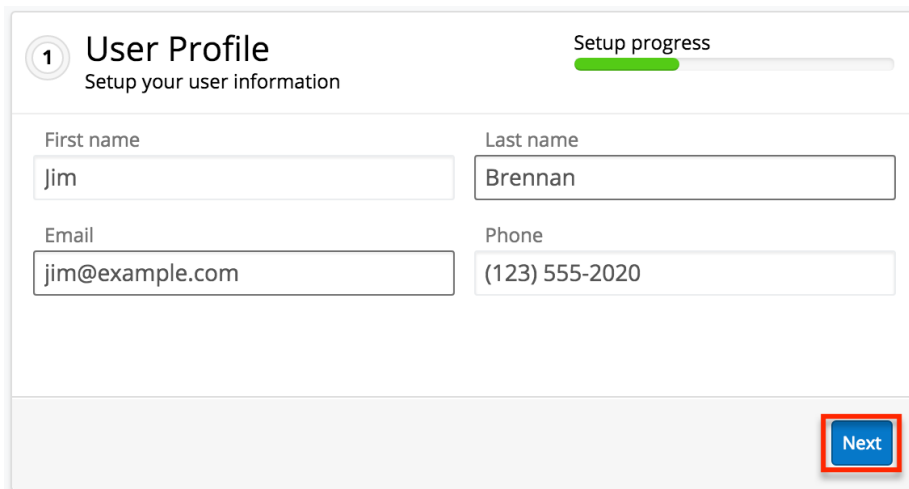

The screenshot shows the 'User Profile' step of the Admin Wizard. At the top left, there is a circled '1' and the text 'User Profile' with the subtitle 'Setup your user information'. To the right, a 'Setup progress' indicator shows a green bar that is approximately 25% full. Below this, there are four input fields arranged in a 2x2 grid: 'First name' (containing 'Jim'), 'Last name' (containing 'Brennan'), 'Email' (containing 'jim@example.com'), and 'Phone' (containing '(123) 555-2020'). At the bottom right of the form area, there is a blue 'Next' button with a red border.

Please note that all required fields will indicate "Required" in the field and must be completed prior to moving to the next step of the wizard. Once your personal information is entered, click "Next".

Your Locale

The Your Locale step is where you can configure the date, time, and name format you want to be displayed in Sugar based on your current geographical location. Please note that the information you provide on this page will override the system locale settings and can be updated in your user preferences at a later time if

desired. For more information on configuring your locale settings, please refer to the [Locale Settings](#) section of the Getting Started documentation.

The following options are available to configure your locale settings:

- **Time Zone** : Select the time zone based on your current location.
- **Date Format** : Select the format you want the date stamps displayed in Sugar.
- **Time Format** : Select the format you want the time stamps displayed in Sugar.
- **Name Format** : Select the format you want the concatenated name fields displayed in Sugar's list view and record view.

Once your locale information is entered, click "Next".

2 User Locale Settings Setup progress
Set your time zone, date, and name formats

Time Zone	Time Format
America/New York (GMT-5:00)	11:00PM
Date Format	Name Format
2010-12-23	Dr. David Livingstone

Back Next

The following page confirms that you are ready to use Sugar and allows you to perform various administrative functions (e.g. importing data, creating users, configuring the application via Studio, etc.). Selecting the action item(s) will take you directly to the specific area of the Admin page to create new users, import data from external sources, etc. Please note that you can click "Start Sugar" to go directly to your Sugar account if you wish to configure these settings at a later time.

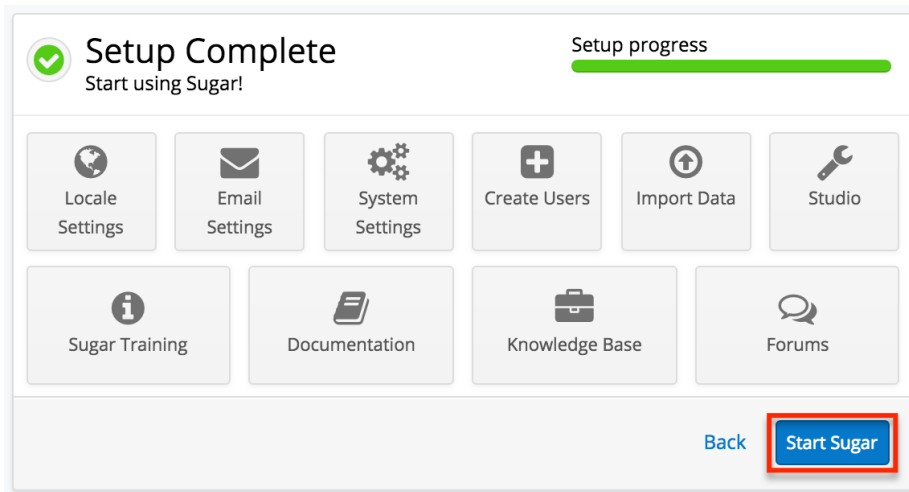

Last Modified: 2020-04-23 16:20:23

SugarCloud Insights

Overview

SugarCloud Insights allows administrators to easily monitor their instance's database and file system storage usage, license usage, as well as gain access to PHP error logs and access logs. Administrators can access the SugarCloud Insights page via Admin > SugarCloud Insights and will be able to view storage and license usage information such as the total amount of storage being used across their cloud instances, a breakdown of the current database and file system storage usage for each cloud instance, the total number of active users counting against their Sugar license, etc. In addition, administrators will have the ability to generate PHP error logs and access logs directly from the page which can help provide useful information when troubleshooting certain issues. For more information regarding the data provided on the SugarCloud Insights page, refer to the [SugarCloud Insights Guide](#).

Note: The SugarCloud Insights service is only available for SugarCloud customers.

Last Modified: 2019-12-05 15:47:53

Team Management

Overview

Team Management is used in Sugar to define permissions and groupings for users. These permissions cover what records a user is and is not able to access. Teams are used in conjunction with [Roles](#) to form a robust security model for non-admin users in Sugar. Users can use team settings on specific records to allow different users within Sugar the option to view these given records. Team settings can also be used as a form of organization, thereby separating records to be associated with specific teams for better tracking. Teams can be based on departments, geographic regions, or whatever else works best in a given organization.

Teams Module Tab

The Teams module tab can be accessed by navigating to the Administration page and clicking "Team Management" in the Users section. Once in the Teams list view, you can click the triangle in the Teams module tab to display the Actions and Recently Viewed menus. The Actions menu allows you to perform important actions within the module. The [Recently Viewed](#) menu displays the list of teams you last viewed in the module. Please note that clicking the module tab allows you to access the Teams list view.

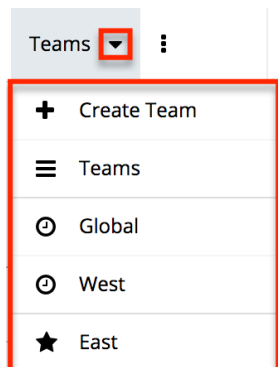

The Actions menu allows you to perform the following operations:

Menu Item	Description
Create Team	Opens the edit view to create a new team
Teams	Opens the list view layout to search and display teams

Team Types

From an administrative standpoint, teams will be handled differently based on their types. From a user standpoint, all teams will be treated pretty much the same. Each team type has their own special set of characteristics that aid in defining it. The team types defined as:

- [The Global Team](#)
- [Standard Teams](#)
- [Private Teams](#)

The Global Team

The Global team is created automatically when a Sugar instance is created. Global is the default team for all new users, and every user is a member of the team by default. Global is a universal team, so any records associated to the global team will be viewable by the users on this team. The global team is intended to be available for all users and a shared team for all users in Sugar.

Note: You cannot delete the Global team.

Standard Teams

Standard Teams can be created by administrators via Team Management. These are to be used throughout Sugar to organize and grant access on organizational specifics to your organization. Standard teams are often broken out into groups by departments, geographical regions, or duties. For example, you may have an East and West team, and also a Sales and Support team.

Private Teams

For every user that is created in Sugar, a corresponding private team is automatically created in the Teams module. By default, the private team name is the user's first and last name. A private team name will be updated any time the corresponding user's profile is edited and re-saved, even if the change was not made to the user's first or last name. For example, the private team for Jane Smith will be automatically named "Jane Smith". If the administrator edits private team "Jane Smith" to "Jane Smith-HR", and then user Jane Smith later updates the phone number on her user profile, Sugar will revert the private team name back to the

user's first and last name, "Jane Smith".

If your organization plans to edit private team names, you must disable the automatic update feature. Navigate to Admin > System Settings and select the checkbox next to "Prevent private team names from inheriting the user's name fields". For more information on this setting, please refer to the [System](#) documentation.

Note: Private teams are not deleted in the same method as other teams. For more information on deleting private teams, please review the [Deleting Teams](#) section of this guide.

Team Membership Types

Team memberships are given to users in one of two ways, either by an explicit or implicit membership. Regardless of the type, membership will control what records [regular users](#) are able to see. Each membership can be granted in different ways and can constitute different functionality. Team membership is represented in the team's [detail view](#), as well as the user's [detail view](#).

Note: Administrators do not adhere to team security and therefore can see all records.

Explicit team membership is forged when the relationship is defined from either the team's or user's detail view. In addition, explicit relationships are also represented with [private team](#) memberships. Explicit memberships, other than private teams, can be [removed](#) as necessary from the team's or user's detail view. Explicit memberships will also include membership functionality for actions such as [workflows](#) or [inbound email](#).

Implicit team membership is used for record visibility. Implicit membership relies on the "Reports To" field in the [User Profile](#). When one user reports to another, the hierarchy of the "Reports To" field is kept in tact. The user being reported to will inherit the team membership of the subordinate user and be able to see any records on both his or her own team, and the teams of which the subordinate user is a member. The subordinate's teams can either be explicit or implicit teams in this scenario.

Note: Implicit relationships cannot be removed, but the cause for their relationship can be broken by changing the reporting hierarchy.

In the Team's detail view, the user's subpanel will showcase which relationships are explicit and which are implicit. In the "Membership" column of the Users subpanel, the user will either be marked as a "Member", meaning that they are an

explicit member, or "Member Reports-to", meaning they are an implicit member. In addition, the users marked with the "Member Reports-to" will not include an "Unlink" button, as they have another user (or users) reporting to them on this team.

^ Users

Name	User Name	Membership	Email	Phone
Jim Brennan	jim	Member Reports-to	jim@example.com	
Will Westin	will	Member	will@example.com	unlink

Creating Teams

There are two methods that can be used to create teams in Sugar. These are via the Teams module tab's action list or by duplicating an existing team and then editing it. After initially creating the team, the administrator will need to associate users to the [newly created team](#).

For information on creating Private Teams, please review the [Repairing Teams](#) section of this documentation.

Creating Via Teams Module

The most common way to create a new team is via the Create Team option in the [Teams module tab](#). This opens up the edit view layout which allows you to enter in all the relevant information for the team.

Use the following steps to create a team via the Teams module:

1. Navigate to Admin > Team Management.
Note: The [Teams list view](#) will open displaying all existing teams that are currently available.
2. Click the triangle in the Teams module tab and select "Create Team".

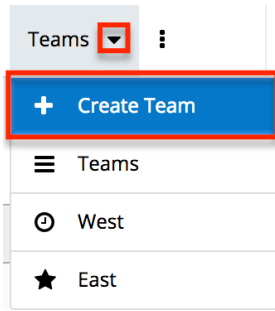

3. Enter a name and description of the team on the edit view screen that you are now presented with. Enter the appropriate values for fields in the edit view layout. All required fields are marked with a red asterisk and must be completed prior to saving.
4. On the team's detail view, [add users](#) that are members of this team.

Creating Via Duplication

You can also create a new team by duplicating an existing team. The Copy option is useful if the team you are creating has a similar set of members or a similar description to an existing team

Use the following steps to create a team by duplicating an existing record:

1. Navigate to a team record's detail view.
2. Click the Actions menu and select "Copy".

Teams: West

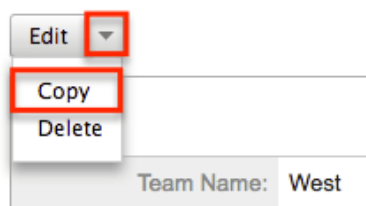

3. The displayed edit view is pre-populated with the original team's values. Update the name field, and description if need be, then click "Save".
4. On the team's detail view, [add any users](#) that are members of this team that are not on the original team, and [remove](#) any unwanted users.

Adding Users to Teams Via Teams Module

A user has to be associated to a team to be able to view records that are associated to the specific team. Assigning a team is much like any other many to many relationship in Sugar, where many users can be associated to one particular team, and one user can also be assigned to multiple teams. From Team Management, a

user can be associated to a team via the Users subpanel at the bottom of the detail view. To associate users to a team, follow the following steps:

1. Navigate to Admin > Team Management
2. From the Teams list view, select the team that you are working with
3. At the bottom of the page, click "Select User" from the Users subpanel



4. Use the popup search menu to search for and select the user(s) you would like to add to this team where you can either click on the user's name or, if selecting multiple users, click their corresponding checkboxes and then click "Select"

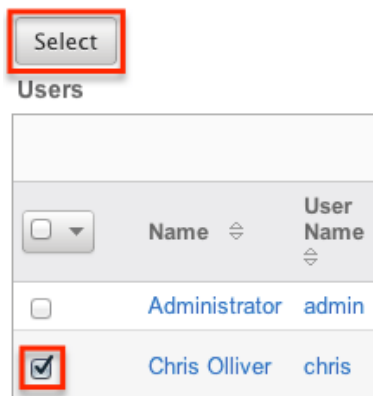

5. After selecting the user(s) the popup search box will close and the user(s) will now be displayed in the Users subpanel for the team to complete the relationship

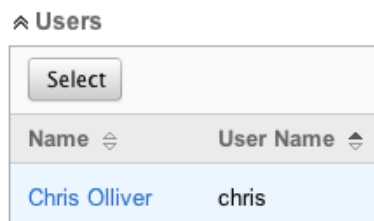

Adding Users to Teams Via Users Module

A regular user must be associated to a team to be able to view records that are associated to that team. Assigning a team is much like any other many to many

relationship in Sugar, where many users can be associated to one particular team, and one user can also be assigned to multiple teams. From User Management, a user can be associated to a team via the user's detail view. For more information on User Management, please refer to the [User Management](#) documentation. To associate a team to a user via User Management, follow the following steps:

1. Navigate to Admin > User Management
2. From the Users list view, open the user record that you would like to edit
3. From the user's detail view, click on the "Access" tab

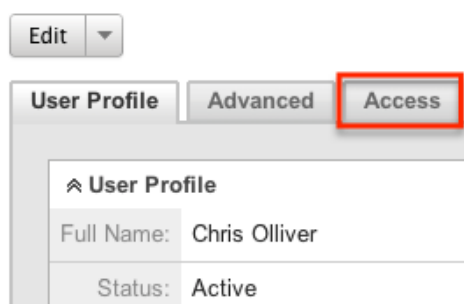

4. Scroll past the role chart to the "My Teams" subpanel and click "Select"

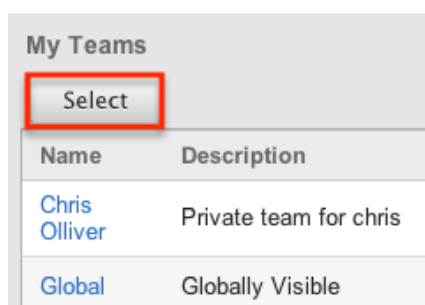

5. Use the popup search menu to search for and select the team(s) you would like to add to this user where you can either click on the team's name or, if selecting multiple teams, click their corresponding checkboxes and then click "Select"

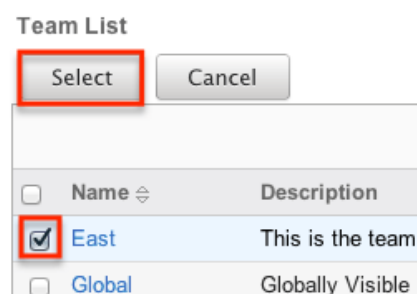

6. After selecting the team(s) the popup search box will close and the team(s) will now be displayed in the My Teams subpanel for the user to complete the relationship

My Teams	
<input type="button" value="Select"/>	
Name	Description
Chris Olliver	Private team for chris
East	This is the team for the East

Viewing Teams

There are various options available for viewing team records in Sugar including via the Teams list view, Teams detail view, Teams Last Viewed menu, from dashlets, and from reports.

Viewing Via List View

The Teams list view displays all team records meeting the current search criteria. To access the list view, simply navigate to Admin > Team Management. Alternately, if you are looking at a team's detail view, you can click the Teams module tab to return to the list view. You can click the team's name to open the record in detail view. For more information on viewing teams via list view, please refer to the [Teams List View](#) section of this documentation.

Viewing Via Detail View

The Teams detail view displays thorough team information showing the name and description of the team, followed by a subpanel of the users associated to the team. The detail view can be reached by clicking a team's link from anywhere in the application including from the Teams list view. For more information on viewing teams via detail view, please refer to the [Teams Detail View](#) section.

Viewing Via Recently Viewed

As you access different teams, Sugar will keep track of which teams you have recently viewed. Click the triangle in the [Teams module tab](#) to see a list of the 3 records you most recently viewed in the module. Clicking the record's name within the list will open it in detail view.

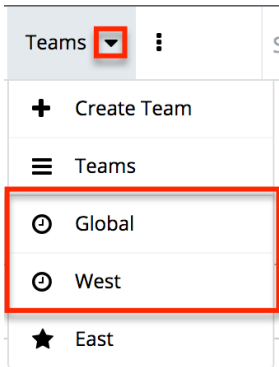

Viewing Via Dashlets

The Home page displays a collection of Sugar Dashlets which allow users to get a quick view of various records, activities, reports, etc. You can view team information in most module specific dashlets. Clicking a team's name from any dashlet will open the team in detail view. For more information on using dashlets, please refer to the [Dashlets](#) section of the Home documentation.

The image shows a 'My Calls' dashlet. It features a table with columns: Close, Subject, Related to, Start Date, Accept?, and Team. There are two records in the table. The first record has a subject 'Discuss review process', related to 'XY&Z Funding Inc', start date '03/18/2014 12:15pm', and team 'East'. The second record has a subject 'Bad time, will call back', related to 'Avery Software Co', start date '03/03/2014 02:15am', and team 'West+'. A red box highlights the 'East' and 'West+' team names in the 'Team' column.

Close	Subject	Related to	Start Date	Accept?	Team
	Discuss review process	XY&Z Funding Inc	03/18/2014 12:15pm		East
	Bad time, will call back	Avery Software Co	03/03/2014 02:15am		West+

Viewing Via Reports

Administrators have the option to build, run, and manage reports to gather key data from records within Sugar. When building a report, there are options to either run the report from the Teams module or add links to teams related to the records that are being reported on. Once the report is run, you will be able to view the team record's detail view by clicking the team's name in the report results. Please note that you can only directly access team detail views with Rows and Columns and Summation with Details-type reports as Summation and Matrix-type reports do not include hyperlinks in their display columns. For more information on using reports, please refer to the [Reports](#) documentation.

Name: Teams report
Modules: Teams, Teams > Users
Display Columns: Primary Team Name, Private, Description, User Name
Schedule: None
Filters: None

Primary Team Name	Private	Description
Administrator	<input checked="" type="checkbox"/>	Private team for admin
Jim	<input checked="" type="checkbox"/>	Private team for Jim
Global	<input type="checkbox"/>	Globally Visible

Searching Teams

The Teams list view search function searches for the name of the team to help you locate records easily and effectively. Once the search is performed, the relevant results will be displayed in the Teams list view below.

The buttons in the search panel have the following functions:

- **Search** : Click the Search button or press your Return/Enter key to perform the search
- **Clear** : Click the Clear button to clear all criteria from the searchable fields

To see all Team records, simply click "Clear" and then "Search" to perform a blank search with no name filter.

Search Teams

The screenshot shows a search panel with a text input field labeled "Team Name", a "Search" button, and a "Clear" button. Below these is a "Delete" button with a dropdown arrow. A red box highlights the "Team Name" input field, the "Search" button, and the "Clear" button.

Please note that Sugar automatically appends the wildcard character (%) to the end of your search phrase. This allows the system to retrieve all records that start with the keyword entered in the search. If you would like to broaden the search, you can use the wildcard at the beginning of your text as well (e.g. %Administrator). This will pull up any record that has the word "administrator" in the name, regardless of how it starts or ends.

For more information on using the various search methods as well as how

wildcards are used, please refer to the [Search](#) documentation.

Teams List View

The Teams list view displays all teams meeting the current search criteria, if any. You can view the name and description of each team within the field columns. Click on the name of the team to access the [detail view](#) for the team and review the settings further.

Pagination

List view displays the current search results broken into pages that you can scroll through rather than displaying potentially thousands of rows at once. To the right just below the search panel you can see which records of the total results set are currently being displayed. The two single-arrow Next and Previous buttons can be used to scroll through the records page-by-page. The two double-arrow First Page and Last Page buttons allow you to skip to the beginning or the end of your current results.

By default, Sugar displays 20 records per list view page, but administrators can change the number of records displayed via Admin > System Settings. For more information on changing the number of displayed records, please refer to the [System](#) documentation in the Administration guide.

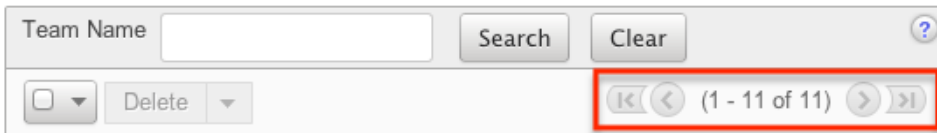

Checkbox Selection

Teams can be deleted in a mass-delete fashion via the list view by selecting all of the team records. To select individual team records on the Teams list view, mark the checkbox on the left of each row. To select or deselect multiple teams on the list view, use the options in the checkbox dropdown menu:

- **Select This Page** : Selects all records shown on the current page of results
- **Select All** : Selects all records in the current search results across all pages of results
- **Deselect All** : Deselects all records that are currently selected

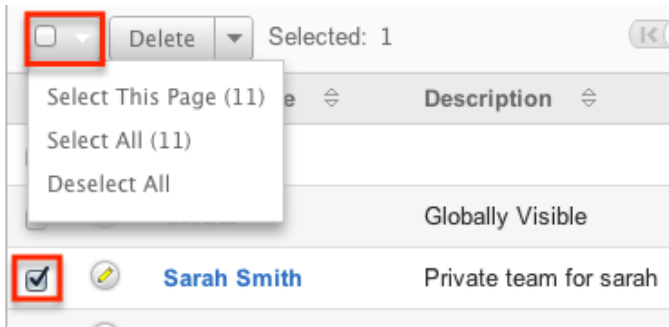

For more information on deleting teams, please refer to the [Deleting Teams](#) section of this documentation.

Actions Menu

The Actions menu to the right of the checkbox dropdown allows you to perform various actions on the currently selected records.

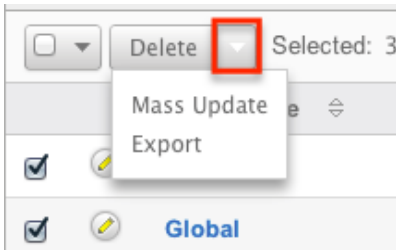

The options in the Actions menu allow you to perform the following operations:

Menu Item	Description
Delete	Delete one or more teams at a time
Mass Update	Mass update one or more teams at a time
Export	Export one or more teams to a CSV file

Column Sorting

List view provides the ability to sort all of the current search results by a field column in either ascending or descending order. To sort by a field or switch the sort direction, click the column header for either "Name" or "Description". The list view may be sorted by only one column at a time.



Teams Detail View

The Teams detail view displays thorough information about the team, as well as the ability to perform most actions related to team management. The detail view also includes a Users subpanel where users can be associated to the team and will therefore take on the team's properties.

Actions Menu

The Actions menu on the top left of each team's detail view allows you to perform various actions on the current record. Administrator users can change the action items to be displayed as separate buttons instead of a dropdown menu via Admin > System Settings. For more information on configuring the actions menu, please refer to the [System](#) documentation in the Administration guide.

Teams: West

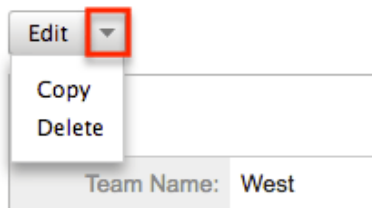

The options in the Actions menu allow you to perform the following operations:

Menu Item	Description
Edit	Edit the name and description of this team
Copy	Duplicate this team to create a new team
Delete	Delete this team

Users Subpanel

A user has to be associated to a team to be able to take on the team's membership

settings. Assigning a user is much like any other many to many relationship in Sugar, where many users can be associated to one particular team, and one user can also be assigned to multiple teams. From Team Management, a user can be associated to a team via the Users subpanel at the bottom of the page. To associate users to a team, follow the following steps:

1. Navigate to the detail view of the team that you would like to edit.
2. At the bottom of the page, click "Select User" from the Users subpanel

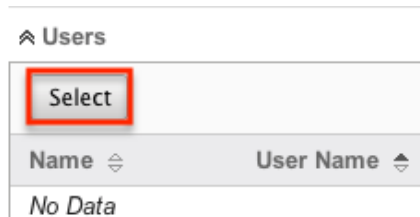

3. Use the popup search menu to search for and select the user(s) you would like to add to this team. You can either click on the user's name or, if selecting multiple users, click their corresponding checkbox and then click "Select"

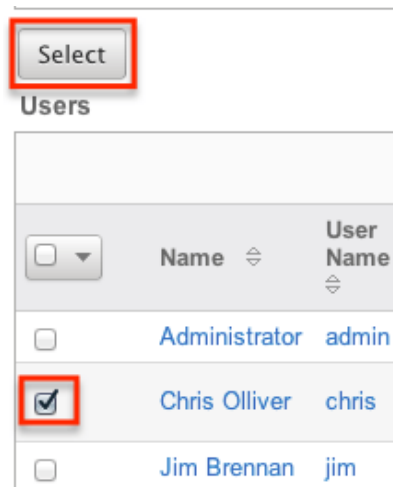

4. After selecting the user(s) the popup search box will close and the user(s) will now be displayed in the Users subpanel for the team to complete the relationship

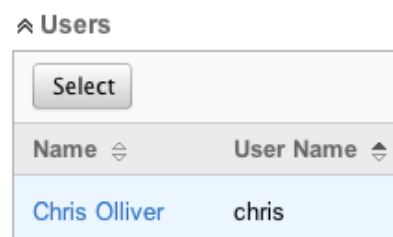

Next or Previous Record

On the upper right of the Teams detail view, there are two buttons that allow you to page through each team in the Teams list view's current search results. Clicking the Previous button displays the previous team of the current search results while clicking the Next button displays the next team of the current search results. The text in between shows which team result you are currently viewing within the total number of current results.

Teams: Chris Olliver



Editing Teams

Teams may be edited at any time to update or add information to the record or to edit existing information. You can make changes to existing team records via the Teams detail view and edit view, or from the Users module. Edit view is available within the Teams module and includes the Name and Detail fields.

Editing Via Detail View

You can edit teams via the detail view by clicking the Edit button on the upper left of the page. Once the edit view layout is open, update either the Name or Description fields, then click "Save" to preserve the changes made.

Teams: Chris Olliver

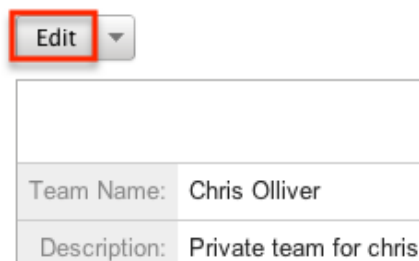

Editing Via List View

You can edit teams via the list view by clicking the Pencil icon to the left of each team's name. After clicking the pencil, the window will move to the edit view. Update the necessary fields, then click "Save" to preserve the changes. After saving from the edit view, you will be returned to the detail view for the record that you just updated. Because this method brings you to the edit view, the Name and Description fields can be updated.

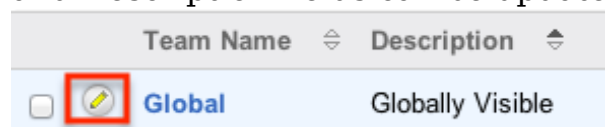

Editing Via Users Module

The Users module allows you to see all of the teams associated with a specific user in one place under the "Access" tab. The page will show the "My Teams" subpanel with a list of all of the teams associated with the user. For more information about viewing the teams from the Users module, please review the [User Management](#) documentation.

On the "My Teams" subpanel, there is an option to edit the team. After clicking the "Edit" button, the window will move to the edit view. Update the necessary fields, then click "Save" to preserve the changes. After saving from the edit view, you will be returned to the detail view for the record that you just updated. Because this method brings you to the edit view, only the Name and Description fields can be updated.



Deleting Teams

If a team record is invalid or is no longer being used in your organization's Sugar instance, it may be deleted from either the Teams detail view or list view. Deleting via the detail view allows you to delete a single record while the list view allows for mass deleting multiple records at once. Deleting team records will not delete any related user records and will only remove the relationship.

The exception to this is found when trying to delete any [private teams](#). Private teams are only able to be deleted when the user that the team is for has been deleted. To delete a private team, first delete the user via the user's detail view, following the steps from [User Management](#).

Deleting Via Detail View

Use the following steps to delete a team via the detail view:

1. Navigate to the team record's detail view.
2. Select "Delete" from the Actions menu.

Teams: West

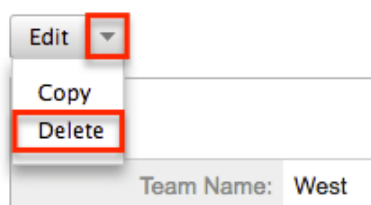

3. A pop-up message will display asking for confirmation. Click "Ok" to proceed.

Deleting Via List View

Use the following steps to delete one or more teams via the list view:

1. Navigate to the Teams list view by navigating to Admin > Team Management.
2. Use the [Search](#) functionality to search to find the Team records you wish to delete.
3. Select the desired team records individually or using the [checkbox dropdown's options](#).
4. Choose "Delete" from the Actions menu.

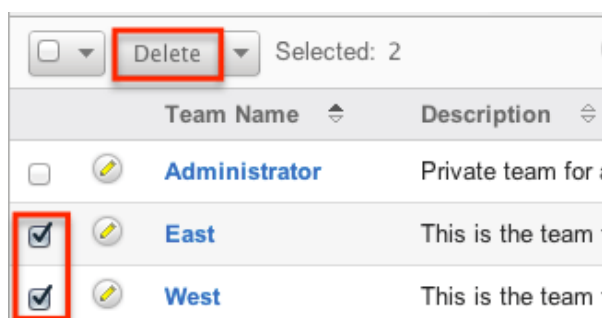

-
5. A pop-up message will display asking for confirmation. Click "Ok" to proceed.

Due to PHP memory limitations on the server, there may be occasions when the application times out while deleting a large number of team records. If you encounter an error when performing this action, we recommend selecting the records in smaller batches.

Removing Users From Teams

Users can be associated to multiple teams, and one team can also be associated to many users. As changes occur within an organization, there may be times that users need to be removed from specific teams. Breaking the relationship between a team and a user can be done both from the Teams detail view and from the Users detail view. Both modules include a subpanel to represent the relationship to the other module.

To remove a user from a team, use the following steps:

1. Navigate to the team record's detail view
2. Click "unlink" to the right of the user's row

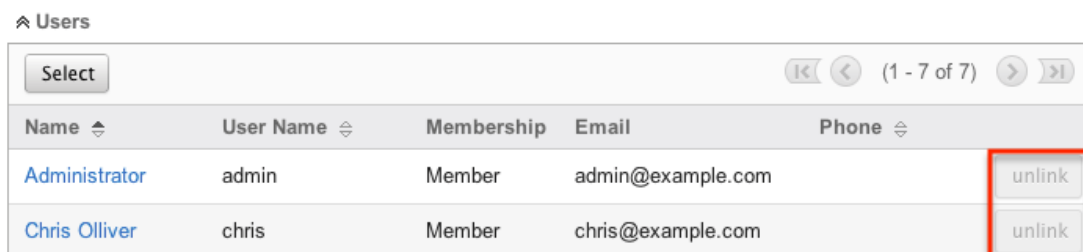

Name	User Name	Membership	Email	Phone
Administrator	admin	Member	admin@example.com	unlink
Chris Olliver	chris	Member	chris@example.com	unlink

3. A pop-up message will display asking for confirmation. Click "Ok" to proceed.

To remove a team from a user, use the following steps:

1. Navigate to the user's detail view
2. From the user's detail view, click on the "Access" tab

Chris Olliver



3. Scroll past the role chart to the "My Teams" subpanel and click "Remove" on the row of the team you would like to remove

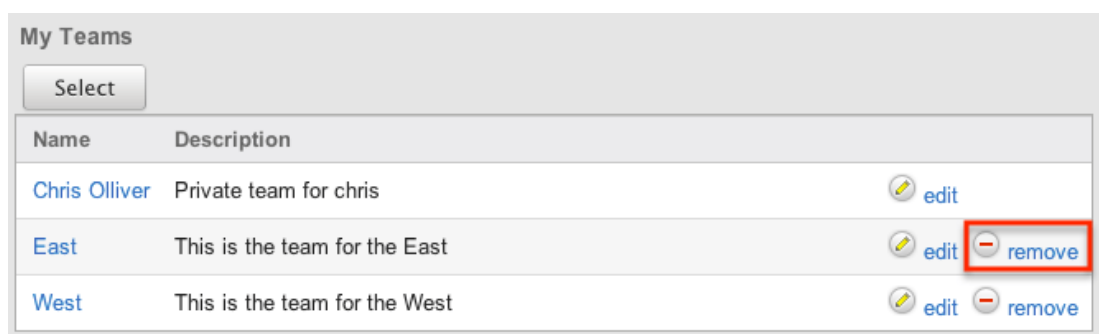

4. A pop-up message will display asking for confirmation. Click "Ok" to proceed

Repairing Teams

Sugar's Repair menu includes two options for administrators to improve team structures and functionality. These processes should not be needed often, and are only used when the necessary changes are to be made. The repair options are as follows:

Type	Description
Upgrade Teams	Checks to make sure that all users have associated private teams
Repair Teams	A combination of four different repair functions to rebuild team accesses

Last Modified: 2019-12-05 15:47:53

Role Management

Overview

Roles in Sugar determine which users can access modules as well as which operations the users are allowed to perform within those modules. When configuring role settings in Sugar, an administrator may choose to enforce restrictions for entire modules or for selected fields on the records in a module, as explained in the following sections. To fully leverage Sugar's security model, both permission types can be used together for a given role and should be considered in conjunction with the [Team Management](#) settings used by your organization.

Administrators have the ability to create different roles and assign regular users to the roles. A user can be related to any number of roles, and when multiple roles or role settings are applied, Sugar adheres to a most-restrictive policy to determine the user's appropriate access levels. Administrators cannot be related to roles, as their administrative rights supersede any restrictions imposed by Role Management. For more information on System Administrator users, please review the [User Management](#) documentation.

Roles control multiple layers of actions and access for users within Sugar:

- [Module-Level Permissions](#)
- [Record-Level Permissions](#) (i.e. Team-Based Permissions)
- [Field-Level Permissions](#)

Exceptions

The following modules respond uniquely to role settings in Sugar:

- **Forecasts Module** : For the Forecasts module, roles will allow or deny access at the module level with no further layers of access. Because the Forecasts module uses data from the Opportunities, Products, Quotas, Worksheet and Time Period modules, the Forecasts module does not respect the module- or field-level ACLs for those modules. For example, the opportunity data that is shown in the Forecasts module worksheets will be displayed and editable regardless of whether or not the user has access to the Opportunities module or has field-level restrictions in that module.
- **Reports Module** : Sugar's Reports module does not respect certain field-level role restrictions, meaning that generated reports may display field

data for which a user's role is set to restrict visibility.

Roles Module Tab

The Roles module tab can be accessed by navigating to the Administration page and clicking "Role Management" in the Users section. Once in the Roles list view, you can click the triangle in the Roles module tab to display the Actions and Recently Viewed menus. The Actions menu allows you to perform important actions within the module. The Recently Viewed menu displays the list of roles you last viewed in the module. Please note that clicking the module tab allows you to access the Roles list view.

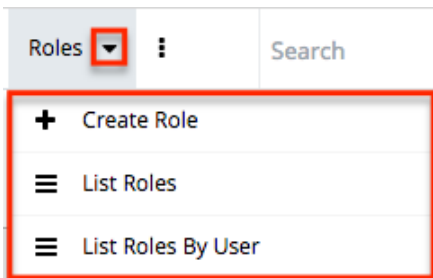

The Actions menu allows you to perform the following operations:

Menu Item	Description
Create Role	Opens the edit view to create a new role
List Roles	Opens the list view layout to search and display roles
List Roles By User	Opens a page for viewing each user's access according to their combined roles

Creating Roles

Sugar's roles specify which users can access modules, as well as which operations the users are allowed to perform within those modules. When configuring role settings in Sugar, an administrator may choose to enforce restrictions for entire modules or for selected fields on the records in a module, as explained in the following sections. To fully leverage Sugar's security model, both permission types can be used together for a given role and should be considered in conjunction with the team access settings used by your organization.

Creating Roles via Role Management

The most common way to create a role is via the Create Role option in the Role Management module tab. This opens up the edit view layout which allows you to enter in all the relevant information for the role.

Use the following steps to create a role via Role Management:

1. Navigate to Admin > Role Management.
 - **Note:** The [Roles list view](#) will open displaying all existing roles that are currently available.
2. Click the triangle in the Roles module tab and select "Create Role".

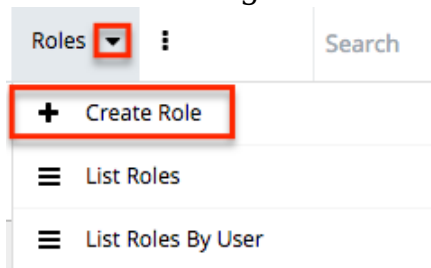

3. Enter the appropriate values for fields in the edit view layout. All required fields will indicate "Required" in the field and must be completed prior to saving.
4. On the Role Chart screen, configure the [module](#) and [field permissions](#), and [assign users to the role](#).

Creating Roles via Duplication

You can also create a new role by duplicating an existing role. The duplicate option is useful if the role you are creating has similar information to an existing role.

Use the following steps to create a role by duplicating an existing record:

1. Navigate to a role record's detail view.
2. Click the Actions menu and select "Duplicate".



3. The displayed edit view is pre-populated with the original role's values. Update the necessary fields, then click "Save".
4. On the Role Chart screen, update the [module](#) and [field permissions](#), and [assign users to the role](#).

Setting Module-Level Permissions

Sugar's Role Chart contains ten columns and has a row for each module down the left-hand side. The columns represent an access level or a type of operation within Sugar, and the corresponding points between the columns and module rows define the role's permission setting for the operation within the given module.

	Access	Access Type	Delete	Edit	Export	Import	List	Mass Update	View
Accounts	Enabled	Admin & Developer	Not Set	Not Set	Not Set	Not Set	Not Set	Not Set	Not Set
Bugs	Enabled	Normal	None	Owner	Not Set	Not Set	Not Set	Not Set	Not Set
Calls	Enabled	Normal	Not Set	Not Set	Not Set	Not Set	Not Set	Not Set	Not Set

To configure or make changes to a role, follow the steps below:

1. On the Role Chart, find the intersection of the operation and the module that you would like to adjust and click inside the corresponding table cell.
2. A dropdown list displays the options available for that configuration. Select the appropriate security option based on the [access and operation definitions](#) explained later on this page.

Save Cancel

	Access	Access Type	Delete	Edit	Export
Accounts	Enabled	Admin & Developer	All Owner	Not Set	Not Set
Bugs	Enabled	Admin & Developer	✓ Not Set None	Not Set	Not Set
Calls	Not Set	Not Set	Not Set	Not Set	Not Set

3. Repeat steps 1 and 2 for any other fields you would like to change in this module for the current role.
4. When complete, click "Save" to secure the changes.

Note: The most restrictive role setting always takes precedence when Sugar has to choose between two or more settings.

The following table explains the Role Chart's components in detail. Please scroll [beyond this table](#) for descriptions of each configuration option.

Role Chart Column Header	Configuration Options	Description	Additional Comments
Module (blank header row)	N/A	Identifies which module the row's settings will affect	

Access	<ul style="list-style-type: none"> • Enabled • Not Set • Disabled 	Controls access to the entire module for users in this role	When access to a module is disabled, the user is prohibited from viewing any records in this module. They cannot see a tab for the module in the navigation bar, and other module records do not reveal this module's subpanel to the user. For more information, please refer to the Module Access definitions below this table.
Access Type	<ul style="list-style-type: none"> • Normal • Not Set • Admin • Developer • Admin & Developer 	For enabled modules, Access Type determines how much control users in this role have over the module	Please refer to the Module Access Type definitions below this table.
Delete	<ul style="list-style-type: none"> • All • Owner • Owner & Selected Teams* • Not Set • None 	Restricts users from deleting or merging records in this module	Restricting a user's ability to delete records also restricts a user's ability to merge records in the module since merging results in deleting one or more records.
Edit	<ul style="list-style-type: none"> • All • Owner • Owner & Selected Teams* • Not Set • None 	Restricts users from editing, creating, or merging records in this module	Although it is labeled "Edit", this role setting also affects the Create functionality because the process of creating a record functions

			the same way as editing. It also restricts the merge functionality in Sugar, which modifies existing records.
Export	<ul style="list-style-type: none"> • All • Owner • Owner & Selected Teams* • Not Set • None 	Restricts users from exporting data from this module to their local computers	This role setting affects usage of the Sugar API, which is the framework used for external connections, such as the Outlook Plug-in. For more information on exporting, please refer to the Export documentation in the Application guide.
Import	<ul style="list-style-type: none"> • All • Not Set • None 	Restricts users from importing data into this module	This role setting affects usage of the Sugar API, which is the framework used for external connections, such as the Outlook Plug-in. For more information on importing, please refer to the Import documentation in the Application guide.
List	<ul style="list-style-type: none"> • All • Owner • Owner & Selected Teams* • Not Set • None 	Restricts a user's ability to see records in a list view or subpanel	A module's list view is not visible to users where "List" is set to "None".
Mass Update	<ul style="list-style-type: none"> • All • Not Set • None 	Restricts users from using the Mass Update	The Mass Update option is not visible on the list view's

		functionality in this module's list view	Actions menu when "Mass Update" is set to "None". If "List" is set to "None", the Mass Update configuration is inconsequential. To entirely prohibit users in a role from updating many records at once, set "Import" to "None" as well to prevent mass updates via import.
View	<ul style="list-style-type: none"> • All • Owner • Owner & Selected Teams* • Not Set • None 	Restrict access to the record view which displays an individual record's details	<p>When "View" is set to "None", the module's list view displays record's names, but the names are not hyperlinked to their corresponding record views like they are for users with the View permission enabled.</p> <p>When a module's View setting is "None" or "Owner", the access level for "Edit" and "List" must be set to the same value to ensure desired functionality for Sugar Mobile and other API-based applications.</p>

*The Owner & Selected Teams option only appears for modules using team-based permissions. For more information, please refer to the [Enabling Team-Based](#)

[Permissions](#) section of this page.

The following sections explain the various configuration options available in the Role Chart.

Module Access Definitions

The Access column provides the following options:

- **Enabled** : The user can access this module in Sugar.
- **Not Set** : The user is neither restricted nor granted access to this module. When permission is "Not Set", the users within this role default to "Enabled" access.
- **Disabled** : The user cannot access this module, view any of its records, or see any trace of its existence in Sugar.

Module Access Type Definitions

The Access Type column provides the following options:

- **Normal** : The user can perform standard functions in this module barring restrictions from other roles or team settings. The user cannot access the Administration functions for this module.
- **Not Set** : The user is neither restricted nor granted access to this module. When permission is "Not Set", users within this role default to "Normal" access.
- **Admin** : The user is not subject to any [Teams](#) restrictions for this module and can view all records, barring other role restrictions. Admin access also forces "All" access for that module's action-related columns (e.g. Edit, Delete, etc.) if the row's operation-related columns remain "Not Set". However, any more restrictive options you may choose will supersede the Admin access. Please note that the module-level Admin access type does not grant access to the Administration functions for this module.
- **Developer** : The user has access to the module-specific sections of Studio, Workflow Management, Dropdown Editor, and any other Administration functions that are specific to the module. The user's access to Sugar records is not affected; access remains subject to [Teams](#) restrictions and action-related role restrictions for this module. For more information on developer tools, please refer to the [Developer Tools](#) documentation.
- **Admin & Developer** : The user is not subject to any [Teams](#) restrictions for this module and can access Administration functions for this module. For more information, please refer to the descriptions for the "Admin" and the

"Developer" access types above.

For more information on Admin, Developer, and Admin & Developer roles, please refer to the article [Understanding Admin and Developer Access in Roles](#).

Record Operation Definitions

The operation columns (e.g. Edit, Delete, etc.) provide the following configuration options:

- **All** : The user can perform this action on any and all records that they can access in Sugar per their team memberships.
- **Owner** : The user can perform this action only if they are the "Assigned To" user on the record.
- **Owner & Selected Teams** : The user can perform this action if they are the "Assigned To" user on the record or if they belong to team which is designated as having extra access on the record. This option is only visible if an administrator has enabled [team-based permissions](#) for the module.
- **Not Set** : The user is neither restricted nor granted access to this function. When permission is "Not Set", users within this role default to "All" access.
- **None** : The user cannot perform this action on any records within this Sugar module.

Note: When using the Owner & Selected Teams setting, any user with permission to edit the Teams field can extend role permissions to other users. To maintain a tighter security model, we recommend using this setting in conjunction with [field-level access control](#) on the Teams field to regulate who can edit the teams on a record.

Setting Record-Level Permissions

In Sugar, teams are typically used to control which groups of users can access a record. Using the record-level, team-based permissions, however, an administrator may choose to extend the purpose of teams to control who can perform certain operations on the record (e.g. edit, delete, etc.). When enabled, regular users can use a record's Teams field to grant access such as viewing, editing, exporting, importing, and deleting permission to specific users or user groups.

For more information on teams, please refer to the [Team Management](#) documentation.

Enabling Team-Based Permissions

An administrator may decide to enable record-level, team-based permissions for none, some, or all of the modules in a Sugar instance. Once enabled, the administrator can build roles that utilize the new access option (Owner & Selected Teams).

Follow these steps to enable the team-based permission capability:

1. Navigate to Admin > Team-based Permissions.

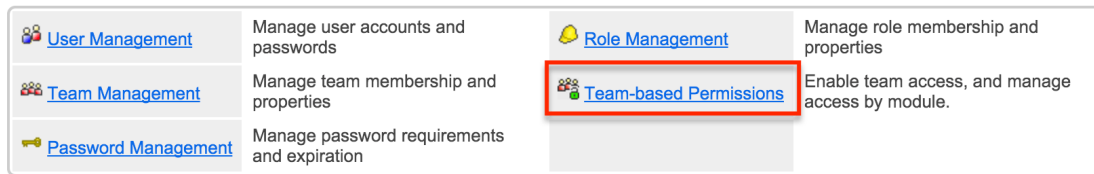

2. If an administrator has never enabled team-based permissions for this instance, the configuration page will open and display a warning message above a disabled checkbox. Click on the checkbox labeled "Enable team-based permissions" to select the modules you want to enable. If the checkbox is already selected, you will see the modules listed prominently on the configuration page.
3. Place a checkmark in the boxes next to modules that should support team-based permissions. The square behind the module name changes from gray (disabled) to blue (enabled) upon selecting the checkbox. Once you are satisfied with your selections, click "Save" to preserve the changes.

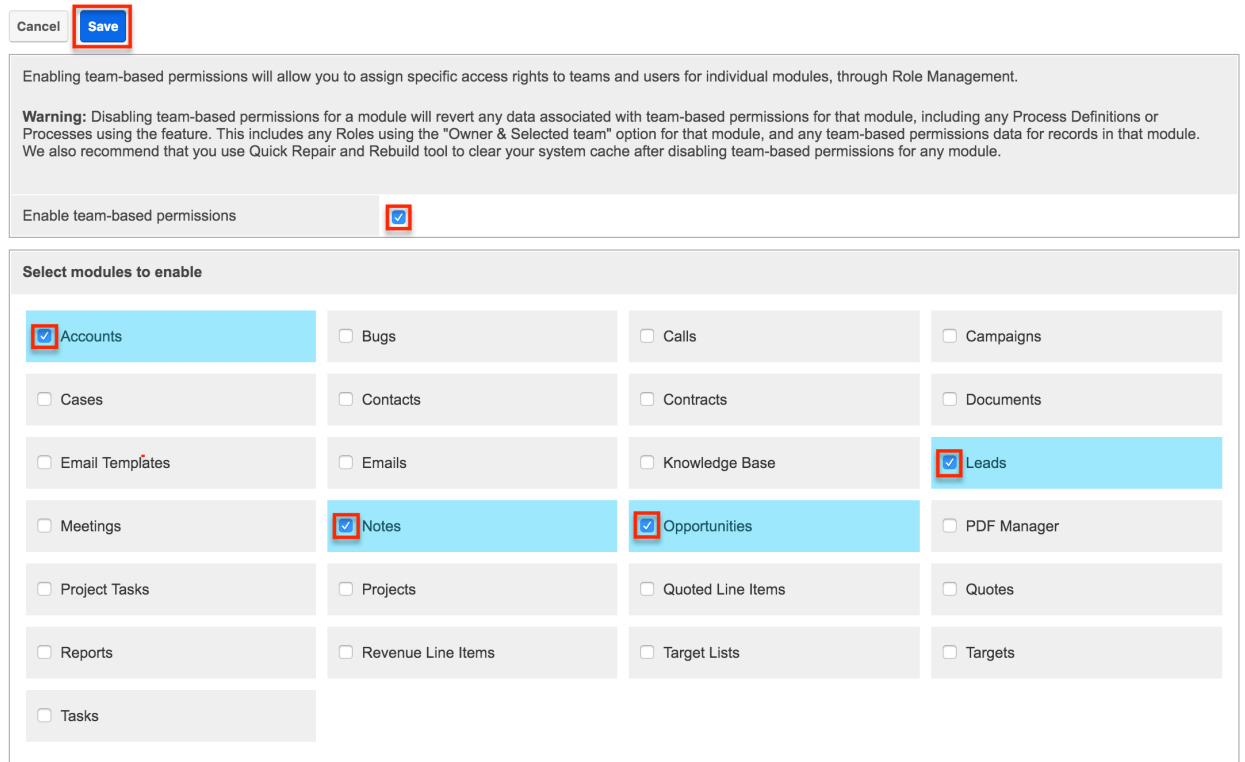

After saving, you can confirm that a module has been enabled for team-based permissions by clicking "Edit" on any record within the module and viewing the Teams field. Each team's name in the widget should include a Lock button, defaulted to a disabled (white) state.



If the Teams widget does not show the Lock buttons, confirm that you properly saved the admin settings in step 3, perform a [Quick Repair and Rebuild](#), and try refreshing your browser's cache.

You may now create roles that utilize the "Owner & Selected Teams" access type for actions in the enabled modules. Please note that team-based permissions have no effect on Sugar until users have been assigned to roles that are configured with "Owner & Selected Teams" access. For more information, please refer to the Record Operation Definitions section of this page. For information on using team-based permissions on a record, please refer to the [User Interface](#) documentation.

Disabling Team-Based Permissions

Disabling team-based permissions for a module permanently removes any data associated with team-based permissions for that module. Any role definitions using the "Owner & Selected Team" option for field-access settings or operations in that module revert to the more restrictive setting, "Owner". All record-level, team-based permissions data for that module are also permanently deleted. Sugar will not remember a record's role-related team settings if you ever wish to re-enable the module for team-based permissions.

To disable team-based permissions for a module, navigate to Admin > Team-based Permissions, uncheck the box next to the appropriate module's name, and click "Save". To disable the functionality for the entire instance, simply uncheck the box labeled "Enable team-based permissions" and click "Save". After disabling team-based permissions for any module, please use the [Quick Repair and Rebuild](#) tool to clear your system's cache.

Setting Field-Level Permissions

Role Management also provides the option to set permissions and restrictions on specific fields within modules. To change the field-level permissions for a role, follow these steps:

1. Navigate to Admin > Role Management.
2. Create and save a new role or select an existing role to edit.
3. On the left side of the screen, click on the name of the module that contains the field(s) you would like to restrict.

All	Save	Cancel
Accounts		
Bugs		
Calls		
Cases		
Contacts		
Contracts		
Documents		

	Access	Access Type
Accounts	Not Set	Not Set
Bugs	Not Set	Not Set
Calls	Not Set	Not Set
Campaigns	Not Set	Not Set

4. On the next screen, find the field that you would like to restrict and then click inside the table cell to the right of that field name. In this example, click on the words "Not Set" next to the word "Type" to edit access to the Type field.

Field Permissions

Type +	Not Set	Annual Revenue +	Not Set
Campaign +	Not Set	Created By +	Not Set
Email +	Not Set	Email Address +	Not Set
Employees +	Not Set	Facebook Account +	Not Set

Note: Some fields may be part of a group and the access setting will affect all of the fields in the group. To see which fields, if any, are in a group with the field you are editing, click the Plus (+) sign next to the field's name. Any fields listed as part of a group will also be restricted at the level you choose. Grouped fields cannot be controlled independently. If you cannot find the field that you would like to restrict in the fields table, it may be grouped within another field. Try expanding fields that are likely to be grouped with the field you are looking for (e.g. the Billing City field for Accounts is grouped under the Billing Street field as part of the billing address group).

5. From the dropdown list, select a level of field access for this role's members based on the [field-access definitions](#) explained below.

Field Permissions

Type +	<input checked="" type="checkbox"/> Not Set <input type="checkbox"/> Read/Write <input type="checkbox"/> Read/Owner Write <input type="checkbox"/> Read Only <input type="checkbox"/> Owner Read/Owner Write <input type="checkbox"/> None	Annual Revenue +	Not Set
Campaign +		Created By +	Not Set
Email +		Email Address +	Not Set
Employees +		Facebook Account +	Not Set

6. Repeat steps 4 and 5 for any other fields you would like to change in this module for the current role.
7. When complete, click "Save" to secure the changes.

Field Access Definitions

-
- **Not Set** : The user is neither restricted nor granted access to this field. When permission is "Not Set", users within this role default to "Read/Write" access.
 - **Read/Write** : The user can see the value of this field and can edit it.
 - **Read/Owner Write** : The user can see the value of this field but can only edit the field's value if they are the "Assigned To" user on the record.
 - **Read/(Owner & Selected Teams) Write** : The user can see the value of this field but can only edit the field's value if they are the "Assigned To" user on the record or if they belong to a team which is designated as having extra access on the record. This option is only visible if an administrator has enabled team-based permissions for the module.
 - **Read Only** : The user can see the value of this field but cannot change its value.
 - **Owner Read/Owner Write** : The user can only see and edit this field if they are the "Assigned To" user on the record.
 - **(Owner & Selected Teams) Read/Owner Write** : The user can only see the value of this field if they are the "Assigned To" user on the record or if they belong to team which is designated as having extra access on the record, but they can edit the field only if they are the "Assigned To" user on the record. This option is only visible if an administrator has enabled team-based permissions for the module.
 - **(Owner & Selected Teams) Read/(Owner & Selected Teams) Write** : The user can only see the field and edit the field's value if they are the "Assigned To" user on the record or if they belong to a team which is designated as having extra access on the record. This option is only visible if an administrator has enabled team-based permissions for the module.
 - **None** : For Sidecar modules, the user can see this field on layouts (e.g. Record View) but cannot see its value. Instead, Sugar displays "No Access" as the field's value. For Legacy modules (e.g. Quotes), the user cannot see the field on any layout. Instead, Sugar displays a blank space on the edit and detail views.

Assigning Users to Roles

A user must be associated with a role to take on the role's permission settings. Assigning a role is much like any other many-to-many relationship in Sugar, where many users can be associated with any particular role, and one user can also be assigned to multiple roles.

If a user is assigned to multiple roles, the most restrictive option for each setting is respected. For example, if a user is assigned to two roles, one which restricts Edit access for the Accounts module to "Owner" and the second which restricts it to "Owner & Selected Teams", the "Owner" setting will be respected. View the Access

tab on each user's profile to see the cumulative effect of all of their assigned roles.

Assigning Roles via Role Management

From Role Management, a user can be related to a role via the Users subpanel at the bottom of the detail view. To relate users to a role, use the following steps:

1. Navigate to Admin > Role Management.
2. From the Roles list view, select the desired role.
3. At the bottom of the page, click "Select User" from the Users subpanel .



4. Use the pop-up search menu to search for and select the user(s) you would like to add to this role where you can either click on the user's name or, if selecting multiple users, click their corresponding checkbox and then click "Select".

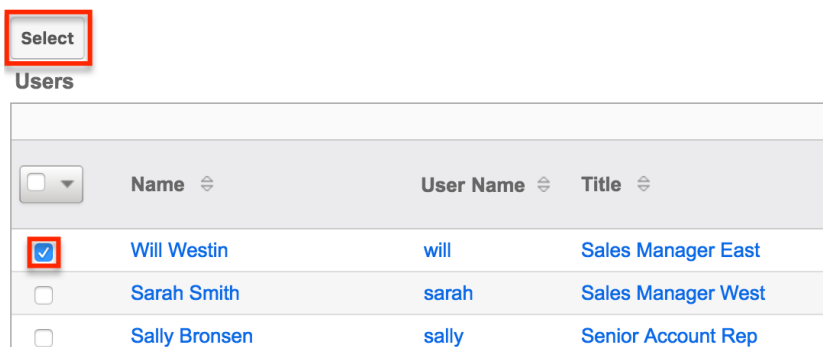

After selecting the user(s), the pop-up search box will close and the user(s) will now be displayed in the Users subpanel for the role to complete the relationship.

Assigning Roles via User Management

From User Management, a user can be related to a role via the user's detail view. For more information on User Management, please refer to the [User Management](#) documentation. To relate a role to a user via User Management, follow the following steps:

1. Navigate to Admin > User Management.
2. From the Users list view, open the user record that you would like to edit
3. From the user's detail view, click on the "Access" tab

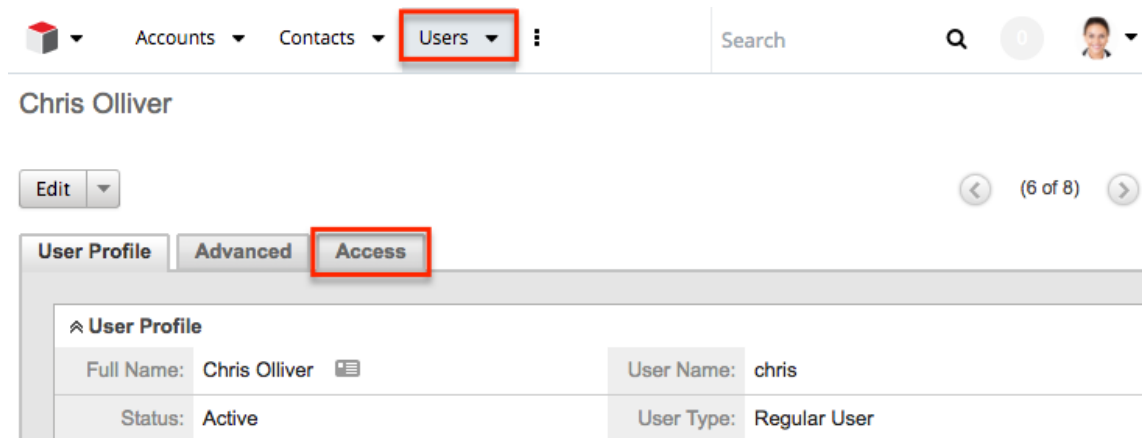

4. Scroll past the Role Chart to the subpanel for "Roles" and click "Select"



5. Use the pop-up search menu to search for and select the role(s) you would like to add to this user where you can either click on the role's name or, if selecting multiple roles, click the corresponding checkboxes and then click "Select"

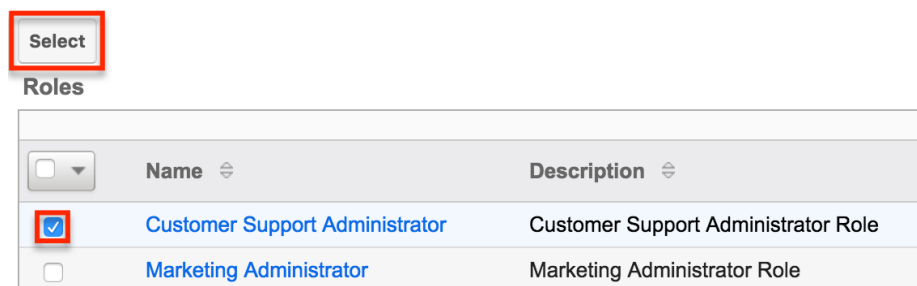

After selecting the role(s), the pop-up search box will close and the role(s) will now be displayed in the Roles subpanel for the user to complete the relationship.

Viewing Roles

There are various options available for viewing role records in Sugar including via the Roles list view, Roles detail view, Roles Recently Viewed menu, the List Roles by User function, and from the Users module.

Viewing via List View

The Roles list view displays all role records meeting the current search criteria. To access the list view, simply navigate Admin > Role Management. Alternately, if you are looking at a role's detail view, you can click the Roles module tab to return to

the list view. You can click the role's name to open the record in detail view. For more information on viewing roles via list view, please refer to the [Roles List View](#) section of this documentation.

Viewing via Detail View

The Roles detail view is where all of the modifications to the role settings can be made. This page includes the name and description of the role, the chart where module settings can be manipulated, links to the field-level action settings, and the Users subpanel where users can be added to the role. For more information on viewing roles via detail view, please refer to the [Roles Detail View](#) section of this documentation.

Viewing via Recently Viewed

As you access different roles, Sugar will keep track of which roles you have recently viewed. Click the triangle in the [Roles module tab](#) to see a list of the 3 roles you most recently viewed in the module. Clicking the role's name within the list will open it in detail view.

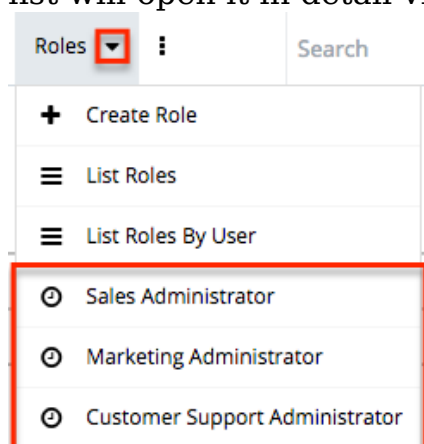

Viewing Roles by User

Role Management offers the option to view all roles assigned to specific users. Click the triangle in the Roles module tab and select "List Roles By User" to view these roles.

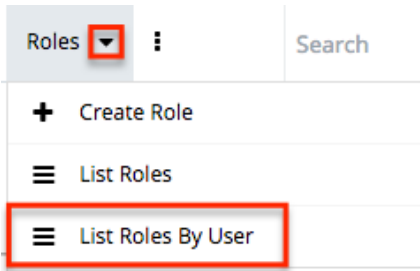

You will be redirected to the [Users](#) module and a screen will appear with a dropdown list with all users' names included. Select the user you would like to view and a chart will show which is a compilation of all of the roles listed for the user in the Roles subpanel, at the bottom of the page.

Users

A screenshot of the 'Users' module interface. At the top, there is a dropdown menu showing 'Chris Olliver' with a downward arrow, highlighted with a red box. Below this is a table with five columns: 'Access', 'Access Type', 'Delete', and 'Edit'. The first column is unlabeled but contains the names of modules. The table data is as follows:

	Access	Access Type	Delete	Edit
Accounts	Enabled	Normal	All	All
Bugs	Enabled	Normal	All	All
Calls	Enabled	Normal	All	All

Viewing via Users Module

User profiles show which roles the user is related to and how the user's roles work together. When viewing a user profile, all role information can be found by navigating to the "Access" tab. For information about accessing the Users module, please refer to the [Users](#) documentation.

A screenshot of the 'User Profile' interface. At the top left is an 'Edit' button with a dropdown arrow. Below it are three tabs: 'User Profile', 'Advanced', and 'Access'. The 'Access' tab is selected and highlighted with a red box. Below the tabs, there is a section titled 'User Profile' with a sub-section 'Full Name: Chris Olliver'.

The access tab contains a chart showing all of the modules and actions available in Role Management. This chart is a compilation of all of the roles listed for the user in the Roles subpanel at the bottom of the page.

Chris Olliver

Edit ▾

User Profile Advanced Access

	Access	Access Type	Delete	Edit
Accounts	Enabled	Normal	All	All
Bugs	Enabled	Normal	All	All
Calls	Enabled	Normal	All	All

When viewing the chart, the most restrictive setting for the specific intersection will take precedence, and will represent the option for the user. Therefore, if the user has two roles assigned, one of which allows him or her to delete a record and another which does not, Sugar will enforce the option where the user cannot delete the record. The table shown in User Management cannot be edited. Instead, the role itself must be edited which will change the setting for any other users related to the role.

To view the role settings from User Management and make any necessary changes, simply click the role's name from the Roles subpanel, which will take you to the [role's detail view](#).

^ Roles

Select

Name	Description
Customer Support Administrator	Customer Support Administrator Role
Sales Administrator	Sales Administrator Role

Searching Roles

The Roles list view search function allows you to search for the name of the role to help you locate records easily and effectively. Once the search is performed, the relevant results will be displayed in the Roles [list view](#) below.

The buttons in the search panel have the following functions:

- **Search** : Click the Search button or press your Return/Enter key to perform the search
- **Clear** : Click the Clear button to clear all criteria from the searchable fields

To see all Role records, simply click "Clear" and then "Search" to perform a blank search with no name filter.

Roles

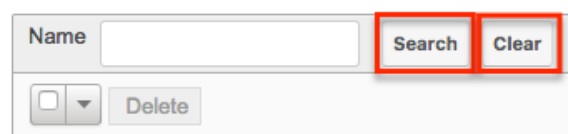

The image shows a search interface for Roles. It consists of a search panel with a text input field labeled 'Name'. To the right of the input field are two buttons: 'Search' and 'Clear'. Both buttons are highlighted with a red border. Below the search panel is a 'Delete' button with a small dropdown arrow to its left.

Please note that Sugar automatically appends the wildcard character (%) to the end of your search phrase. This allows the system to retrieve all records that start with the keyword entered in the search. If you would like to broaden the search, you can use the wildcard at the beginning of your text as well (e.g. %Administrator). This will pull up any record that has the word "administrator" in the name, regardless of how it starts or ends.

For more information on using the various search methods as well as how wildcards are used, please refer to the [Search documentation](#).

Roles List View

The Roles list view displays all roles that meet the current search criteria (if any). You can view the name and description of each role within the field columns. Click on the name of the role to access the [detail view](#) for the role and review the settings further.

Pagination

List view displays the current search results broken into pages that you can scroll through rather than displaying potentially thousands of rows at once. To the right just below the search panel you can see which records of the total results set are currently being displayed. The two single-arrow Next and Previous buttons can be used to scroll through the records page-by-page. The two double-arrow First Page and Last Page buttons allow you to skip to the beginning or the end of your current results.

By default, Sugar displays 20 records per list view page, but administrators can change the number of records displayed via the System menu in Admin. For more information on changing the number of displayed records, please refer to the [System](#) documentation in the Administration guide.

Roles

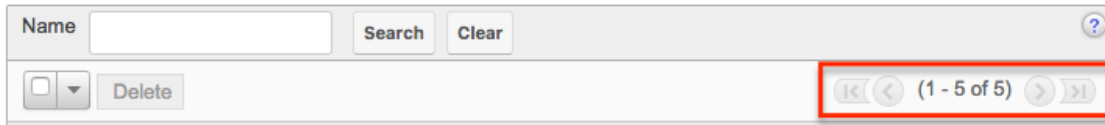

Checkbox Selection

Roles can be deleted in a mass-delete fashion via the list view by selecting all of the role records. To select individual role records on the Roles list view, mark the checkbox on the left of each row. To select or deselect multiple roles on the list view, use the options in the checkbox dropdown menu:

- **Select This Page** : Selects all records shown on the current page of results
- **Select All** : Selects all records in the current search results across all pages of results
- **Deselect All** : Deselects all records that are currently selected

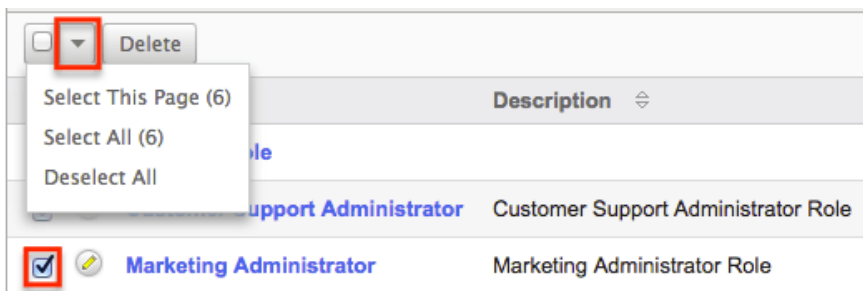

For more information on deleting roles, please refer to the [Mass Deleting via List View](#) section of this documentation.

Column Sorting

List view provides the ability to sort all of the current search results by a field column in either ascending or descending order. To sort by a field or switch the sort direction, click the column header for either "Name" or "Description". The list view may be sorted by only one column at a time.

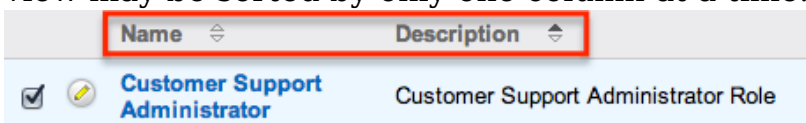

Roles Detail View

The Roles detail view displays thorough information about the role, as well as the ability to perform most actions related to role management. It comprises of a chart showing all modules in Sugar and actions that the user can have access to or be restricted from. The detail view also provides links that, when clicked, drill down into each module to make field-level permission changes. Finally, the detail view includes a Users subpanel where users can be related to the role and will, therefore, take on the role's properties.

Actions Menu

The Actions menu on the top left of each role's detail view allows you to perform various actions on the current record. Administrator users can change the action items to be displayed as separate buttons instead of a dropdown menu via Admin > System Settings. For more information on configuring the actions menu, please refer to the [System](#) documentation in the Administration guide.

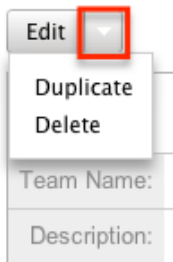

The options in the Actions menu allow you to perform the following operations:

Menu Item	Description
Edit	Edit the name and description of this role
Duplicate	Duplicate this role to create a new role
Delete	Delete this role

Role Chart

The Role Chart comprises of ten columns and a row for each module down the left-hand side. The columns each represent a type of action within Sugar, and the corresponding point between the columns and module roles defines the role's permissions. The role permissions can be updated from the detail view of each role. For an explanation of each action and how to update roles, please review the

[Setting Module-Level Permissions](#) section of this documentation.

	Access	Access Type	Delete	Edit	Export	Import	List	Mass Update	View
Accounts	Enabled	Admin & Developer	None	All	Not Set	Not Set	All	Not Set	All
Bugs	Enabled	Admin & Developer	All	All	Not Set	Not Set	All	Not Set	All

Field Permissions

To the left of the Role Chart is a list of hyperlinked Sugar module names:

Double click on a cell to change value.

[All](#)

[Accounts](#)

[Bugs](#)

[Calls](#)

[Cases](#)

[Contacts](#)

[Contracts](#)

[Documents](#)

[Emails](#)

	Access	Access Type	Delete
Accounts	Enabled	Admin & Developer	None
Bugs	Enabled	Admin & Developer	All
Calls	Not Set	Not Set	Not Set
Campaigns	Not Set	Not Set	Not Set
Cases	Enabled	Admin & Developer	Not Set

Click on a module name to access the Field Permissions view for the module. For an explanation of each action and how to update field-level permissions, please review the [Setting Field-Level Permissions](#) section of this page.

Field Permissions

Type [+]	Not Set	Annual Revenue [+]	Not Set	Assigned to [+]	Not Set	Billing Street [+]	Not Set
Campaign [+]	Not Set	Created By [+]	Not Set	Description [+]	Not Set	DUNS [+]	Not Set
Email [+]	Not Set	Email Address [+]	Not Set	Other Email [+]	Not Set	Email Opt Out [+]	Not Set

Users Subpanel

Beneath the Role Chart, the Users subpanel is available for the Administrator to relate one or more users to the current role. A user must be related to a role to take on the role's permission settings. One user can be related to multiple roles. If a user is related to multiple roles, the most restrictive option for each setting is respected.

To relate users to a role, use the following steps:

1. Navigate to the detail view of the role that you would like to edit.

-
2. At the bottom of the page, click "Select User" from the Users subpanel.



3. Use the pop-up search menu to search for and select the user(s) you would like to add to this role. You can either click on the user's name or, if selecting multiple users, click their corresponding checkbox and then click "Select".

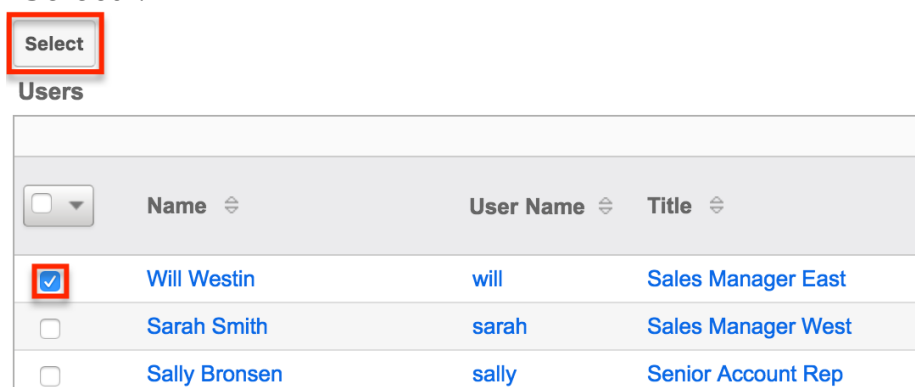

After selecting the user(s), the pop-up search box will close and the user(s) will now be displayed in the Users subpanel for the role to complete the relationship.

Editing Roles

Roles may be edited at any time to update or add information to the record or to edit the role restrictions. You can make changes to existing role records via the Roles detail view and edit view, depending on the change being made. Changes via the detail view are made directly on the role permission chart. Edit view is available within the Roles module and includes the Name and Detail fields.

Editing via Detail View

You can edit roles via the detail view by clicking the Edit button on the upper left of the page. Once the edit view layout is open, update either the Name or Description fields, then click "Save" to preserve the changes made.

Customer Support Administrator

Edit	
Name:	Customer Support Administrator
Description:	Customer Support Administrator Role

Edits to the settings on the role are also performed via the detail view. Below the Name and Description fields, is where you will find the role permission chart. This chart is made up of rows representing the different modules in Sugar, and columns representing each of the action types Sugar users can perform. Edits to this table are made by clicking the box at the intersection of a row and column, which produces a dropdown list of available options. For more information on module permission changes, please review the information in the [Setting Module-Level Permissions](#) section of this documentation.

Editing via List View

You can edit roles via the list view by clicking the Pencil icon to the left of each role's name. After clicking the pencil, the window will move to the edit view. Update the necessary fields, then click "Save" to preserve the changes. After saving from the edit view, you will be returned to the detail view for the record that you just updated. Because this method brings you to the edit view, only the Name and Description fields can be updated.

Name	Description
<input type="checkbox"/>  Customer Support Administrator	Customer Support Administrator Role

Editing via Users Module

The Users module allows you to see all of the roles related to a specific user in one place under the "Access" tab. The page will show a subpanel with a list of all of the roles related to the user. For more information about viewing the roles from the Users module, please review [Viewing via Users Module](#).

On the "Roles" subpanel, there is an option to edit the role. After clicking the "Edit" button, the window will move to the edit view. Update the necessary fields, then click "Save" to preserve the changes. After saving from the edit view, you will be returned to the detail view for the record that you just updated. Because this method brings you to the edit view, only the Name and Description fields can be updated.

Roles

Name	Description	
Customer Support Administrator	Customer Support Administrator Role	edit
Sales Administrator	Sales Administrator Role	edit

Deleting Roles

If a role record is invalid or is no longer being used in your organization's Sugar instance, it may be deleted from either the Roles detail view or list view. Deleting via the detail view allows you to delete a single record while the list view allows for mass deleting multiple records at once. Deleting role records will not delete the related user records and will only remove the relationship.

Deleting via Detail View

Use the following steps to delete a role via the detail view:

1. Navigate to the role record's detail view.
2. Select "Delete" from the Actions menu.

Products Role

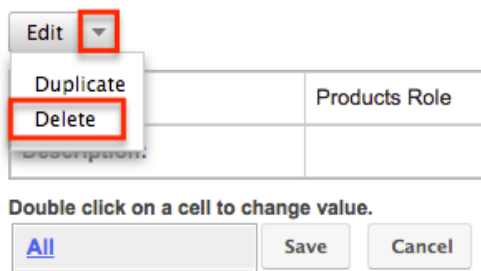

3. A pop-up message will display asking for confirmation. Click "Ok" to proceed.

Mass Deleting via List View

Use the following steps to delete one or more roles via the list view:

1. Navigate to Admin > Role Management.
2. Use the [search functionality](#) to find the Role records you wish to delete.
3. Select the desired role records individually or using the [checkbox](#)

[dropdown](#)'s options.

4. Choose "Delete" from the Actions menu.

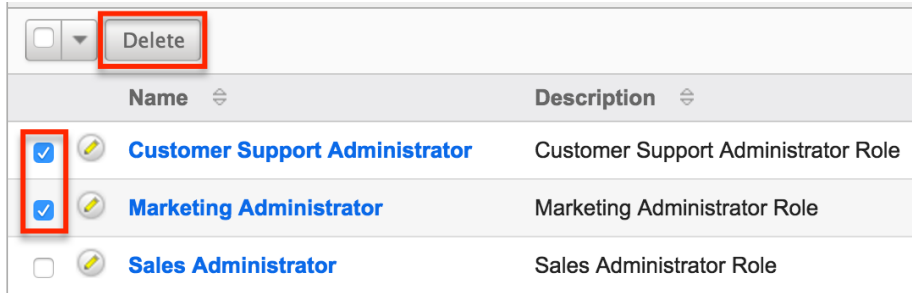

	Name	Description
<input checked="" type="checkbox"/>	Customer Support Administrator	Customer Support Administrator Role
<input checked="" type="checkbox"/>	Marketing Administrator	Marketing Administrator Role
<input type="checkbox"/>	Sales Administrator	Sales Administrator Role

5. A pop-up message will ask for confirmation. Click "Ok" to proceed.

Due to PHP memory limitations on the server, there may be occasions when the application times out while deleting a large number of role records. If you encounter an error when performing this action, we recommend selecting the records in smaller batches.

Last Modified: 2020-02-03 18:28:19

Password Management

Overview

Password Management is used to administer requirements and other policies about user passwords in Sugar. Sugar allows administrators to set up system-generated passwords versus manually created passwords for new users, failed login lockout attempts, and configure the email templates used to send password information to users. Password management is not used to change user's passwords, which can be done via their [User Profile](#).

Note: For instances that use SugarIdentity, an administrator will need to access [SugarIdentity](#) via the Cloud Settings console to configure [password requirements](#) as well as set up [LDAP](#) or [SAML](#) authentication.

Password Requirements

The Password Requirements panel lets you configure minimum and maximum lengths of passwords, as well as what characters are required in passwords. Filling in either of the first two fields, Minimum Length and Maximum Length, will force a requirement for your users to have passwords be more than or less than a given

amount of characters. Additionally, use any of the four checkboxes to force character requirements on users' passwords. This can force users to include upper case letters, lower case letters, numbers, or special characters in their passwords. Please note that the configured password requirements also apply to the Sugar Portal and must be respected when the portal user's password is created or changed.

Note: For instances that use SugarIdentity, [password requirements](#) are configured in SugarIdentity via the Cloud Settings console.

Password Requirements			
Minimum Length:	<input type="text" value="5"/>	Maximum Length:	<input type="text" value="10"/>
Must contain one upper case letter (A-Z):	<input checked="" type="checkbox"/>	Must contain one lower case letter (a-z):	<input checked="" type="checkbox"/>
Must contain one number (0-9):	<input checked="" type="checkbox"/>	Must contain one of the following special characters (-,!,@,#,\$,%^,&*,(,),_+, -, =, {, },):	<input type="checkbox"/>

Advanced Options

You can also specify words or other strings that are not allowed in a password, called Regex Requirements. The configurations for Regex Requirements are found in the Advanced Options section of the Password Requirements panel.

Note: For instances that use SugarIdentity, regex password controls are not available.

Must contain one number (0-9): <input checked="" type="checkbox"/>	Must contain one of the following special characters (-,!,@,#,\$,%^,&*,(,),_+, -, =, {, },): <input type="checkbox"/>
<input checked="" type="checkbox"/> Hide Advanced Options	
<input checked="" type="checkbox"/> Regex Requirement: <input type="text"/>	<input type="checkbox"/> Regex Description: <input type="text"/>

To set a Regex Requirement, type in code of characters that are not allowed. In the Regex Description field, write a message to users that will show when they try to edit their passwords, explaining what strings are not allowed. For more information on Regex usage, please review the Regular Expressions website at <http://www.regular-expressions.info/>.

Some examples of regular expressions in password rules are listed below:

Sample Expression	Password Rule
-------------------	---------------

Sugar	Password cannot contain the word Sugar.
([A-Za-z0-9])\1	Password cannot repeat a letter or number consecutively; for example, AA or 88.
([a-zA-Z]){4,}	Password cannot repeat any two consecutive letters; repeat characters or letters must be separated by a special character such as %.
[\t]	Password cannot contain spaces and tabs.
[@#\\$]	Password cannot contain @, #, or \$.

System-Generated Passwords

When enabled, the System-Generated Passwords feature will allow users to receive a randomly generated password via email. This functionality is utilized either when a new user is created or when an administrator activates the Reset Password button in the [user's profile](#).

Note: For instances that use SugarIdentity, the System-Generated Passwords feature is not available.

The two requirements to utilize system-generated passwords are:

- A user has a valid primary email address configured in their [User Profile](#).
- A system outbound email server (SMTP) is configured in [Email Settings](#).

For security reasons, when the System-Generated Passwords feature is enabled, you also have the option to set an expiration for the system-generated password. You can specify when the temporary password expires, either after a certain amount of days, months, or weeks, or after a specified number of logins. Simply click the radio button next to the expiration you would like to use and enter the login or length of time variable as necessary, or click "None" for the password to never expire. Once the temporary password expires, users will see a message upon login, informing them that the password has expired and to create a new password. The user will need to enter the temporary password along with the new password and confirm the password as well.

System-Generated Passwords
Enable System-Generated Passwords
Feature : 
Warning: An SMTP server for outbound emails is not configured in Email Settings. It must be configured in order to send passwords to users. A primary email address is required for each user in order to use this feature.
System-Generated Password Expiration
 None Password Expires in Password Expires upon logins

User Reset Password

The forgot password feature allows administrators to enable the Forgot Password link to display in the Sugar login window. If a user does not remember their password, they can click this option, enter their user name and their primary email address in Sugar, and a Reset Password link will be emailed, guiding them through the process to reset their forgotten password. For more information on how a user resets his or her password, please view the [Getting Started](#) documentation.

Note: For instances that use SugarIdentity, the "Forgot Password?" link is available on the Sugar login screen, but the feature cannot be configured.

The two requirements to utilize Forgot Password feature are:

- A user has a valid primary email address configured in their [User Profile](#).
- A system outbound email server (SMTP) is configured in [Email Settings](#).

CAPTCHA Validation

As an additional precaution, you can enable CAPTCHA validation to prevent automated programs from gaining unauthorized access to user accounts. When enabled, when a user attempts to use the Forgot Password feature, they will have to confirm a CAPTCHA, in addition to providing their user name and primary email address.

Note: For instances that use SugarIdentity, CAPTCHA validation is not available.

Use the following steps to enable CAPTCHA for the Forgot Password menu:

1. Create an account with reCAPTCHA from the reCAPTCHA website at <https://www.google.com/recaptcha>.
2. After creating an account, save your Public Key and Private Key, which will be entered into Sugar.
3. In Sugar, navigate to Password Management and the "User Reset Password" panel.
4. Click the checkbox to "Enable reCAPTCHA Validations".
5. Enter the Public Key and Private Key in the fields provided.

Honeypot Validations

Honeypots are a nonintrusive method of human form submission confirmation that is more effective than traditional CAPTCHA. Enabling the honeypot validation option will add an invisible input field to the Forgot Password form which only bots reading the HTML will be able to see. When the bots fill in the honeypot field, Sugar knows to disregard the submission since it was not created by a human, thus preventing unauthorized access to your Sugar instance.

Note: For Sugar instances that use SugarIdentity, Honeypot validation is not available.

Email Templates

Sugar comes standard with two password templates. One is for the [System-Generated Password](#) emails that are sent out, and the other is for the [Reset Password](#) email. The templates are editable through Password Management and new ones can also be created. To create a new version of either template, click the Create button on the specific line. To edit the existing template, click the Edit button on the specific line.

Note: For instances that use SugarIdentity, email templates cannot be created or edited.

Email Templates	
Email template containing system-generated password:	System-generated password email <input type="button" value="Create"/> <input type="button" value="Edit"/>
Email template containing system-generated link to reset password:	Forgot Password email <input type="button" value="Create"/> <input type="button" value="Edit"/>

Templates can also be viewed via the Emails module by navigating to the Email Templates list view. The templates are easily found as the Type is blank, whereas any other template will be either a Campaign, Email, or Workflow template. For more information on [Email Templates](#), please review the appropriate section of the application guide.

Note: If you choose to create your own templates to send passwords, copy the variables provided in the default template. The variables "\$contact_user_link_guid" from the "Forgot Password Email" and the "\$contact_user_user_hash" and "\$config_site_url" are not available from the variable dropdowns when creating the templates.

Name	Type	Description
<input type="checkbox"/> <input type="button" value="Delete"/> System-generated password email		This template is used when the System Administrator sends a new password to a user.
<input type="checkbox"/> <input type="button" value="Delete"/> Forgot Password email		This template is used to send a user a link to click to reset the user's account password.

User-Generated Password Expiration

Sugar can force users to create new passwords after a given period. Admins can configure this for either specific amounts of time in days, weeks, or months, or after a specific amount of logins. To configure a password expiration, select the radio button next to the expiration period you would like to use and enter the timeframe or amount of logins that the user will be allotted. Once the password expiration is reached, users will see a message upon login, informing them that their password has expired and to create a new password. The user will need to enter their current password along with their new password and confirm the password as well.

Note: For instances that use SugarIdentity, password expiration rules are configured in [SugarIdentity](#) via the Cloud Settings console.

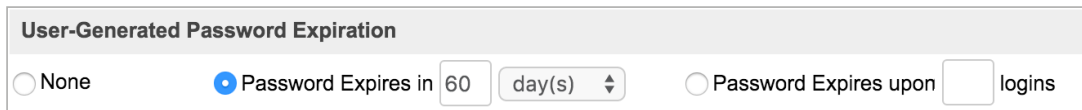

The screenshot shows the 'User-Generated Password Expiration' configuration panel. It features two radio buttons: 'None' (unselected) and 'Password Expires in' (selected). The 'Password Expires in' option is followed by a text input field containing '60' and a dropdown menu set to 'day(s)'. To the right, there is another radio button for 'Password Expires upon' followed by an empty text input field and the word 'logins'.

Login Lockout

To prevent against unauthorized logins, Sugar includes a configurable lockout function. This means that you will define a specific amount of unsuccessful attempts that a user name can be used to log in before the user name will not be able to log in. You also configure a given amount of time before the restriction is listed in either minutes, hours, or days. To configure Login Lockout, click the radio button next to "Lockout users after {blank} unsuccessful login attempts", fill in the maximum number of attempts allowed and define the timeframe.

Note: For instances that use SugarIdentity, login lockout rules are configured in [SugarIdentity](#) via the Cloud Settings console.

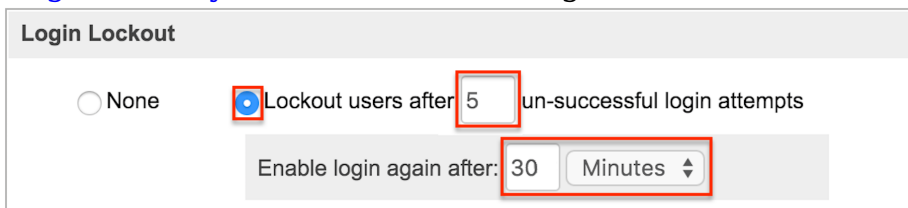

The screenshot shows the 'Login Lockout' configuration panel. It has two radio buttons: 'None' (unselected) and 'Lockout users after' (selected). The 'Lockout users after' option is followed by a text input field containing '5' and the text 'un-successful login attempts'. Below this, there is a section for 'Enable login again after:' with a text input field containing '30' and a dropdown menu set to 'Minutes'.

Note: When a user has been locked out, the user must wait until the given timeframe has passed. The only way to manually allow a user to log back in is by clicking the [Reset User Preferences](#) button in the user's profile.

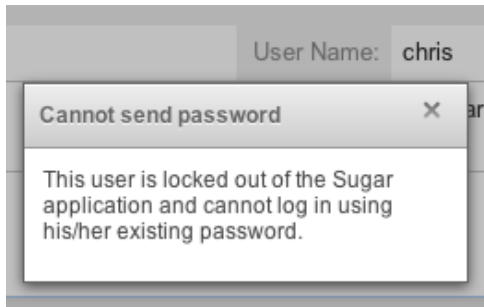

External Authentication

Sugar can respect external authentication protocols (i.e. LDAP and SAML) to give users a seamless login process via single sign-on (SSO) services. LDAP and SAML configuration options are located in the last two panels of the Password Management page. Click the checkbox next to the external authentication type that you would like to enable. Upon selection, the page's contents will refresh and the chosen protocol will supersede any other Password Management settings.

Note: For instances that use SugarIdentity, [LDAP](#) and [SAML](#) authentication are configured in SugarIdentity via the Cloud Settings console.

Note: If a user logs out of their single sign-on account from outside of Sugar, they will continue to be logged into Sugar.



The following sections explain [LDAP](#) and [SAML](#) options in more detail.

Note: [Team Management](#) and [Role Management](#) are still taken into account when External Authentication is active.

LDAP

Sugar can be configured to accept Lightweight Directory Access Protocol (LDAP) authentication if your organization has implemented LDAP or Active Directory authentication. When users in your system attempt to log into Sugar, the application will authenticate their credentials against your LDAP directory or

Active Directory. If authentication is successful, the user is granted access to Sugar. If the authentication is unsuccessful, Sugar will then attempt to verify the provided credentials against its own database of valid user names and passwords. Please note that for instances that use SugarIdentity, [LDAP](#) is configured in SugarIdentity via the Cloud Settings console.

To configure LDAP, navigate to Admin > Password Management, and enable the "Enable LDAP Authentication" checkbox in the LDAP Support panel. Sugar will then display some [additional fields](#) where you can enter information specific to your LDAP or Active Directory account.

Once you have completed the form, you will then need to enable LDAP for users by navigating to Admin > User Management, selecting the desired user, then clicking the Advanced tab in their user profile. Enable the "LDAP Authentication Only" checkbox then click "Save". Sugar will then synchronize the user's Active Directory user name and present the password on the LDAP port. When the user next logs into Sugar, they will enter their Active Directory username and password.

LDAP Fields

Fill in the appropriate options in the following fields, and then click "Save" to commit the changes. The following are suggested values for each field, but these may vary depending on your LDAP configuration.

Field	Suggested Values	Description
Authentication	<p>Enter "username@MYSERVER.MYDOMAIN.com" or "domain\\userfirstname.userlastname" for the User Name, and the corresponding Password.</p> <p>Note: The latter username format requires double backslashes after the</p>	<p>Check this box to enable the User Name and Password fields.</p> <p>Note: You must add a service account user (read-only access) to your Active Directory to authenticate via Sugar.</p>

	domain. Sugar will automatically remove one backslash upon Save.	
Auto Create Users	Typically, this box remains disabled.	Select this checkbox to create the username in the Sugar database if it does not already exist. Note: When enabled, a Sugar user is created for every LDAP user logging into the application. This will occupy an active Sugar license for each created user.
Bind Attribute	For Active Directory, enter userPrincipalName	A case-sensitive value
Enable LDAP Authentication		Uncheck this box if you would like to disable LDAP in your instance.
Encryption Key		If you are using LDAP with SOAP, enter the encryption key to encrypt user passwords in the Sugar Plug-in for Microsoft Outlook . Note: The "php_mcrypt" extension must be enabled in the php.ini file.
Group Membership	<p>Group DN : Enter the group DN name</p> <ul style="list-style-type: none"> • ou=groups • dc=example • dc=com <p>Group Name : Enter the group name</p> <ul style="list-style-type: none"> • cn=sugarcrm <p>User Attribute : A unique identifier used to check if</p>	Select this checkbox if you wish to specify that the user is a member of a specific group.

	<p>the user is a member of the group</p> <ul style="list-style-type: none"> • uid <p>Group Attribute : The attribute of the group that will be used to filter against the User Attribute</p> <ul style="list-style-type: none"> • MemberUid 	
Login Attribute	For Active Directory, enter sAMAccountName	A case-sensitive value
Port Number	389	<p>Enter the port number. 389 is the default port.</p> <p>If you are using a secure TLS connection, the default is 636.</p>
Server	MYSERVER.MYDOMAIN.com	Enter the FQDN of your Active Directory Server which should be your Domain Controller.
User DN	ou=people, dc=example, dc=com	Enter the user DN name.
User Filter	is_user_id=1	Enter any additional parameters to apply when authenticating users.

SAML

Sugar can be configured to accept Security Assertion Markup Language (SAML) for single sign-on if it is implemented at your organization. When users in your system attempt to log into Sugar, the application will authenticate them against SAML. If authentication is successful, the user is granted access to Sugar. If the authentication is unsuccessful, Sugar will then attempt to verify the provided credentials against its own database of valid user names and passwords. Sugar supports the use of SAML version 2.0.

Note: For instances that use SugarIdentity, [SAML](#) is configured in SugarIdentity

via the Cloud Settings console.

Use the following steps to configure SAML authentication:

1. Navigate to Admin > Password Management and click the "Enable SAML Authentication" checkbox in the SAML Authentication panel.
2. Enter appropriate values in the [fields](#) on the SAML Authentication page. If you have downloaded a metadata file from the identity provider (e.g. Okta, Google, ADFS), then skip to step 3.

Save Cancel **Export Metadata File** **Import IdP Metadata File**

SAML Authentication

Enable SAML Authentication

Login URL

SLO URL

Entity ID

SugarCRM Entity ID

X509 Certificate

Auto-create user

Load login screen in same window to avoid pop-up blocking

Request Signing Private Key No file chosen

Request Signing Certificate No file chosen

Request Signing method

Sign AuthN Request

Sign Logout Request

Sign Logout Response

3. If you have obtained a metadata file from the identity provider (e.g. Okta, Google, ADFS), then you can import the file by clicking the "Import IdP Metadata File" button. Locate the metadata file you saved then click "Open". Certain fields (e.g. Login URL, SLO URL, Entity ID, X509 Certificate) on the page will be auto-populated with data from the file. Optionally, complete any other desired [fields](#) on the configuration page based on your needs.

Note: If you are using Okta with single logout enabled, then you will need to complete the "Sign Logout Request", Request Signing Private Key", and "Request Signing Certificate" fields in order to digitally sign the logout request.

4. Once the necessary fields have been completed, click "Save" to preserve the settings.

When using ADFS, you will need to export an XML metadata file containing the SAML settings which you will need in order to configure a new trust relationship between Sugar and ADFS to allow communication between the two services. Simply click the "Export Metadata File" button to download the necessary file. Please note that you will only be able to export a file if the required fields have been completed and saved. Once you have the metadata file, follow the steps in the [Configuring SSO With Active Directory's ADFS in Sugar 8.0 and Higher](#) article to configure a new ADFS trust relationship.

SAML Fields

The available fields to configure on the SAML Authentication page are as follows:

Field	Description
Enable SAML Authentication	Uncheck this box if you would like to disable SAML Authentication in your instance.
Login URL	Enter the SAML URL for authentication. Note: This is the path to the SAML server to which you are authenticating.
SLO URL	Enter the single logout endpoint to which Sugar will send logout requests. When Sugar sends a logout request to the identity provider (e.g. Okta), it will extend that request and terminate active sessions for all other service providers that are sharing the session established via SAML. Note: Single logout requests can be initiated from either the identity provider or Sugar.
Entity ID	Enter a valid URI for the IdP (identity provider) entity. Note: Sugar will only accept SAML assertions from this ID.
SugarCRM Entity ID	Enter a valid URI for the service

	provider entity.
X509 Certificate	Enter the SAML X509 certificate public key.
Auto-create user	Check this box to automatically create a new username in the Sugar database if it does not already exist. When enabled, a new Sugar user is created for every SAML user logging into the application. Note: This will occupy an active Sugar license for each created user.
Load login screen in same window to avoid pop-up blocking	Enable this option to load the SAML login screen in the current window to prevent pop-up blockers from preventing single sign-on.
Request Signing Private Key	Upload the PEM file containing the private key to be used to sign the AuthN and Logout requests. Note: The private key must be uploaded in order to sign the logout request, logout response, and/or AuthN request.
Request Signing Certificate	Upload the CRT file containing the X.509 certificate to be used to sign the AuthN and Logout requests. Note: The certificate should match the uploaded private key.
Request Signing method	Select the digital signing method for the logout request, logout response, and/or AuthN request. The recommended options are either "RSA-SHA256" or "RSA-SHA512".
Sign AuthN Request	Check the box to sign the AuthN request using the private key and certificate. Note: The "Request Signing Private Key", "Request Signing Certificate", and "Request Signing method" fields must be completed in order to sign the AuthN request.
Sign Logout Request	Check this box to sign the logout request using the private key and certificate. Note: The "Request Signing Private Key", "Request Signing Certificate", and "Request Signing method" fields must

	be completed in order to sign the logout request.
Sign Logout Response	<p>Check this box to sign the logout response using the private key and certificate.</p> <p>Note: The "Request Signing Private Key", "Request Signing Certificate", and "Request Signing method" fields must be completed in order to sign the logout response.</p>

If you are using OneLogin, please ensure that only the email address user field is mapped to Sugar's email address field in OneLogin's parameters configuration. Mapping to other fields such as user name is not supported and may prevent authentication.

Note: You must disable the [Forgot Password](#) option if you are using SAML authentication.

Setting User Passwords

Administrators have the option to manually set or reset user's passwords as need be. Setting a regular user's password is done simply through the Users module via Admin > User Management. This method will vary depending on the [System-Generated Passwords](#) option. For more information on changing a user's password from the Users module, please review the [Resetting User Passwords](#) section of the Users documentation.

Note: For instances that use SugarIdentity, administrators will not be able to manually change or reset a user's password via the user's profile. Users can instead click the "Forgot Password?" link on the Sugar login screen to reset their passwords.

Last Modified: 2019-12-05 15:47:53

User Management

Overview

The User Management module provides administrators access to create, edit, activate, and deactivate the profiles of all the users in their Sugar instance. This module and underlying settings control each individual's login credentials as well as some personalized settings. During the installation process, Sugar creates one system administrator by default. The system administrator can log in and create additional users, in a variety of capacities, to be able to access Sugar and utilize all of the other CRM functionality. In combination with the role and team security, administrators can fully establish a profile for each user in Sugar.

Note: For instances that use SugarIdentity, the administrator will need to access [SugarIdentity](#) via the Cloud Settings console to create and manage user records.

Licensed User Limits

If an instance has more active users of a particular license type than is allowed by its Sugar license, regular users will not be able to log in. Admin users will be able to log in but will be redirected to the Users module. Once they have [deactivated](#) enough users, reduced the users assigned to over-limit license types, or purchased additional seats, regular users will be able to log in again. Users with an inactive status, Group users, and Portal API users do not count toward these limits. [User types](#) and [license types](#) are described in more detail below. For more information on how Sugar's licensed user limits work, refer to the [Understanding User Types, License Types, and Sugar Licenses](#) article. SugarCloud customers can monitor the number of active users counting against their license via the [SugarCloud Insights](#) page.

User Types

There are four types of users in Sugar: Regular User, System Administrator, Group User, and Portal API User. Each user type has different functions in Sugar which will vary for each instance. Depending on an organization's use of Sugar, not all of these user types will be necessary. Only regular users and system administrators in an Active status count towards [licensed user limits](#). The purpose of each user type is explained in the following sections.

Regular User

A regular user is the most common of the user types. A majority of employees of an organization will be regular users. This user can access most Sugar modules and perform most standard functions by default. Regular users are subject to be

restricted in their abilities and what records they can access by an administrator using the [Teams](#) and [Roles](#) functionalities in Sugar.

Regular Users will appear in the [Employees](#) module. To create a Regular User, please review the [Regular and Admin Users](#) section of this documentation.

System Administrator

System Administrator users, or "admins," have all of the abilities and functionality of a regular user, but also have administrative privileges as well. Admins can perform functions such as creating and editing users, editing system-wide settings, and have access to diagnostic and troubleshooting tools. In addition, admins can access all modules and records and are not subject to team or role restrictions. All instances of Sugar require at least one administrator, but it is also recommended to have more than one in case the original admin is unavailable or is no longer with the company.

System Administrators will appear in the [Employees](#) module. To create a System Administrator, please review the [Regular and Admin Users](#) section of this documentation.

Note: All administrators where the user status is active count as a licensed user.

Group User

A Group User is a bucket that is used for assigning records to a non-specific user (e.g. Sales, Support) in the organization. Unlike a Regular or System Administrator user, a Group user does not have access to log in to Sugar. Due to this, they do not have the same profile settings available, including the option to set a password. Since Group users cannot log in to Sugar, they do not count against an organization's license count.

Examples of uses for a Group user would be to assign all new leads to a group user named "Sales" or assign all newly-created support cases to "Support" before they are delegated to specific users (e.g., John Smith) in the organization.

Please note that Group users will not appear in the [Employees](#) module. For more information on how to create a Group user, please review the [Group Users](#) section of this documentation.

Portal API User

A Portal API User is similar to a Group User except that it is created specifically to communicate with the Sugar server using the Sugar Portal SOAP API functionality. It is intended only for use with Sugar Portal and is enabled when the Sugar Portal is enabled via Admin > Sugar Portal. It must remain enabled in order for portal users to authenticate. Using legacy Sugar Portal (an external application) also requires the enablement of this user. This user can only be used to authenticate contact credentials against SOAP V1 portal API methods in Sugar Sell, Serve, Enterprise, and Ultimate. To create a Portal API user, please review the [Portal API Users](#) section of this documentation.

Portal API Users will not appear in the [Employees](#) module and are not counted in the user license agreement. More information about the Sugar Portal can be found in the Sugar Portal documentation. Sugar's API documentation can be found in the [Web Services](#) section of the Developer Guide.

Note: The Portal API user is not intended to be a free API user for external integrations and has very limited functionality through the SOAP API.

License Types

For two of the user types, regular users and system administrators, an additional field appears on user records called "License Type". This field determines what functionality the user may access. The options which appear in this field are determined by the product(s) which an organization has purchased from SugarCRM. When an organization has purchased more than one product, such as Sugar Sell and Sugar Serve, both will appear as options in the License Type field. Each user must have at least one license type selected, and selecting multiple products enables the user to access the combined functionality of all selected options. Select multiple options by clicking while holding the control or command key. [Licensed user limits](#) are calculated per each license type, and an active user assigned to multiple license types will be counted against each.

The following table describes what functionality is available for each license type in Sugar 9.3.x. In addition, some stock reports are only available to certain license types as described in the [Stock Reports](#) page.

Functionality (Sugar 9.3.x)	Sell	Serve	Ultimate	Enterprise	Professional
Accounts ¹ Activity Streams Calendar	<input type="checkbox"/>	<input type="checkbox"/>	<input type="checkbox"/>	<input type="checkbox"/>	<input type="checkbox"/>

Calls Contacts Data Privacy Documents Emails Employees Knowledge Base Meetings Notes Notifications Product Catalog¹ Reports Tags Tasks					
Advanced Reports Holidays Sugar Portal² SugarBPM Tile View	☐	☐	☐	☐	
Business Centers Comment Log Dashlet Interactions Dashlet Record View Dashlet	☐	☐			
Sales SugarBPM Templates Renewals	☐				

Console Active Subscriptions Dashlet					
Change Timers Customer Service SugarBPM Templates Service Console		☐			
Bugs Cases² Releases Cases Summary Dashlet		☐	☐	☐	☐
Campaigns Contracts Forecasts Leads Opportunities ¹ Quotes Quoted Line Items ¹ Shipping Providers Target Lists Targets Tax Rates Web-to-Lead	☐		☐	☐	☐

Forms Top 10 Sales Dashlet Forecast Bar Chart Dashlet Sales Pipeline Chart Dashlet In Forecast Dashlet Opportunity Metrics Dashlet Product Catalog Dashlet Product Catalog Quick Picks Dashlet					
Revenue Line Items ¹	<input type="checkbox"/>		<input type="checkbox"/>	<input type="checkbox"/>	
Legacy Workflow Projects			<input type="checkbox"/>	<input type="checkbox"/>	<input type="checkbox"/>

¹ This module includes [enhanced functionality for Sugar Sell](#) license types.

² This module includes [enhanced functionality for Sugar Serve](#) license types.

Enhanced Module Functionality for Sugar Sell License Types

The following functionality is included on top of base module functionality for users

with a Sugar Sell license type in Sugar 9.3.x.

- **Pipeline renewal automation** : When you close an opportunity containing a renewable service, Sugar Sell will automatically create a renewal opportunity with an expected close date that aligns with the end date of the renewable service. Modules that are enhanced by pipeline renewal automation are Accounts, Opportunities, Revenue Line Items, Quoted Line Items, and Product Catalog.

Enhanced Module Functionality for Sugar Serve License Types

The following functionality is included on top of base module functionality for users with a Sugar Serve license type in Sugar 9.3.x.

- [Sugar Portal case deflection](#): Knowledge base article search from Sugar Portal's Home page allows portal users better access to self-service issue resolution prior to creating cases.
- [Sugar Portal case and knowledge base dashlets](#) : The All Open Cases, Recently Resolved Cases, and Knowledge Base Categories & Published Articles dashlets allow portal users to view their company's current and recent cases and search for knowledge base articles.
- [Case SLA and resolution trends](#) : Several fields are included on cases to track trends in first response SLAs and case resolution time, using both calendar hours and business hours.

User Fields

The Users module contains a number of stock fields, which are included out-of-the-box with Sugar. The below definitions are suggested meanings for the fields, but many of the fields can be leveraged differently to best meet your organization's needs. System Administrators have the ability to alter, remove, or add fields in the User Profile tab via Admin > Studio, minus a few noted exceptions. For more information on adding or modifying fields, please refer to the [Studio](#) documentation.

For instances that use SugarIdentity, the following user fields are read-only and can only be edited in [SugarIdentity](#) via the Cloud Settings console:

- Username
- Status
- User Type

- First Name
- Last Name
- Title
- Department
- Work Phone
- Address Street
- Address City
- Address State
- Address Postal Code
- Address Country
- Primary Email Address

The User Profile tab contains the contact information for the user and other important user-specific settings. The User fields are as follows:

Field	Description
Address City	The city of the user's address
Address Country	The country of the user's address
Address Postal Code	The postal code of the user's address
Address State	The state of the user's address
Address Street	The street name and number of the user's address
Avatar	Upload an image to this field to represent the user that will be shown on the Activity Stream and next to the user's name on the navigation bar
Business Center Name	The business center this user belongs to Note: This field is only available to Sugar Serve and Sugar Sell users.
Department	The department where this user works
Description	A description or other information about this user
Display Employee Record	Check this box if the user should have an employee record show in the Employees module
Email Address	The user's email addresses, where a primary address is selected to receive email notifications and if this should be a reply to address when using Sugar's outbound email (SMTP) functionality Note: This field is not editable in Studio

Email Client	<p>When clicking on an email address in Sugar, this will determine if Sugar's email composer will open or if the user's primary email program on this computer (e.g. Microsoft Outlook, Apple Mail, etc.) will open</p> <p>Note: This field is not editable in Studio</p>
Employee Status	<p>The user's employment status in the organization (Active, Terminated, or Leave of Absence)</p> <p>Note: The Employee Status and Status fields are managed separately, so consider choosing a new employee status when the Status field changes.</p>
Fax	The user's fax number
First Name	The user's first name
Home Phone	The user's home phone number
IM Name	The user's instant message screen name
IM Type	The user's instant message service type
Last Name	The user's last name
License Type	<p>Determines what Sugar functionality the user may access</p> <p>Note: For more information, refer to the License Types section above.</p>
Mobile	The user's mobile phone number
Other Phone	An additional phone number for the user
Reports to	<p>The user's manager. The user that this user reports to will become an implicit member of this user's Teams, and this user will also affect their manager's forecasting</p> <p>Note: This field is not editable in Studio</p>
SMTP Password	If an outgoing email server is defined in Admin > System Email Settings , the user's SMTP password can be input here to send mail through Sugar

	<p>Note: This field is not editable in Studio</p>
SMTP Username	<p>If an outgoing email server is defined in Admin > System Email Settings, the user's SMTP user name can be input here to send mail through Sugar</p> <p>Note: This field is not editable in Studio</p>
Status	<p>Making a user inactive will make it so this user cannot log in to Sugar. This will also remove the user from taking a license seat, without having to delete the user. When making a user inactive, the admin is prompted to use the Reassign Records function.</p> <p>Note: The Employee Status and Status fields are managed separately, so consider choosing a new employee status when the Status field changes.</p>
Title	The user's job title
User Name	<p>The user name will be what the user logs in to Sugar with on the login page. It will also show for other users when they view fields such as "Assigned to" and "Created By". This is the name that will define the specific user in Sugar and should be unique for every user.</p> <p>Note: Spaces may not be included in user names.</p>
User Type	<p>Specifies what type of user this is which, a system administrator, regular user, etc as described in the User Types section above</p> <p>Note: This field is not editable in Studio</p>
Work Phone	The user's work phone number

The Advanced tab in the user's profile includes settings to configure how Sugar will function for that specific user. The fields in the Advanced tab cannot be edited in Studio.

Field	Description
1000s Separator	Select a character to use as a 1000's separator, with an example showing in the "Example" box
Create Revenue Line Items in Preferred Currency	Mark the checkbox to use your preferred currency when creating revenue line items based on a product catalog item, rather than the default behavior of using the product catalog item's currency
Data Font Size	The default font size of the PDF body when generated by this user
Date Format	How date fields will appear for the user, with the ability to control month, day, and year formatting
Decimal Symbol	Select a character to use as a decimal symbol, with an example showing in the "Example" box
Default Teams	<p>A default team defines the team set when this user creates a record. Whenever this user creates a record, the team is set as the user's default team, similar to how the "Assigned To" field is set to be the created user.</p> <p>Note: Users can be assigned any number of default teams</p>
Export Delimiter	Character or characters used to delimit exported data by this user
First Day of Week	Which day of the week will show as the first day when the user views the Sugar calendar
Font for Footer	Select a font for the footer in PDF documents when generated by this user
Font for Header and Body	Select a font for the header and body of PDF documents when generated by this user
iCal integration URL	URL in which someone can subscribe to the user's Sugar calendar within iCal or other programs that support iCal integrations

Import/Export Character Set	The default character set used for imports, exports, and vCard generation for this user
Main Font Size	The default font size in the PDF header when generated by this user
Name Display Format	How concatenated name fields will appear for the user, with the ability to control first name, last name, and salutation formatting
Notify on Assignment	<p>When this box is checked, the user will receive an email notification when a record is assigned to them by another user</p> <p>Note: A system outbound mail account must be enabled in Admin > System Email Settings</p>
Preferred Currency	Select the user's default currency to be used when creating new records. Additional currencies can be defined in Admin > Currencies .
Publish at my Location	Used to share free/busy information between Sugar and Microsoft Outlook calendars
Publish Key	Alphanumeric code entered by the user to uniquely identify his or her calendar and populate the iCal integration URL, Publish at my location site, and Search Location
Reminders	<p>This field sets the default reminder settings for calls and meetings created by this user so that when the user creates a call or meeting, the reminder settings will be pre-populated to the configuration defined in this field.</p> <p>Popup: Users that are invited to a call or meeting created by this user to receive a browser popup notification for the call or meeting at a given time interval before the activity.</p> <p>Email all invitees: Invitees invited to a</p>

	call or meeting created by this user to receive an email notification for the call or meeting at a given time interval before the activity.
Search Location	Used to share free/busy information between Sugar and Microsoft Outlook calendars
Select Modules for Navigation Bar	The order of the module navigation bar is defined by the order in the Display Modules column and modules listed in the Hide Modules column will not appear in the bar
Show Full Names	When this box is checked, the user will see users' full names ("John Smith") instead of user names ("jsmith") when using Sugar
Show Preferred Currency	Mark the checkbox to convert the base currency to user-preferred currency in list views and record views Note: User-preferred currency is not used in the Quotes record view or for quoted line items.
System Significant Digits	Define how many digits will appear after the decimal point when the user views a currency field, with an example showing in the "Example" box
Time Format	How time fields will appear for the user, with the ability to control hour, minute, and 12 versus 24-hour clock formatting
Time Zone	Select the local time zone for this user based on geographical location Note: This Time Zone setting only applies to modules using the Legacy user interface. Modules using the Sidecar user interface will utilize the browser's time zone.
User Wizard Prompt	Mark the checkbox to have users go through the New User Wizard upon their first login

Note: The Quotes and Revenue Line Items modules are not available for Sugar

Serve users. For more information on license types and the functionality available for each type, refer to the [License Types](#) section.

Understanding the Reports To Field

The Reports To field on the User record is used by various parts of Sugar to determine who a user's manager (i.e. supervisor) is. Some examples of how Sugar uses this relationship are described below:

- **Workflow Management** : Alerts and actions in Sugar's Workflows module allow you to send an alert to or assign a record to a user's manager. For example, you may wish to notify a user's manager when that user creates a new high-priority case. Refer to the [Workflow Management](#) documentation for more information.
- **SugarBPM** : Users' managers can be used in activity assignments, email recipients, and evaluations when designing a process definition. For example, you may wish to assign an approval activity to the manager of the owner of a quote before the quote is ready to be sent to the customer. Refer to the [Process Definitions](#) documentation for more information.
- **Teams** : Managers are an implicit member of all of their reportees' teams, which gives them access to all of their reportees' records. Refer to the [Team Management](#) documentation for more details on implicit and explicit team membership.
- **Organization Chart Dashlet** : This dashlet visually outlines the hierarchy of Sugar users under the current user according to the Reports To field. The dashlet includes reportees that are two or more levels below them.

Note: Only administrators can edit the Reports To field.

Users Module Tab

Administrators can access the Users module tab via Admin > User Management. Click the triangle in the Users module tab to open the Actions menu and Recently Viewed menu. You can also click the Users tab to access the Users list view. The Actions menu allows you to perform important actions within the module. The Recently Viewed menu displays the list of users you last viewed in the module. For more information on records last viewed, please refer to the [Viewing Via Recently Viewed](#) section of this page.

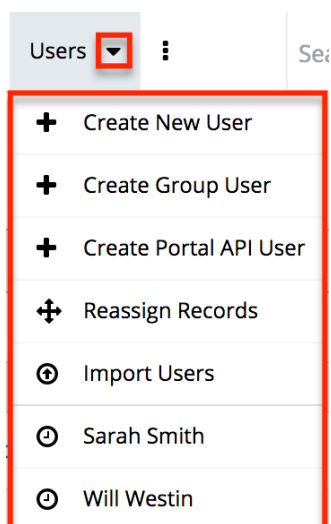

The options in the Actions menu allow you to perform the following types of action:

Option	Description
Create New User	Opens the edit view layout to create a new user Note: For instances that use SugarIdentity, the Cloud Settings Console opens in a new browser tab to create a new user.
Create Group User	Opens the edit view layout to create a new Group User
Create Portal API User	Opens the edit view layout to create a new Portal API User
Reassign Records	Opens the Reassign Records tool
Import Users	Opens the import wizard to create or update users using external data Note: The import option is not available for Sugar instances that are SugarIdentity-enabled. Administrators can access SugarIdentity via the Cloud Settings console to import a list of new users using a .csv file.

Creating Users

There are various methods for creating new users in Sugar. These are via the Users module, duplication, or import. Creating users is an imperative function in Sugar as it allows for other members of your organization to log in and work in Sugar. Please note that you will not be able to add more users of a particular license type than is allowed by your Sugar license. For more information on how Sugar's licensed user limits work, refer to the [Understanding User Types, License Types, and Sugar Licenses](#) article.

Note: For instances that use SugarIdentity, an administrator will need to access SugarIdentity via the Cloud Settings console in order to [create](#) new users.

Creating Via Module Tab

The most common method for creating users in Sugar is via the Users module. The edit view layout opens when creating the user directly from the Users menu and includes all of the relevant fields to create a new user. The fields and options on the Create page will vary depending on the [type of user](#) you are creating.

Regular and Admin Users

Regular and Admin users are the most common users that will be created in a Sugar instance and contain the most detail and fields compared to the other [user types](#). For more information about the use of Regular and Admin users, please review the [Regular User](#) and [System Administrator](#) sections of this documentation.

Note: For instances that use SugarIdentity, administrators will need to [create](#) SugarIdentity user records via the Cloud Settings console. In addition, administrators will not be able to manually change or reset the user's password via the user's profile. Users can instead click the Forgot Password link on the Sugar login screen to reset their passwords.

Use the following steps to create a new user:

1. Navigate to Admin > User Management.
2. Click the triangle in the Users module tab to open the Actions menu and select "Create New User".

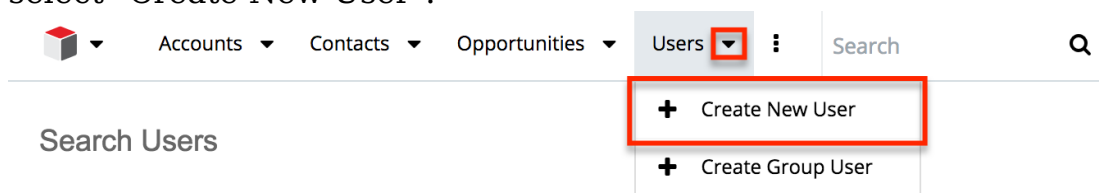

3. Enter appropriate values for the [fields](#) in the edit view layout. All required fields are marked with a red asterisk and must be completed prior to

saving.

- Enter the following information under the User Profile tab:
 - In "User Profile" enter a user name for this user which will define the specific user in Sugar and should be unique for every user. Sugar will default the user to being Active and a Regular User, which can be updated if the user is going to be an administrator.
 - In "Employee Information", contact information and other specific information about the user can be added. This will include phone numbers, contact address, the user's department and job title, and any description information.
 - In "Email Settings" the user's email address or addresses can be added. The email addresses can also be marked as "Primary", meaning that this will be the first email address that shows for the user, and "Reply-to", where automatic notifications from Sugar will be sent. In this section, the user's outbound email client will be selected to default to Sugar or an external program, such as Microsoft Outlook. If a mail server is configured in Admin > [System Email Settings](#), additional options will display here for SMTP Username and SMTP Password.

Email Settings	
Email Address: *	
<input data-bbox="778 1126 810 1171" type="button" value="+"/>	Primary Reply-to
<input data-bbox="783 1189 1139 1234" type="text" value="test@example.com"/>	<input checked="" type="radio"/> <input type="radio"/>
<input data-bbox="783 1256 1139 1301" type="text" value="example@test.com"/>	<input type="radio"/> <input checked="" type="radio"/>
	<input data-bbox="1171 1256 1203 1301" type="button" value="-"/>
Email Client: <input data-bbox="651 1346 683 1391" type="button" value="i"/>	<input data-bbox="762 1346 1038 1391" type="text" value="Sugar Email Client"/>

- The Advanced tab includes preference-type settings (User Settings, Layout Options, Locale Settings, PDF Settings, Calendar Options) for the user. These are all specific to the user's account and will not affect system-wide settings or other users. Options such as assignment notifications, date and time formats, time zone, preferred currency, etc. are available to configure under this tab.
4. If the system-generated password feature is not enabled in [Password Management](#), a Password tab will appear to the right of the User Profile tab. The administrator can manually enter a password for the user under this tab and provide it to the user. Please note that the password requirements listed on the right will be checked off as the new password meets the required conditions.

Note: If the system-generated password feature is enabled, this tab will not be available. Instead, a system-generated password will be sent to the user upon completion of the creation process.

5. After entering the necessary information click the Save button.

Create

Upon saving, an email will be sent to the user with the user's system-generated password (if applicable) and a corresponding Employee record will be created for the user. Once the user is created, the administrator can assign [Teams](#) and [Roles](#) to the user via the [Access](#) tab.

Group Users

A Group user cannot log in to Sugar, but new and existing records can be assigned to the Group user. The Create page for the Group user consists of the User Name, Status, Name, User Type, and Email Address fields. For more information on how to use Group users in Sugar, please review the [Group User](#) section of this documentation.

Use the following steps to create a Group user:

1. Click the triangle in the Users module tab to open the Actions menu and select "Create Group User".

2. Enter a name and user name (e.g. Support) for this user.
3. In the Email Settings section, enter an email address or addresses for the Group user. The group user's primary email address will be marked as "Primary" and you can also mark "Reply-to" if any automatic notifications from Sugar will be sent to this address.
 - **Note:** If your organization has a group inbox or alias for a team represented by the group inbox, the email address can be added here for all notifications to be sent to the entire team.
4. Click "Save" to create the user.

Create

The screenshot shows the 'Create User' form in Sugar CRM. At the top, there are three buttons: 'Save' (highlighted with a red box), 'Cancel', and 'Reset User Preferences'. A legend indicates that an asterisk (*) denotes a required field. The form is divided into two main sections: 'User Profile' and 'Email Settings'.
 In the 'User Profile' section, there are two columns of fields. The left column contains 'User Name: *' with the value 'Support' and 'Status: *' with a dropdown menu set to 'Active'. The right column contains 'Name: *' with the value 'Support' and 'User Type: *' with a dropdown menu set to 'Group User'. A descriptive note for 'Group User' states: 'Use for assigning items to a group (example: for Inbound Email). This type cannot login through the Sugar web interface.'
 The 'Email Settings' section features an 'Email Address:' label and a list of email addresses. One address, 'support@example.com', is shown with a '+' button to its left and a '-' button to its right. To the right of the address list are two columns: 'Primary' and 'Reply-to', each with a radio button. The 'Primary' radio button is selected.

Portal API Users

A Portal API user cannot log into Sugar via the web interface, but the name and user name will appear for other users as they view records assigned to the group user or assign records to this user. The Portal API user creation screen only contains five fields. For more information on the use of the Portal API user, please review the [Portal API User](#) section of this documentation.

Use the following steps to create a Portal API user:

1. Click the triangle in the Users module tab to open the Actions menu and select "Create Portal API User".

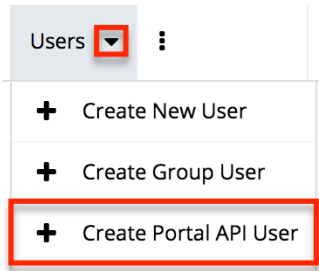

2. Enter a name and user name for the user.
3. In the Email Settings section, enter an email address or addresses for the API user. The group user's primary email address will be marked as "Primary" and you can also mark "Reply-to" if any automatic notifications from Sugar will be sent to this address.
4. On the Password tab, enter and confirm a password for the user following the password requirements set in Admin > [Password Management](#). This password will be used to log in to the API for this user.
5. Click "Save" to create the user.

Create

A screenshot of the user creation form. At the top, there are three buttons: 'Save' (highlighted with a red box), 'Cancel', and 'Reset User Preferences'. To the right of these buttons is a note: '* Indicates required fi'. Below the buttons are two tabs: 'User Profile' (highlighted with a red box) and 'Password'. The 'User Profile' tab is active and contains the following fields:

- User Profile** (expandable section)
- User Name: * API
- Status: * Active (dropdown menu)
- Name: * API User
- User Type: Portal API User (dropdown menu)
- Use for the Portal API. This type cannot login through the Sugar web interface.

Below the 'User Profile' section is the 'Email Settings' section, which contains:

- Email Address: api@example.com
- A red box highlights a '+' button next to the email address field.
- Primary (radio button, selected)
- Reply-to (radio button)

Creating Via Duplication

Often, administrators will find themselves in situations where multiple users must be created at once, whether it be when they are first setting up Sugar, a new group of employees is going to be using Sugar, etc. For situations such as these, one user can be configured and additional users can be quickly set up using the Copy option available on the record's detail view. When duplicating a user, all fields are populated from the original record to the duplicated one, except for the User Name field and password fields.

Note: The Copy option is not available for instances that use SugarIdentity.

Use the following steps to create a user by duplicating an existing user:

1. Navigate to the detail view of the user you would like to duplicate.
2. Click the Actions menu and select "Copy".

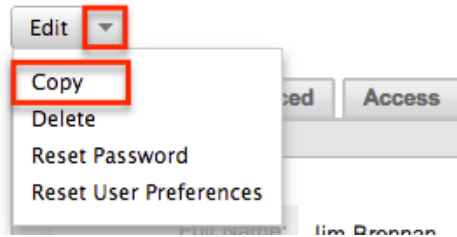

3. The displayed edit view is pre-populated with the original user's values, except for the user name and password.
4. Populate the "User Name" for the new user and edit any other fields or preferences to be specific to the new user. Fill in any information for the new user that did not exist on the original user.
5. If the system-generated password feature is not enabled in [Password Management](#), a Password tab will appear to the right of the User Profile tab where administrators can manually create a password for the user. Please note that the password requirements listed on the right will be checked off as the new password meets the required conditions.

Note: For instances that use [SugarIdentity](#), administrators will not be able to manually change or reset the user's password via the user's profile. Users can instead click the "Forgot Password?" link on the Sugar login screen to reset their passwords.

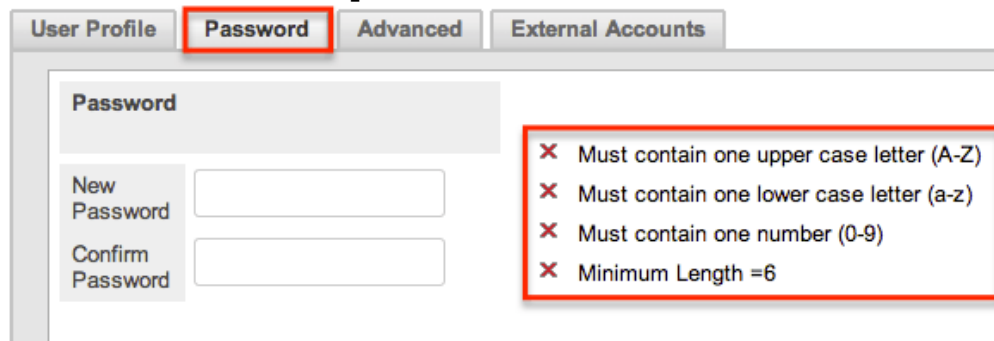

Note: If the system-generated password feature is enabled, this tab will not be available. Instead, a system-generated password will be sent to the user upon completion of the creation process.

6. Click "Save".

The new user is now created and available for use. This process is applicable to all [user types](#).

Creating Via Import

The import function in Sugar allows you to push multiple user records into Sugar using a comma (or another character) delimited file instead of creating them one-

by-one. Use the following steps to import users via the Import Users option. For more information on importing records to Sugar, please refer to the [Import](#) documentation.

Note: The Import Users option is not available for instances that use SugarIdentity. Administrators can access the Cloud Settings console to [import](#) a list of new users using a .csv file.

1. Click the triangle in the Users module tab to open the Actions menu and select "Import Users".

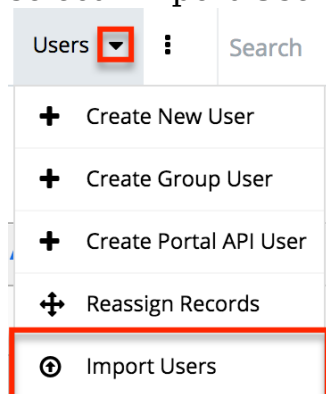

2. In Step 1, select the source of the data you are importing. Click "Next".
3. In Step 2, select the import file and choose "Create new records only". Click "Next".
4. In Step 3, confirm the import file properties. Click "Next".
5. In Step 4, confirm the field mappings for the import. Click "Next".
6. In Step 5, configure any fields you would like to use for duplicate checking.
7. In Step 6, view the import results.
 - The Created Records tab will show all of the new user records.
 - The Duplicates tab will show any records in the file that were detected as a duplicate and thus not imported from the duplicate check in Step 5 of the Import Wizard.
 - The Errors tab will show records that were not imported due to errors detected during import.

Viewing Users

There are various options available for viewing user records in Sugar including via Users recently viewed, Users list view, Users detail view, dashlets, and reports.

Note: If your instance uses SugarIdentity, then you can also view the user's basic and employment-related information in [SugarIdentity](#) via the Cloud Settings console.

Viewing via Recently Viewed

As you work, Sugar will keep track of which users you have recently viewed. Click the Actions menu in the Users module tab to see a list of your most recently viewed users, and click each name to open the user in detail view.

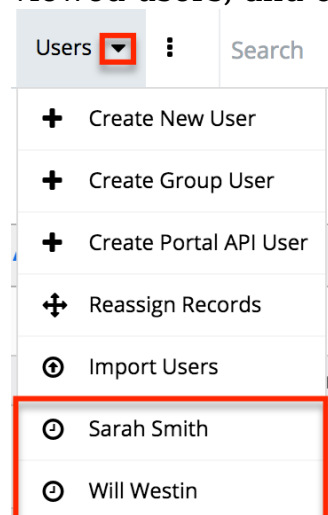

Viewing via List View

The Users list view displays all user records meeting the current search criteria. To access the list view, navigate to Admin > User Management. While the list view shows key user fields, you can click the user's name to open the record in detail view. For more information on viewing users via list view, please refer to the [Users List View](#) section of this documentation.

Viewing via Detail View

The Users detail view displays thorough user information including all user fields followed by subpanels of the user's related records belonging to various modules. The detail view also provides the Access tab, which allows [Teams](#) and [Roles](#) to be related to the user. Any admin user can click a user record's link from anywhere in the application, including from the Users list view to access the user's detail view. For more information on viewing the user's detail view, please refer to the Users Detail View section of this documentation.

Viewing via Dashlets

The Home page displays a collection of Sugar Dashlets which allow users to get a quick view of various records, activities, reports, etc. Clicking a user's name from

any dashlet will open the user in detail view and administrators can make changes to the user's profile as necessary. For more information on using dashlets, please refer to the [Dashboards and Dashlets](#) documentation.

The screenshot shows the 'My Dashboard' interface. On the left is a 'Pipeline' dashlet for '2017 Q4' with a chart showing 'Needs Analysis' at \$866 (1). On the right is a 'Contacts' table with columns: Name, Account Name, Office Phone, Title, and User. The 'User' column is highlighted with a red box, showing links to user profiles for Sarah Smith, Sally Bronsen, and Sally Bronsen.

Name	Account Name	Office Phone	Title	User
Karly Loughman	Smallville Resources Inc	(312) 353-8030	Senior Product Manager	Sarah Smith
Simone Lawrence	AB Drivers Limited	(120) 579-3907	VP Operations	Sally Bronsen
Jessi Han	Powder Suppliers	(552) 170-1757	President	Sally Bronsen
Roderick Swarthout	Slender Broadband Inc	(157) 752-1793	VP Operations	Sally Bronsen

Viewing via Reports

Administrators have the option to build, run, and manage reports to gather key data from records within Sugar. When building a report, you may either create a report based on the Users module or add links to the Users module in a report based on a module related to Users. Once the report is run, you can view the user record's detail view simply by clicking the user's name in the report results. Please note that you can only access user detail views via the Rows and Columns and Summation with Details-type reports as Summation and Matrix-type reports do not include hyperlinks in their display columns. For more information on using reports, please refer to the [Reports](#) documentation.

Name: Users Report	Type: Rows and Columns Report
Modules: Users	Teams: Global
Display Columns: User Name, Is Administrator, Status	Assigned to: Administrator
Schedule: None	
Filters: None	

User Name	Is Administrator	Status
admin	<input checked="" type="checkbox"/>	Active
chris	<input type="checkbox"/>	Active
jim	<input type="checkbox"/>	Active

Searching Users

The Users module's list view includes Basic and Advanced Search functionality to help you locate users easily and effectively. Once the search is performed, the

relevant search results will be displayed in the Users list view below. Please note that Sugar automatically appends the wildcard character (%) to the end of your search phrase. This allows the system to pull up all records that include the keyword entered in the search. If you would like to broaden the search, you can use the "Wildcard" (%) at the beginning of your text as well (e.g. %manager). This will pull up any record that has the word "manager" in the name, regardless of how it starts or ends (e.g. "Department Manager", "Product Manager" or "Project Manager").

For more information on using the various search methods as well as how wildcards are used, please refer to the [Search](#) documentation.

Basic Search

Basic search offers only Full Name as a searchable field. From the Basic search panel, you can click "Advanced Search" to access additional search functionality.

Search Users



The image shows a search interface with a text input field labeled "Full Name", followed by three buttons: "Search", "Clear", and "Advanced Search". The "Advanced Search" button is highlighted with a red rectangular border.

The buttons available in the Basic Search panel are also available in Advanced Search.

- **Search** : Click the Search button or press your Return/Enter key to perform the search.
- **Clear** : Click the Clear button to clear all criteria from the searchable fields.

When you run a search, Sugar will return records matching the criteria you typed in the Full Name search box. Once the search is complete, the relevant results will populate in the [list view](#) below the search panel. To see all user records, simply click "Clear" and then "Search" to perform a blank search with no filters.

Administrators can also configure what fields appear on the Users Basic Search via Admin > Studio. For more information on editing the Basic Search layout, please refer to the [Studio](#) documentation.

Advanced Search

Advanced Search offers a more in-depth search experience than Basic Search including additional fields, layout options, and saved search capability. From the

Advanced search panel, you can click "Basic Search" for simplified searching.

The buttons, checkboxes, and dropdowns available in Advanced Search have the following functions:

- **Search** : Click the Search button or press your Return/Enter key to perform the search.
- **Clear** : Click the Clear button to clear all criteria from the searchable fields.
- **Layout Options** : Use the expandable Layout Options section to configure your list view. For more information, please refer to the Layout Options section of the [Search](#) documentation.
- **Saved Searches** : Save, recall, update, and delete searches that you use often. For more information, please refer to the Saved Search section of the [Saved Search](#) documentation.

When you run a search, Sugar will return records matching all (as opposed to any) of the fields and checkboxes for which you have given values. For example, if you select "Is Administrator" as "Yes" and enter in a "First Name" to search, Sugar will only return the user records that have a matching first name and are admins. Once the search completes, the relevant results will populate in the [list view](#) below the search panel. To see all user records, simply click "Clear" and then "Search" to perform a blank search with no filters.

Administrators can configure what fields appear on the Users Advanced Search via Admin > Studio. For more information on editing the Advanced Search layout, please refer to the [Studio](#) documentation.

Users List View

The Users list view displays all user records meeting the current search criteria. You can view the basic details of each user within the columns of fields.

You have the option to change what fields are displayed in list view by configuring your layout options available in Users Advanced Search. For more information on configuring your list view, please refer to the Layout Options section of the [Search](#) documentation. You can also change what fields are visible in the list view via Studio. For more information on editing list view layouts, please refer to the [Studio](#) documentation.

Checkbox Selection

You can perform actions on user records directly from the list view by first

selecting the desired records. To select individual user records on the Users list view, mark the checkbox on the left of each row. To select or de-select multiple user records on the list view, use the options in the checkbox dropdown menu.

- **Select This Page** : Selects all records shown on the current page of user results.
- **Select All** : Selects all records in the current search results including all pages of user results.
- **Deselect All** : De-selects all records that are currently selected.

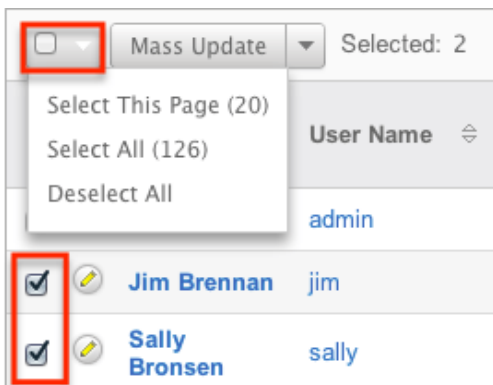

Actions Menu

The Actions menu to the right of the checkbox dropdown allows you to perform various actions on the currently selected records.

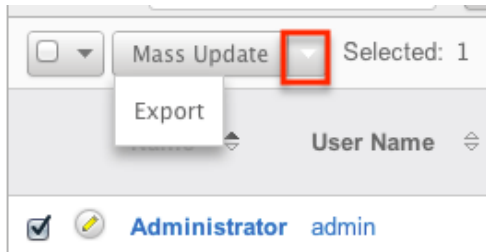

The options in the Actions menu allow you to perform the following operations:

Menu Item	Description
Mass Update	<p>Mass update one or more users at a time</p> <p>Note: For instances that use SugarIdentity, the administrator will need to access SugarIdentity via the Cloud Settings console to mass update the Status and User Type fields.</p>

Pagination

List view displays the current search results broken into pages that you can scroll through rather than potentially displaying thousands of rows at once. To the right just below the search panel you can see which records of the total results set are currently being displayed. The two single-arrow next and previous buttons can be used to scroll through the records page-by-page. The two double-arrow first and last page buttons allow you to skip to the beginning or the end of your current results.

By default, Sugar displays 20 records per list view page, but administrators can change the number of records displayed via Admin > System Settings. For more information on changing the number of displayed records, please refer to the [System](#) documentation.

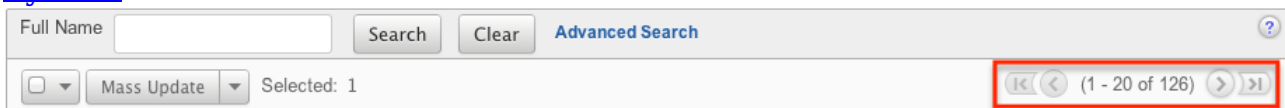

Column Sorting

List view provides the ability to sort all of the current search results by a field column in either ascending or descending order. To sort by a field or switch the sort direction, click the column header noting that the fields which allow sorting will have a pair of arrows in the column header. The list view may be sorted by only one column at a time. You can also set a default order-by column using the layout options in Advanced Search to specify which field to automatically sort results by in the list view. For more information on setting a default column sort, please refer to the Layout Options section of the [Search](#) documentation.

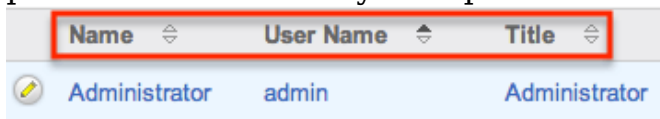

Users Detail View

The Users detail view displays thorough user information including all user fields which are grouped by default into the User Profile, Advanced, and Access panels. You can also view information from records related to the Users module as subpanels below the detail view. For more detailed information about adding

relationships, please refer to the [Studio](#) documentation. The detail view can be reached by clicking a user record's link from anywhere in the application including from the Users list view.

Note: If your instance uses SugarIdentity, then you can also view the user's basic and employment-related information in [SugarIdentity](#) via the Cloud Settings console.

Administrators have the ability to change what fields are visible in the detail view by configuring the field groupings via Admin > Studio. For more information on editing detail view layouts, please refer to the [Studio](#) documentation.

Actions Menu

The Actions menu on the top left of each user's detail view allows you to perform various actions on the current record. Please note that administrators in Sugar can change the action items to be displayed as separate buttons instead of a dropdown menu via Admin > System Settings. For more information on how to configure the actions menu, please refer to the [System](#) documentation.

Note: The Copy, Delete, and Reset Password options are not available for instances that use [SugarIdentity](#).

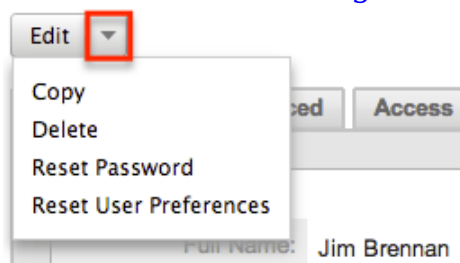

The options in the Actions menu allow you to perform the following operations:

Menu Item	Description
Edit	Edit this user Note: For instances that use SugarIdentity, certain user fields (e.g. First Name, Last Name, Title, Work Phone) can only be edited in SugarIdentity via the Cloud Settings console.
Copy	Duplicate this user

	Note: The Copy option is not available for instances that are SugarIdentity-enabled.
Delete	Delete this user Note: The Delete option is not available for instances that are SugarIdentity-enabled. Administrators can access SugarIdentity via the Cloud Settings console to delete a user from Sugar.
Reset Password	Remove the user's current password and email a new one Note: The Reset Password option is not available for instances that are SugarIdentity-enabled. Users can instead click the "Forgot Password?" link on the Sugar login screen to reset their passwords.
Reset User Preferences	Revert all user preferences back to system-wide settings

Tabs

The detail view for a user is broken up into multiple tabs to better organize the different fields available in the Users module. Some of the available tabs in the user's profile are "User Profile", "Advanced", and "Access". A Downloads tab is also available when viewing your own profile. For more information on viewing your personal user profile, please review the [User Preferences](#) documentation.

User Profile

The User Profile tab displays information specific to the user such as the user's name, user type, employment status, contact information, etc. Administrators have the ability to configure the User Profile layout via Admin > [Studio](#). For more information on editing the user's profile in the Users module, please refer to the [Editing Via Detail View](#) section of this documentation.

Note: For instances that use SugarIdentity, certain [fields](#) (e.g. First Name, Last Name, Title, Work Phone) in the user's profile are read-only and can only be edited in [SugarIdentity](#) via the Cloud Settings console.

Advanced

The Advanced tab shows information specific to the user's preferences in Sugar. Information such as the user settings, locale settings, PDF settings, etc. can be easily viewed under this tab. Please note that the layout of this tab cannot be edited in Studio. However, you can edit the information under the tab by clicking the Edit button on the user's detail view. For more information on editing the user's profile, please refer to the [Editing Via Detail View](#) section of this documentation.

Access

The Access tab summarizes the user's Team and Role settings so that it can easily be viewed in one place. The Access table, Roles subpanel, and My Teams subpanel will appear under the tab.

- **Access Table** : The Access table summarizes the set of permissions assigned to the user and allows you to view the type of access they have along with the actions (e.g. View, Edit, Delete, etc.) they can perform in Sugar. This table is very similar to what appears in Admin > Role Management, but this table is not editable in the Users module.
Note: Users with more than one role assigned will have the more restrictive role setting prevail on the access table. For example, if one role allows the user to delete records in the Contacts module, but the other role does not allow record deletion, the user will not be able to delete records in the Contacts module.

The table will list the modules in rows on the far left with column headers representing the type of action (e.g. Delete, Edit, Export, etc.) users can perform in each module. For more information on role settings, please refer to the [Roles](#) documentation.

	Access	Access Type	Delete	Edit	Export	Import	List	Mass Update	View
Accounts	Enabled	Normal	None	Owner	None	None	All	None	All

- **Roles Subpanel** : The Roles subpanel will list all of the roles assigned to the user along with the description of each role. Roles work in conjunction with teams to form a robust security model for non-admin users in Sugar. Roles control three different layers of access for users within Sugar: module, field, and action-level access. System administrators can easily assign roles to the user as well as remove roles via the Roles subpanel.
- **Teams Subpanel** : The Teams subpanel will list all of the teams assigned to the user along with the description of each team. The defined permissions determine what records a user is and is not able to access. Teams are used in conjunction with roles to form a robust security model for non-admin users in Sugar. System administrators can easily assign

teams to the user as well as remove teams via the My Teams subpanel. For more information on team settings, please refer to the [Teams](#) documentation.

Subpanels

Subpanels can be added to the Users module by creating relationships via Admin > Studio. All available subpanels will appear at the bottom of the user's detail view. For more information on adding relationships, please refer to the [Relationships](#) section of the Studio documentation.

The User Holidays subpanel is the only subpanel available for the Users module out of the box. This subpanel allows administrators to select specific days that the user will not be working. This is used when calculating project timelines in the Projects module. Holidays can be added using the Create button and inputting a date and description of the holiday.

⤴ User Holidays

<input type="button" value="Create"/>	
Holiday Date: ⤴	Description:
01/01/2014	New Years Day

Editing Users

The user's profile can be easily edited by the user or the administrator by clicking the Edit button on the user's detail view. In addition, changes to the user's profile can be made via the Users list view as well by clicking the Pencil icon to the left of the user's name. Editing the user's profile from the detail view and list view opens the full edit view layout which includes all of the relevant fields that can be updated as necessary.

Note: If your instance uses SugarIdentity, then you will need to access SugarIdentity via the Cloud Settings console to [update](#) certain [user fields](#).

Save Cancel Reset User Preferences

User Profile Password Advanced External Accounts

⌵ User Profile

User Name: *	<input type="text" value="will"/>	First Name:	<input type="text" value="Will"/>
Status: *	<input type="text" value="Active"/>	Last Name: *	<input type="text" value="Westin"/>
User Type:	<input type="text" value="Regular User"/>	User can access modules and records based on team security and r	
Avatar:			

⌵ Employee Information

Employee Status:	<input type="text" value="Active"/>	Display Employee Record:	
Title:	<input type="text" value="Sales Manager East"/>	Work Phone:	

Editing via Detail View

You can edit users by clicking the Edit button on the upper left of the user's detail view. Once the edit view layout is open, update the necessary fields, then click "Save" to preserve the changes made. For more information on the detail view, please refer to the [Users Detail View](#) section of this documentation.

Edit

User Profile Advanced Access

⌵ User Profile

Full Name:	Jim Brennan
Status:	Active

External Accounts

When viewing the edit view of a user, the External Accounts tab appears to the right of the Advanced tab. The External Accounts functionality allows you to connect external applications to Sugar, such as GoToMeeting, Google Drive (Google Docs), and WebEx. To create an external account record, follow the following steps:

1. Navigate to the [detail view](#) of the user to whom you would like to add the account.
2. Click on the External Accounts tab then click "Create".

[Jim Brennan](#) » Edit

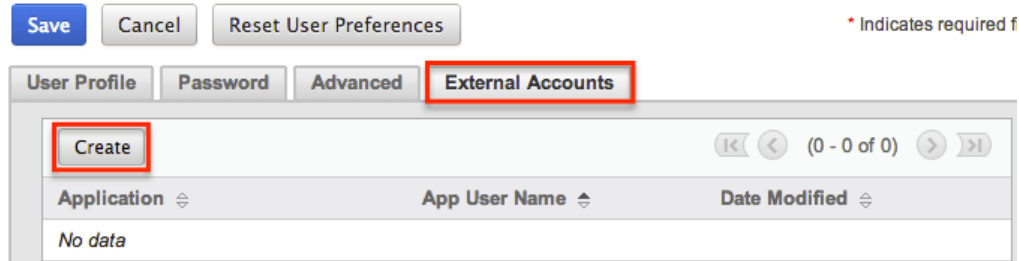

3. Select the application you will be connecting to from the Application dropdown field. The fields available to complete will vary depending on the application (GoToMeeting, Google, WebEx) selected. Please note that additional external applications will appear on the list if they are enabled via Admin > Connectors.
4. Enter the necessary information for the external application and click "Connect".

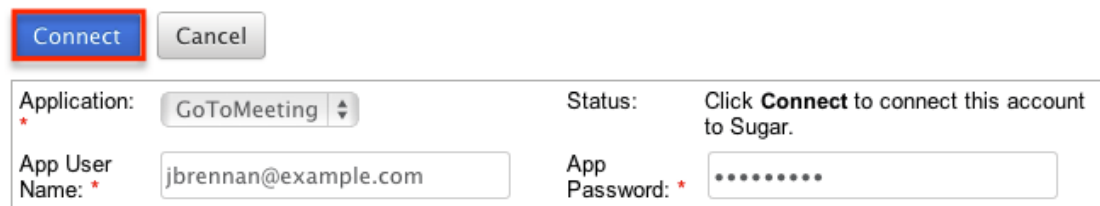

Should you wish to prevent users from creating external accounts, you can remove the Create button for users in the External Accounts tab of their profiles by disabling the External Accounts module via a [role](#) assigned to those users. Please note the "Access Type" setting will not affect this module. Furthermore, editing or deleting the external account can be done by clicking the account's name on the External Account list view. This brings you back to the edit view with the necessary options and available fields.

The out of the box connectors perform the following functions:

- **GoToMeeting** : The GoToMeeting connector allows you to create meetings in Sugar that are tied to your GoToMeeting account and will show as such on your GoToMeeting account. This allows the user to, after creating the Sugar meeting record, start the GoToMeeting directly from within Sugar's [Meetings](#) module.
- **Google** : The Google connector allows you to create [documents](#) within Sugar that, instead of uploading a file to the server hosting Sugar, allows the user to link to an existing Google document from Google Drive or to upload a file to that account. When clicking on a document name in the Documents module or any Documents subpanels, the user will be brought

to Google Drive instead of the download being initiated.

- **WebEx** : The WebEx connector allows you to create meetings in Sugar that are tied to your WebEx account and will show as such on your WebEx account. This allows the user to, after creating the Sugar meeting record, start the WebEx meeting directly from within Sugar's [Meetings](#) module.

Editing via List View

You can edit users via the list view by clicking the Pencil icon to the left of each user's name. The full edit view layout will open allowing you to make any changes to the user's profile as necessary. Once the user's profile has been updated, click "Save" to preserve the changes. For more information on the list view, please refer to the [Users List View](#) section of this documentation.

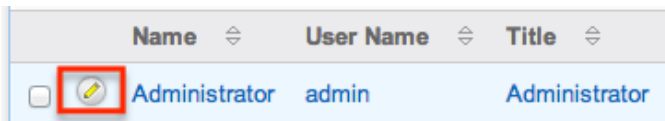

	Name	User Name	Title
<input type="checkbox"/>	Administrator	admin	Administrator

Deactivating Users

When a user is no longer a member of your organization, it is best practice to deactivate them instead of deleting them. This ensures that the user will no longer be able to log in to Sugar, but any historical information tied to the user will still be available. Please note that deactivating user records will not update any related records and will only prevent the user from being selected (e.g. Assigned to). However, the [Reassign Records](#) tool will be presented and can be used to reassign all of the user's records.

Note: Users that have been deactivated do not count towards your licensed user count.

Note: If your instance uses SugarIdentity, you will need to access [SugarIdentity](#) via the Cloud Settings console in order to [deactivate](#) a user from Sugar.

Use the following steps to deactivate a user and reassign their records:

1. Navigate to Admin > User Management and click the user you wish to deactivate.
2. Edit the user record and change the Status field to "Inactive". Click "Save".
3. A pop-up message will display asking if you would like to reassign all of the user's records. Click "Yes" if you wish to proceed.
4. You will then be presented with the Reassign Records tool. Follow the steps

on this page to complete the deactivation. For more information, please review the [Reassigning Records](#) section.

5. Once the reassignment is complete, the user will be deactivated and no longer able to log in to Sugar.

Deleting Users

If a user record is invalid or should no longer appear in your organization's Sugar instance, it may be deleted from the Users detail view. Please note that deleting user records will not delete any related records and will only prevent the user from being selected (e.g. Assigned to). When a user is no longer a member of your organization, it is best to [deactivate](#) them by changing the Status field to "Inactive" instead of deleting them. This way, any historical information tied to the user will still be available, but the user will no longer be able to log in to Sugar.

Note: If your instance uses SugarIdentity, you will need to access [SugarIdentity](#) via the Cloud Settings console in order to [delete](#) a user from Sugar.

Use the following steps to delete a user and reassign their records:

1. Navigate to Admin > User Management and click the user you wish to delete.
2. Select "Delete" from the [Actions Menu](#).
3. A pop-up message will display asking for confirmation. Click "OK" to proceed.

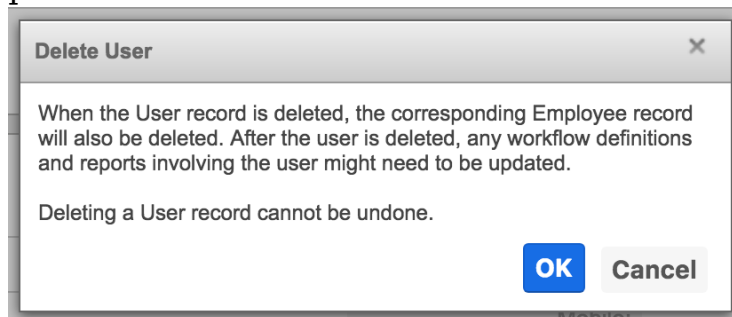

4. You will then be presented with the Reassign Records tool. Follow the steps on this page to complete the deletion. For more information, please review the [Reassigning Records](#) section.
5. Once your reassignment is complete, the user will be deleted, and you can freely navigate around Sugar.

Exporting Users

Sugar's Export option allows users to download all fields for the selected users to

their computers as a .CSV (comma-separated values) file. This may be useful when needing to use User data with other software such as Microsoft Excel or to update existing records by exporting, making changes, and then importing the altered users back into Sugar. For more information on updating existing records via import, please refer to the [Import](#) documentation. Please note that for instances that use [SugarIdentity](#), the import option is not available to update existing user records.

Users may be exported from the Users list view by selecting "Export" from the Actions menu. User data can also be exported via the Reports module by creating or accessing reports containing specifically chosen fields for users and their related record(s). For more information on exporting records in Sugar, please refer to the [Export](#) documentation.

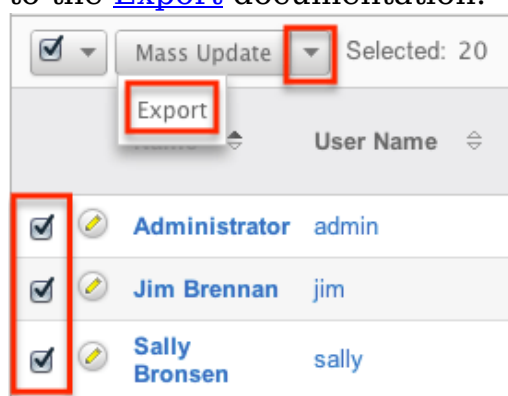

Due to PHP memory limitations on the server, there may be occasions when the application times out while exporting a large number of user records. If you encounter an error when performing this action, we recommend selecting the records in smaller batches.

Mass Updating Users

Mass Updating allows users to make the same change to multiple user records at once from the Users list view. Users with administrator or developer-level access can control which fields are available to change during mass update via Admin > Studio. Currently, only fields with the data type of date, datetime, dropdown, multiselect, and radio may be altered during a mass update. Due to PHP memory limitations on the server, there may be occasions when the application times out while updating a large number of user records. If you encounter an error when performing this action, we recommend selecting the records in smaller batches. For more information on configuring mass update, please refer to the [Studio](#) documentation in the Administration Guide.

Note: For instances that use [SugarIdentity](#), the administrator will need to access [SugarIdentity](#) via the Cloud Settings console to mass update the Status and User

Type fields.

Use the following steps to mass update user records from the list view:

1. Navigate to the Users list view via Admin > User Management.
2. Use the list view's [Basic](#) or [Advanced Search](#) to identify users you wish to modify.
3. Select the desired users individually or using the [checkbox dropdown's](#) options.
4. Choose "Mass Update" from the Actions menu.

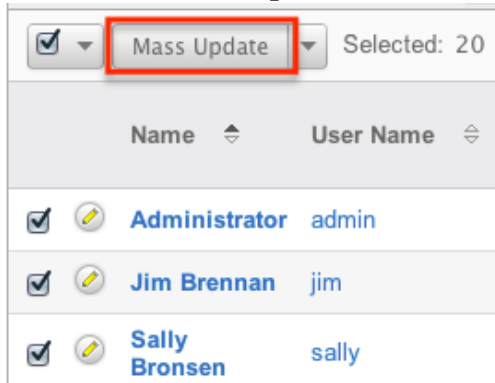

5. Scroll to the Mass Update panel and set values for the fields you wish to alter.
6. Click "Update" to save the changes to all of the currently selected user records.

Mass Update

Is Administrator	<input type="text" value="-none-"/>	Status	<input type="text" value="-none-"/>
User Type	<input type="text" value="-none-"/>	Display Employee Record	<input type="text" value="-none-"/>
Employee Status	<input type="text" value="-none-"/>	IM Type	<input type="text" value="-none-"/>
Reports to	<input type="text"/> <input type="button" value="Select"/>	Email Client	<input type="text" value="-none-"/>
Preferred Language:	<input type="text" value="-none-"/>		

Resetting User Preferences

As users make changes while navigating around Sugar, their preferences are stored in the Sugar database. This includes preferences such as sort orders on list view, previous searches on both basic and advanced searches, and settings in the Advanced tab of the user profile. Users can reset their preferences back to the default out-of-the-box settings, which will revert the user's changes made in Sugar. Please note that this action cannot be undone. If the user is currently logged in,

the changes will not take effect until the user is logged out and then back in.

Note: Resetting a user's preferences is the only way to allow a user access to Sugar if they have been locked out using the [Login Lockout](#) feature in Password Management.

Use the following steps to reset a user's preferences:

1. Navigate to the user's detail view via Admin > User Management and select the user (e.g. Jim Brennan) from the list view.
2. Select "Reset User Preferences" from the [Actions menu](#).

Jim Brennan

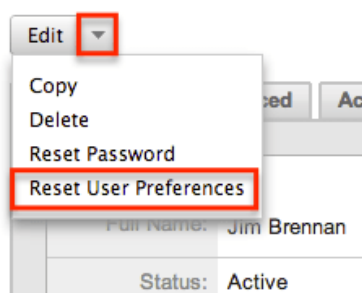

3. A pop-up box will appear confirming the reset. Click "OK" to proceed.

Resetting User Passwords

Administrators have the option to manually set or reset users' passwords as necessary. First, determine the state of the system-generated password feature in Admin > [Password Management](#), and then choose one of the following methods:

System-generated password feature enabled	System-generated password feature disabled	SugarIdentity enabled
<ol style="list-style-type: none">1. Navigate to the user's detail view via Admin > User Management.2. Select "Reset Password" from the Actions menu.	<ol style="list-style-type: none">1. Navigate to the user's detail view via Admin > User Management.2. Click the Edit button on the upper left of the detail view.	Users click the "Forgot Password?" link on the Sugar login screen to reset their own passwords.



3. Click "OK" in the confirmation pop-up.



3. On the Password tab, enter the new password.

4. Click "Save" to confirm your change.

Note: The user needs to log out and then back in for the change to take effect.

Reassigning Records

Reassign Records is a tool available in the Users module for administrators to change the Assigned To and Team fields for a specific user's records. This is best used when a user is changing departments, teams, or roles within the organization, or if the user is no longer an employee or using Sugar. The Reassign Records tool is automatically presented when [deleting](#) or [deactivating](#) a user. Please note that reassigning records cannot be undone in Sugar.

Use the following steps to reassign records:

1. Navigate to the Users module via Admin > User Management.
2. Click the triangle in the Users module tab to open the Actions menu and select "Reassign Records".

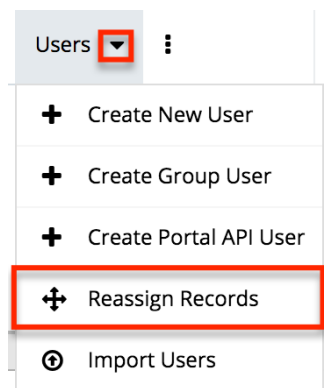

The Reassigning Records tool can also be accessed during the process of [deleting](#) or [deactivating](#) a user, where it is used to reassign a user's records before deleting or deactivating them.

3. Select the user to whom the records are already assigned in the From User field.
4. Select the user to whom the records will be assigned to in the To User field.
Note: You can select the same user in both fields if you are just changing the team for all of the user's records.
5. Select which team(s) the records will be assigned to in the Set Teams to field.
6. Select the module(s) you wish to include in the record reassignment. Multiple modules can be selected by holding down the Control key when using a PC or the Command key when using a Mac.

Next > Clear Cancel

From User:
Chris Olliver

To User:
Max Jensen

Set Teams to:
Primary
Global

Modules to Include in Reassignment:

- Accounts
- Bugs
- Calls
- Campaigns
- Cases
- Contacts

Accounts Filters

Type:

- none-
- Analyst
- Competitor
- Customer

7. Selecting certain modules will display specific filters (e.g. Type) which can be applied to the module. Use these filters if you do not want to include all records assigned to the user. The list of modules and their filter fields are as follows:

Module	Filter Field
Accounts	Type
Bugs	Status
Calls	Status
Cases	Priority Status
Dashboards	Default Dashboard
Opportunities	Sales Stage Type
Tasks	Status

8. After selecting any filters, click "Next" to access the reassignment summary.
9. If you would like to see a detailed list of the changes that were made, click

"Verbose Output". This list will include a link to the changed records and a summary of changes that were made.

10. If you would like the changes to show in the Change Log for the changed record, have any relevant [workflows](#) fire, or have assignment notifications sent out, please click the Include Workflow/Notifications/Audit checkbox. **Note:** This process performs a large set of actions at once and may take a long amount of time to complete.

Assessing Accounts

8 records from Accounts will be updated.

Include Workflow/Notifications/Audit (significantly slower)

Assessing Calls

6 records from Calls will be updated.

Include Workflow/Notifications/Audit (significantly slower)

Assessing Contacts

23 records from Contacts will be updated.

Include Workflow/Notifications/Audit (significantly slower)

11. Click "Next" to complete the reassignment.
12. The final summary page will show how many records were affected and if any errors occurred during the reassignment. Click "Return" to return to the main screen of the Reassigning Records tool.

Processing Contacts

Update complete: 23 affected

Return

Due to PHP memory limitations on the server, there may be occasions when the application times out while reassigning a large number of user records. If you encounter an error when performing this action, we recommend reassigning records in smaller batches via each module's mass update option.

Last Modified: 2020-09-26 13:56:11

Sugar Connect

Overview

The Sugar Connect section of the Administration page allows you to connect to various SugarCRM online resources such as License Management, SugarCRM Support, Sugar Updates, and Online Documentation. This documentation covers how to manage your Sugar license, check for Sugar updates, as well as access Sugar's support and online documentation.

License Management

The License Management page allows administrators to edit and revalidate their Sugar license as well as view information such as the download key, expiration date, number of users, etc. Sugar is purchased with a set number of user seats for each Sugar product (e.g. Sugar Professional, Enterprise, Sell, and Serve). Sugar users, including administrators, are then assigned to one or more products via the [License Type field](#) on each's user record. If an instance has more active regular and administrator users than have been purchased for each license type, regular users will not be able to log in. Admin users will be able to log in but will be redirected to the Users module in order to correct the issue. Once enough users have been deactivated or additional seats have been purchased, regular users will be able to log in again. For more information, refer to the [Understanding User Types, License Types, and Sugar Licenses](#) article. SugarCloud customers can monitor the number of users counting against their license via the [SugarCloud Insights](#) page.

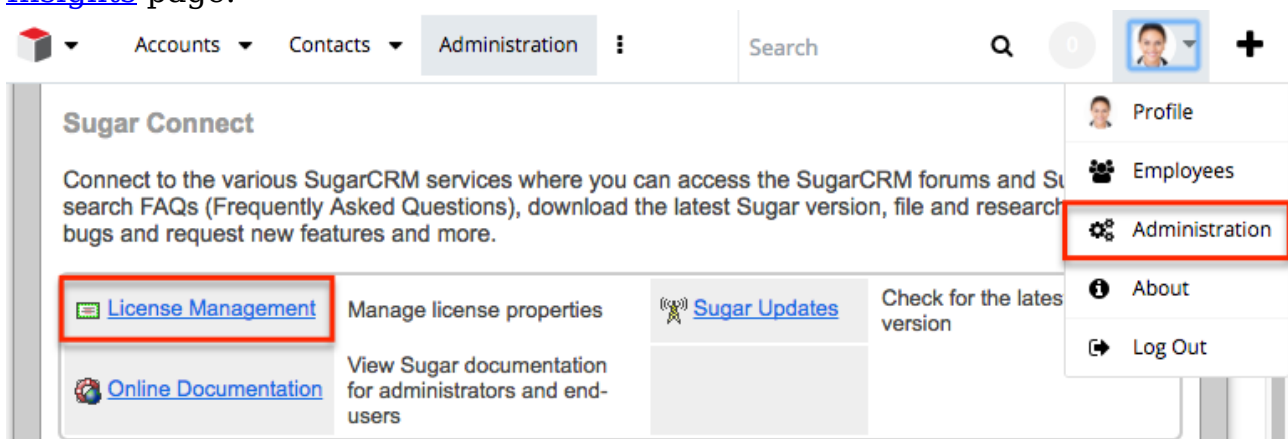

Download Key

The download key is a 32 digit alphanumeric key that is unique to your Sugar account. The number of user licenses your organization purchased, as well as the subscription expiration date is tied to your download key. Upon purchasing Sugar, you will receive a Welcome email containing your download key information which will need to be entered during installation of the Sugar application. Once the download key is entered in the system, the corresponding information such as the

expiration date, number of users, number of offline client licenses, and number of concurrent self-service portal users will automatically populate and be displayed in Admin > License Management.

Editing the License Key

Although rare, there may be times when system administrators will need to edit their license key via Admin > License Management. For example, some product changes (e.g. Professional to Enterprise) may result in a new license key being provided by SugarCRM. You will need to update the License Management page with the new license key to associate your account to the new Sugar product.

The fields in the License Management panel are as follows:

- **Download Key** : The download key associated to your Sugar subscription.
- **Expiration Date** : The date your Sugar license expires.
- **Number of Users** : The number of users allowed to access Sugar based on the number of purchased licenses.
- **Number of Offline Client Licenses** : The number of offline clients associated with your license key.
- **Number of Concurrent Self-Service Portal Users** : The number of self-service portal users associated with your license key.

The following steps cover editing the license key for your account when changing Sugar products as an example:

1. Navigate to Admin > License Management.
2. Click the Edit button and enter the download key associated to your new Sugar product.

License Management

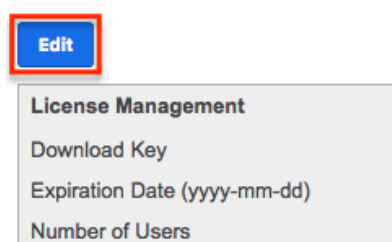

3. Once the download key is entered, click "Save".
 - The expiration date, number of users, etc. will automatically be updated based on the new download key.

License Management

The screenshot shows a 'License Management' form. At the top left, there are two buttons: 'Save' (highlighted with a red box) and 'Cancel'. Below the buttons is a form titled 'License Management' with the following fields:

License Management	
Download Key	<input type="text" value="Download Key"/>
Expiration Date	2017-03-01
Number of Users	150
Number of Offline Client Licenses	0
Number of Concurrent Self-Service Portal Users	0

Please note that when you save the new license key information, the system automatically checks it against the information in the SugarCRM database to make sure it is valid.

License Validation

The License Validation panel of the License Management page allows administrators to re-validate their license as necessary. Sugar automatically re-validates your license once every 90 days as long as a system administrator logs into Sugar within the 90 day period. However, if your system fails to communicate with the License Validation server through the internet or you are behind a firewall, you will have to re-validate the license via Admin > License Management. If the re-validation is successful, the Status field in the License Validation panel will display the timestamp of the successful validation. The validation key expiration date will be 90 days from the date of the last successful validation date.

License Expiration

Typically, Sugar licenses are purchased for a one year period (e.g. 01/03/2013 to 01/03/2014). Please note that you will be notified of your upcoming subscription renewal via email or call and a notification will appear in the Sugar cube on the upper left of your Sugar account regarding your license expiration. If the subscription is renewed past the expiration date, then administrators must re-validate their license via Admin > License Management in order to update the account with the new subscription. If the administrator does not re-validate the license, regular users will be prohibited from logging into Sugar until the license is successfully validated by the administrator.

Re-validating the License

Although Sugar automatically re-validates your license once every 90 days, there may be special circumstances where administrators must re-validate the license

via License Management. For example, if you renew your subscription after the expiration date or if you purchase additional users or license types mid-term, you will have to re-validate the license via Admin > License Management in order to update your Sugar account with the new subscription.

The fields in the License Validation panel are as follows:

- **Validation Key** : System generated validation key associated to your Sugar subscription.
- **Validation Key Expiration** : The date the validation key expires. The expiration date is typically 90 days from the last successful validation date.
- **Status** : The status displaying the timestamp of the last failed or successful validation.

Use the following steps to re-validate the license in Sugar:

1. Navigate to Admin > License Management.
2. Click the Re-validate button.



The system will communicate with the License Validation server to validate your license based on your Sugar subscription. If the re-validation is successful, then the status will reflect the date and time of the successful validation. If the system fails to connect successfully with the License Validation server and you cannot re-validate your license, use the [Manual Validation](#) option at the bottom of the License Validation panel.

Manual Validation

If your system fails to communicate successfully with the License Validation server through the internet, you have the option to perform a manual validation via Admin > License Management.

Use the following steps to perform a manual validation in Sugar:

1. Navigate to Admin > License Management.
2. Click the Manual Validation link located at the bottom of the License Validation panel.

License Validation	
Validation Key	[REDACTED]
Validation Key Expiration (yyyy-mm-dd)	2017-03-01
Status	Last successful validation : 2016-12-08 15:54 Last failed validation : 2016-12-06 15:50

If you experience persistent problems with automatic validation, please check your Proxy configuration in the [System Settings](#) admin panel. If your system environment prohibits your system from communicating to the license validation server through the internet, you should proceed with the [Manual Validation](#) steps.

- Click the Export Download Key button to export the sugarkey.lic file. Select "Save to Disk" in the pop-up window to save the file to your local machine then click "OK".

Manual Validation
Step 1: Generate a license key information file by clicking the following button.
Export Download Key

- Go to <http://updates.sugarcrm.com/license> and submit the sugarkey.lic file for validation.
 - If the validation is successful, the validation key file (sugarvalidationkey.lic) will be generated, and the system will prompt you to save the file.

SUGARCRM	
Please attach your download key:	
Choose File	No file chosen
Submit	

- Log back into your instance and navigate to the Manual Validation page (Admin > License Management > Manual Validation).
- On Step 3, choose the sugarvalidationkey.lic file on your local machine and click "Import".

Step 3: Transfer the validation key file (sugarvalidationkey.lic) back to the SugarCRM system. Import the validation key using this form below:	
Validation Key File(sugarvalidationkey.lic)	Choose File No file chosen Import

Once the validation key is imported successfully, you have completed the manual validation process. Sugar will update the validation status along with the Validation Key Expiration date for the license key.

Sugar Updates

The Sugar Updates page allows administrators to check for the latest available Sugar versions. By default, Sugar automatically checks for updates on a periodic basis to see if any version updates are available for your instance. If a new version

update is available, the Sugar Updates link in the Administration page will appear red and display the latest Sugar version next to it. Administrators can uncheck the automatic updates option in the Sugar Updates page if they do not wish to have the system automatically check for updated version releases.

Use the following steps to perform a manual check for Sugar updates:

1. Navigate to Admin > Sugar Updates.

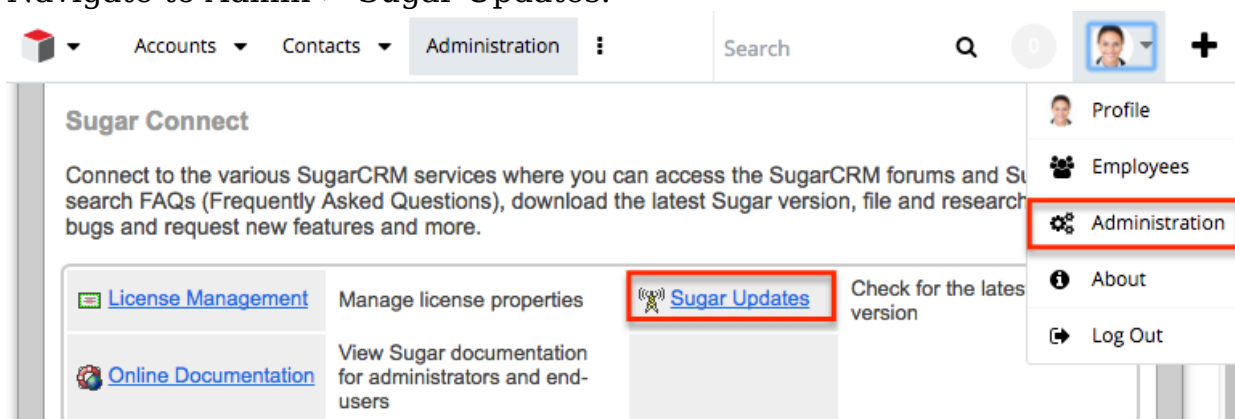

2. Click the Check Now button to see if a new update of Sugar is available.

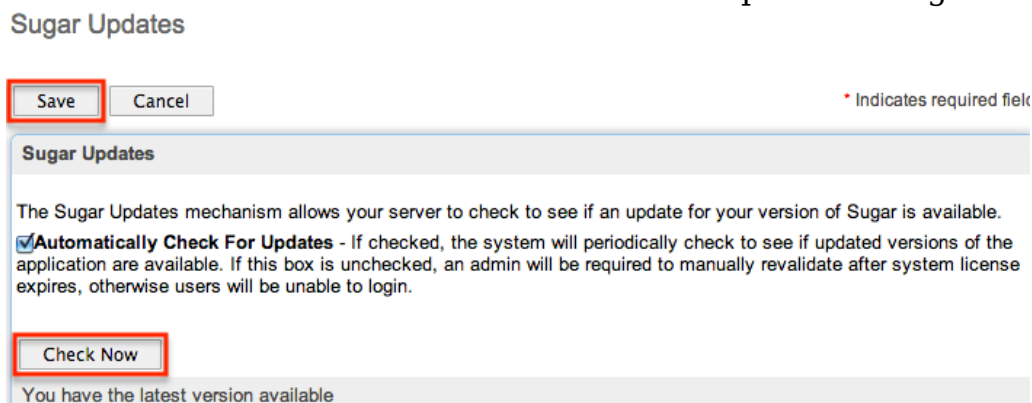

If there is an available version update, a message will appear below the Check Now button with the latest version along with a message to visit support.sugarcrm.com to retrieve and download the latest version. Please note that clients hosted on Sugar's cloud service are normally upgraded by the SugarCRM team on a predetermined schedule as releases are made available. On-Site clients will need to perform the upgrade themselves as Sugar is hosted on their servers. If the system detects that you have the latest version of Sugar, then the message will inform you that you have the latest version available.

Online Documentation

Administrators can easily access the documentation for their current Sugar product and version via Admin > Online Documentation.

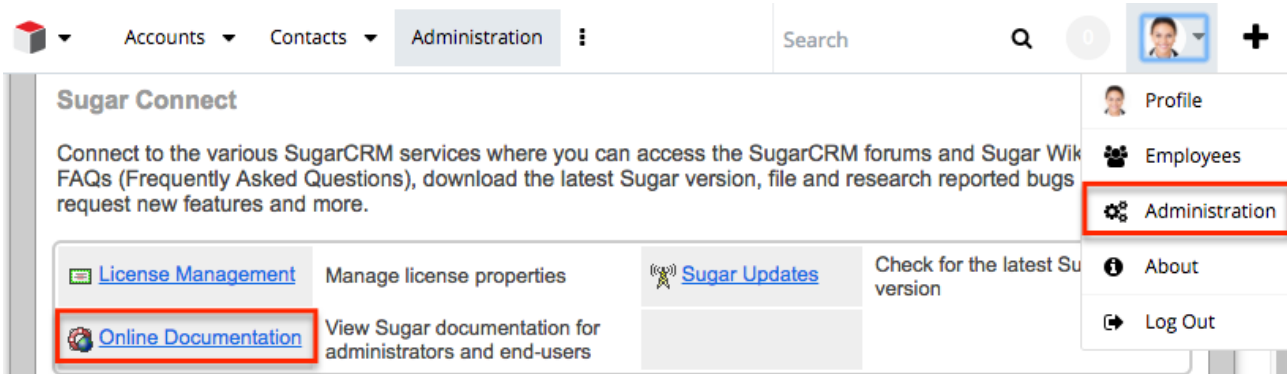

A new window will open directing you to the appropriate Administration Guide, which provides information about configuring and administering your Sugar instance. You can view specific sections of the Administration guide by selecting the various topic links (e.g. Users, System, Email) on the main page or from the Administration Guide tree menu to the left. You can also access the relevant Application Guide which provides information about the functionality available to end users. Simply click the down arrow at the top of the menu to the left of the Administration Guide and select the Application Guide link (e.g. Sugar Ultimate 7.8 Application Guide). To learn more about a specific module in Sugar, select the appropriate topic link (e.g. Accounts, Contacts) on the main Application Guide page or from the menu on the left.

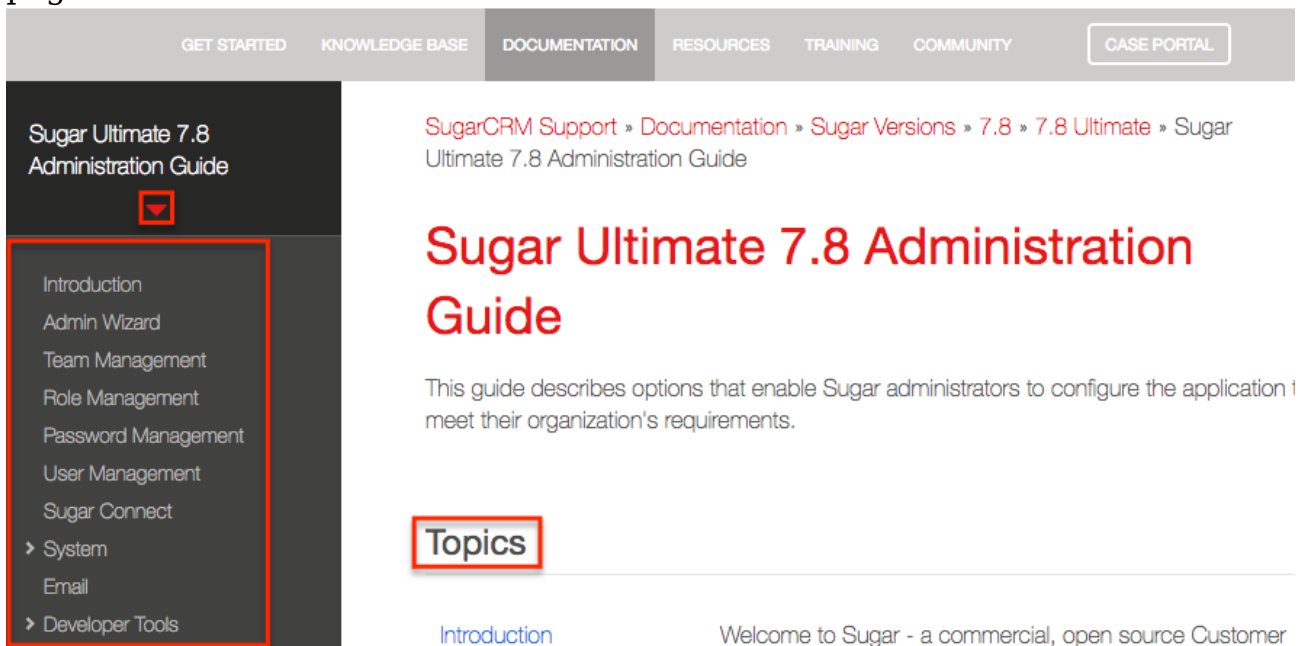

Please note that all users can view the online documentation as well by clicking the Help link in Sugar's footer from the home page or a Sidecar module's list view/record view. This will open the help pane which includes a link to the module's corresponding documentation. In addition, they can click the Documentation & Support link to open the SugarCRM Support page where they

can access the available documentation, knowledge base articles, case portal, etc.

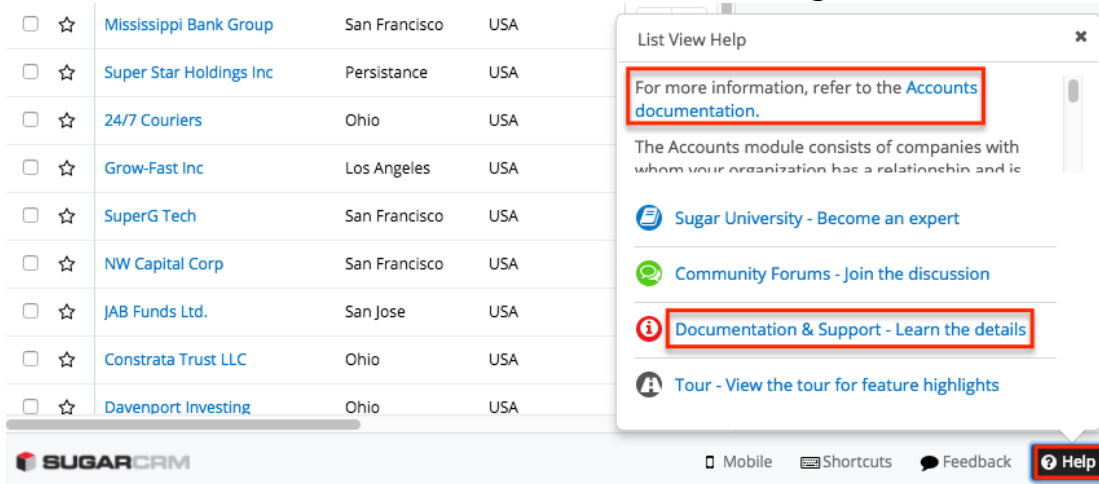

The Application and Administration Guides provide end-users and administrators with an in-depth look at configuring, customizing, and utilizing Sugar, as well as the various options available in the application. The Installation and Upgrade Guide provide users with the necessary instructions to properly install or upgrade their On-Site Sugar instance. The Supported Platforms page covers the supported components that are necessary to run the Sugar application. The Developer Guides provide developers with advanced information on configuring and customizing Sugar to best meet their organization's needs. The release notes cover feature enhancements, fixed issues, etc. that are included in the specific version release. Additional guides include instructions for using mobile applications, plug-ins for Microsoft Office, etc.

Last Modified: 2020-09-01 16:50:24

System

Overview

Sugar comes with the ability to configure many different system settings to personalize the way Sugar works. The System section is only available to administrative users and can be accessed via the Admin screen. The following sections are available options from the System section.

System contains the following menus:

System Settings	Configure system-wide settings
---------------------------------	--------------------------------

Locale	Set default localization settings for your system
Currencies	Set up currencies and conversion rates
Languages	Manage which languages are available for users
Search	Select modules for the Global Search and configure full-text searching
Connectors	Manage connector settings
OAuth Keys	OAuth key management
Import Wizard	Import records easily into the system
Backups	Back up web files for your Sugar instance
Repair	Check and repair Sugar
Diagnostic Tool	Capture system configuration for diagnostics and analysis
Tracker	Enable/Disable tracking
Scheduler	Set up scheduled events
PDF Manager	Manage templates for generated PDF files
Mobile	Select modules to appear in the Mobile applications
Web Logic Hooks	Configure actions to call out to code hosted outside of your Sugar instance to process specified actions.

System Settings

System Settings allows administrators to configure system-wide settings to your organization's specifications. The system settings are split across a few different panes of related information. Change the values in any of the panels and click "Save" to preserve your changes.

System Settings

Save
Restore
Cancel

User Interface

Listview items per page:

Prevent user customizable Homepage layout:

Alternatively, you can click "Restore" to restore the system settings back to default.

User Interface

The User Interface pane consists of a group of settings that affect the interface of Sugar. Use the following settings to configure the different aspects of the interface:

- **Listview items per page** : The maximum number of records to display per list view results set, as well as the search results set on the View All Results page for Global Search. By default, this is set to 20 records per results set. The system paginates lists that contain more than the specified number of list view items per page.
 - **Note:** The recommended setting is below 50 for acceptable performance levels. As additional fields are added to the list view, this number should be at the lower end of the recommended setting.
- **Subpanel items per page** : The maximum number of records to display on a page in subpanels. The system paginates lists that contain more than the specified number of records. Defaults to 5.
 - **Note:** The recommended setting is no more than 25 with lower values recommended when subpanels include many fields.
- **System Name** : The name of this instance of Sugar (e.g. "My Company CRM") that displays in the browser's title bar after the current page's title.

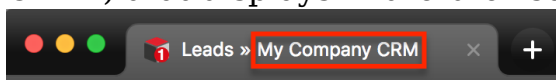

- **Show Full Names** : Select this option to set the default value for new users to display the full name of users instead of login names throughout Sugar.
- **Current Logo** : The current logo being used in the bottom left-hand corner of the footer bar.
- **Select Logo** : Click "Choose File" to navigate to and select a new logo for your system. The dimension should be 212 X 40 pixels, with the standard transparent background color, in PNG or JPG format.
- **Display Downloads Tab** : Select this option to display the Download tab in the User settings and provide users with access to Sugar plug-ins and other available files

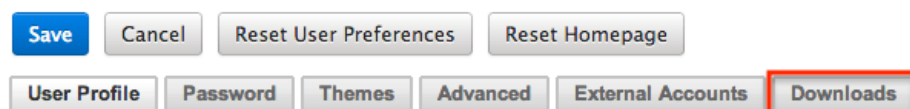

- **Lead Conversion Options** : Select an option from the dropdown menu to determine the handling of related activity records (e.g. calls, tasks, etc.) during lead conversion. For more information, please refer to the [Leads](#)

documentation in the Application Guide.

- **Move** : This option moves all of the lead's activities to the contact record created during conversion.
- **Do Nothing** : This option does not alter the lead's activities during conversion. The activities remain related only to the lead. This is the default setting.
- **Display actions within menus** : Select to display detail view and subpanel actions within a dropdown menu. If disabled, the actions will display as separate buttons.
 - **Note**: Only applies to Legacy modules.
- **Enable additional login screen content** : This option controls the visibility of the background image and notifications from SugarCRM that show on the Sugar login screen. Disable this option to prevent the background image and additional information from displaying.
- **Collapse all subpanels and disable sticky feature** : Select this option to collapse all subpanels in the record view by default and disable automatically expanding previously-expanded subpanels in order to improve performance. Once enabled, users wishing to view subpanel data will need to expand the subpanel each time they return to a module.
 - **Note**: Only applies to Sidecar modules.
- **Prevent user customizable subpanel layout** : Select this option to prevent users from dragging and dropping subpanels to a different location in the detail view layout.
 - **Note**: Only applies to Legacy modules.

Proxy Settings

Proxy servers redirect Internet traffic coming from and to the server running Sugar. If you are using a proxy server, you will need to enter proxy information into the system settings to allow the Sugar instance to communicate with the internet. This is necessary to allow the system licensing to validate and update. For more information on system licenses, please refer to the [License Management](#) section of the Sugar Connect documentation in the administration guide.

Note: Proxy settings should not be used for instances hosted on Sugar's cloud service.

Use the following settings to configure proxy settings:

- **Use Proxy Server?** : Select this option to use a proxy server and to reveal the following fields.
- **Proxy Host** : The host name or IP address of the proxy server to use.
- **Port** : The communication port of the proxy server.
- **Authentication?** : Select this option if the proxy server requires authentication and to reveal the following fields.

- **User Name** : The user name to authenticate to the proxy server.
- **Password** : The password to authenticate to the proxy server.

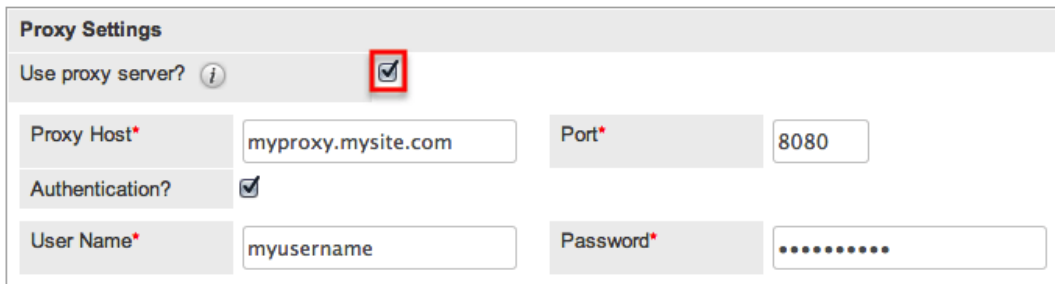

The image shows a 'Proxy Settings' form. At the top, there is a section titled 'Use proxy server?' with an information icon and a checked checkbox, which is highlighted with a red square. Below this, there are two rows of input fields. The first row has 'Proxy Host*' with the value 'myproxy.mysite.com' and 'Port*' with the value '8080'. The second row has 'Authentication?' with a checked checkbox and 'User Name*' with the value 'myusername'. The 'Password*' field is masked with dots. The 'Use proxy server?' checkbox and the 'Authentication?' checkbox are both highlighted with red squares.

Customer Self-Service Portal

The Customer Self-Service Portal provides an external-facing website for your customers to view Cases, Bugs, Knowledge Base articles and other data in Sugar. Select the checkbox next to "Enable Portal User Management" to enable the portal.

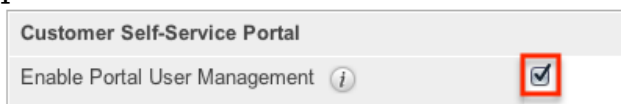

The image shows a 'Customer Self-Service Portal' settings section. It contains a single checkbox labeled 'Enable Portal User Management' with an information icon to its right. The checkbox is checked and highlighted with a red square.

This setting can also be enabled or disabled via Admin > Sugar Portal. For more information on configuring the portal, please refer to the [Sugar Portal](#) documentation. For more information on the Customer Self-Service Portal, please refer to the [Portal User Guide](#).

SkypeOut

SkypeOut takes any stock or custom field that has a type of Phone and makes it a link that launches Skype to call the phone number. The phone number must be formatted properly to use this feature. It must be "+" "The Country Code" "The Number" (e.g., +1 (555) 555-1234). Select "Enable SkypeOut integration" to enable this feature.

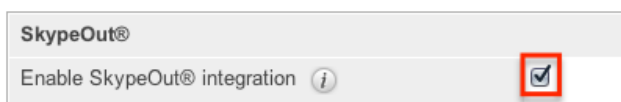

The image shows a 'SkypeOut®' settings section. It contains a single checkbox labeled 'Enable SkypeOut® integration' with an information icon to its right. The checkbox is checked and highlighted with a red square.

Preview Pane Settings

The preview edit feature allows users to edit records directly from the intelligence

pane on list views. Please note that the "Enable edit in Preview pane" setting is enabled by default, but administrators can disable the preview edit feature based on their organization's needs by removing the checkmark from the box. For more information on using this feature, please refer to the [User Interface](#) page in the Application Guide.

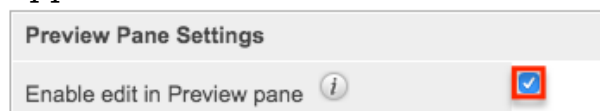

Activity Streams

Sugar's [activity streams](#) are disabled by default, but administrators can globally enable the functionality based on their organization's needs. To enable the activity stream in Sugar, simply place a check in the Enable Activity Streams box. When the feature is enabled, record posts will be generated in the system when performing actions such as creating records, updating records, linking records, unlinking records, etc. In addition, users will be able to access activity streams from anywhere within Sugar including via the home page, My Activity Stream dashlet, module's list view, etc. Please note that when the activity stream is disabled, Sugar will display a message in each of these locations indicating that the activity stream is not enabled. For the intelligence pane, the record's related activity stream posts will not appear.

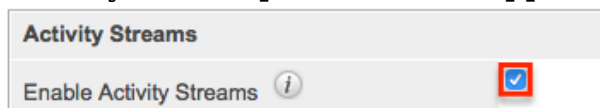

SugarBPM™

The SugarBPM™ panel contains the following configurations for the visual process designer and the SugarBPM engine:

- **Auto-save process definitions** : In the visual designer, process definitions are auto-saved every 30 seconds by default. This setting allows you to adjust the time interval in 30-second increments up to 5 minutes. To disable the auto-save feature, select "Never".
- **Auto-validate process definitions on auto-save** : Enabled by default, this option lets you decide whether Sugar should validate the open process definition's design each time the auto-save function runs. If auto-save is disabled, then enabling this feature will have no effect.
- **Auto-validate process definitions on import** : Enabled by default, this option lets you decide whether Sugar should automatically validate process definition designs when they are imported as .bpm files.

-
- **Error Number of Cycles** : Specify how many times a process can loop before the system stops the process definition. By default, this is set to 10. Please note that increasing the number of cycles could negatively affect performance.

Comment Log Settings

The Comment Log Settings panel contains a field that allows admins to configure the maximum number of characters shown per comment log entry. If an entry is longer than this value, it is truncated with a "Show more..." link to display the full text. Once the entry is expanded, a "Show less..." link is displayed to collapse the text so that only the configured number of characters are shown again. The default value is 500 characters.

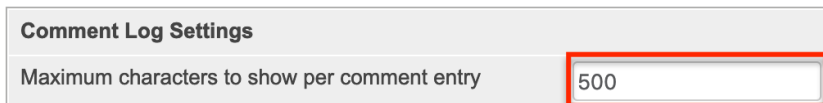

The screenshot shows a configuration panel titled "Comment Log Settings". Inside the panel, there is a label "Maximum characters to show per comment entry" followed by a text input field containing the number "500". The input field is highlighted with a red rectangular border.

Advanced

The Advanced panel consists of the following group of settings for advanced configuration of Sugar:

- **Validate user IP address** : Select this option to validate user's IP address while accessing Sugar. If the IP address of a user changes in mid-session, Sugar will log them out and force them to log back in for security reasons.
 - **Note:** Some high-availability systems, VPNs, and switching Wi-Fi and wired connections may change IP addresses and thus cause your users to be logged out when they have not changed their configuration.
- **Log slow queries** : Select this option to log queries that take longer than the slow query time threshold. This is useful for performance debugging.
 - **Note:** There is an inherent overhead to logging slow queries. If the threshold is set too low, it may cause performance issues.
- **Maximum upload size** : Specifies the maximum file size in bytes that is allowed to be uploaded to Sugar. This setting affects images, import files, and module uploads.
 - **Note:** The file upload size is also dependent on the php.ini `upload_max_filesize` and `post_max_size` directives. This admin setting will not affect the maximum cumulative file size for email attachments, which is set to 10MB per message via the

max_aggregate_email_attachments_bytes configuration attribute.

- **Portal Session Timeout** : The maximum time in seconds of inactivity for a Sugar Portal session. The session will timeout and the customer will be logged out when the time limit is reached with no activity.
Note: This value is only used for legacy versions of Sugar Portal available in 6.5 and older.
- **vCal Updates Time Period** : Determines the number of months the Free/Busy data is published to vCal. Specify the number of months in advance of the current date that Free/Busy information for calls and meetings to be published. To turn Free/Busy publishing off, enter "0". The maximum is 12 months.
- **Log memory usage** : Select this option to log memory usage per action performed in Sugar. The data will be stored in the ./memory_usage.log file.
- **Slow query time threshold (msec)** : Specify a threshold in milliseconds to begin logging slow queries at. If "Log slow queries" is selected, queries that take longer than the threshold to process will be logged. If you have enabled the Tracker Queries option on the [Tracker](#) page, you can run the pre-defined Slow Queries report to view slow queries.
- **Display stack trace of errors** : Select this option to display where errors occur in the application's stack trace. This option is for debugging purposes and should not be left on in a production instance.
- **Developer Mode** : Select this option to disable caching to immediately view changes made to language, vardefs, and template files. This option is for debugging purposes and should not be left on in a production instance.
- **Import - Maximum Number of Rows** : Specify how many rows are allowed within import files. If the number of rows in an import file exceeds this number, the user will be alerted. If no number or zero is entered, an unlimited number of rows are allowed.
 - **Note:** Header rows count towards the total number of rows in the import file.
- **Prevent private team names from inheriting the user's name fields** : Select this option if private team names may be different from the user's first and last name. By default, Sugar will update a private team name to [Firstname Lastname] any time the corresponding user's profile is edited and re-saved, even if the change was not made to the user's first or last name. Enable this option to ensure that edited private team names do not revert to the system default.

Logger Settings

Sugar comes with a built-in logging system to log information or errors that occur in the application. By default, the logs are written to sugarcrm.log in the Sugar root directory. If a problem arises, you can refer to the log file for information that may help in troubleshooting the issue. The Logger Settings panel consists of a

group of settings that affect the Sugar logs. Please note that SugarCloud customers can generate PHP error logs and access logs via the [SugarCloud Insights](#) page.

Note: The Logger Settings panel is hidden for instances on Sugar's cloud service. Should you require a log level to be temporarily changed on a SugarCloud production environment, you must open a [support case](#). For more information about default configuration settings for Sugar's cloud environments, please refer to the [SugarCloud Policy Guide](#).

Use the following settings to configure the different aspects of Sugar logging:

- **Log File Name** : Specify a name for the log file. Defaults to sugarcrm.
- **Maximum log size** : Specify the maximum size of the log file in megabytes (MB). The default is 10MB. Once a log file reaches the specified size it is renamed to have an incrementing number and a new file will be created to contain new logs.
- **Log Level** : Select the event level that you want to capture in the log file. The levels are listed below in order of the most log records to the least. The default level is fatal. When specifying a logging level, the system will create log files for the specified level as well as higher levels. For example, if you select "error", the system creates log files for "error", "fatal", and "security". Please note that there is an inherent overhead to logging. If the log level is set too high, it may cause performance issues. The "info" and "debug" settings are not recommended for continuous use in a production environment.
 - **debug** : Logs events that help debug the application
 - **info** : Logs informational messages
 - **warn** : Logs potentially harmful events
 - **error** : Logs error events in the application
 - **fatal** : Logs severe error events that cause the application to abort
 - **security** : Logs events that may compromise the security of the application
 - **off** : The logger will not log any events
- **Extension** : Specify the file extension for the log file. Defaults to .log.
- **Default date format** : The date format for the log file. This format must be supported by [strftime](#). Defaults to %c.
- **Maximum number of logs (before rolling)** : The maximum number of log files to save. When the number of log files exceeds this limit, Sugar deletes the log file that was created first. Defaults to 10.
- **Append after filename** : Select a time period from the dropdown list to append to the file name (None, Month_Year, Day_Month, Month_Day_Year). This makes it easier to identify the log that you want to view.

View Log

The Sugar log is stored in the root directory of Sugar and is accessible from the operating system. Administrators who do not have access to the operating system running Sugar do have the ability to view the log through Sugar. Navigate to Admin > System Settings and find the "View Log" link at the bottom of the screen:

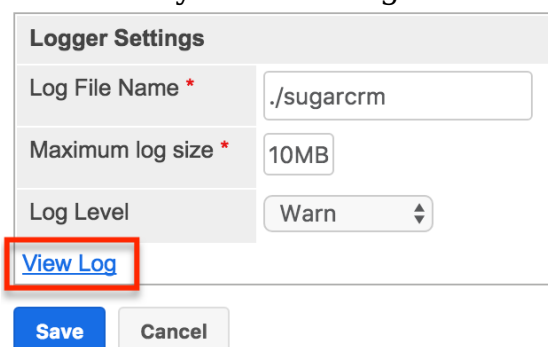

Logger Settings

Log File Name *

Maximum log size *

Log Level

[View Log](#)

This opens the log viewer for the current log file. You have the following options for navigating the log file:

- **All** : Select this option to view the entire log.
- **Mark Point** : Select this option to mark a starting point in the current log file.
- **Refresh From Mark** : Select this option to view any entries made in the log after the most recent mark.
- **Next** : Select this option to view new entries in the current log file.

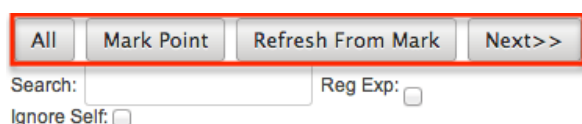

Search: Reg Exp:

Ignore Self:

A common method for utilizing these options to debug a problem would be to click "Mark Point", perform the action causing problems, and then select "Refresh From Mark" to see any log entries caused by the action being debugged.

You also have the ability to search within the log file for keywords. To perform a search, simply enter a keyword into the search box and press Enter on your keyboard to execute the search.

Locale

Locale allows administrators to configure localization settings to your organization's specifications. Some of the settings specified here can be overridden by user-level personalizations such as date and time formats on the User Preferences page. The locale settings are split across a few different panels of related information. Change the values in any of the panels and click "Save" to

preserve your changes.

Locale



Save Cancel

User Interface

Date Format: 12/23/2010

Language: English (US)

Name Format: Dr. David Livingstone

User Interface

The User Interface panel consists of a group of locale settings that affect the interface of Sugar. Use the following settings to configure the different aspects of the interface:

- **Date Format** : Select a format from the dropdown for displaying the date throughout the application.
- **Language** : Select a default language from the dropdown for use throughout the application. Users can select a different language from the login page. For more information regarding enabling or disabling languages, please refer to the [Languages](#) section.
- **Name Format** : Select a format from the dropdown for displaying people names throughout the application. You can specify any combination of salutation, first name, and last name.
- **Time Format** : Select a format from the dropdown for displaying the time throughout the application.

Users have the ability to override the default date, time, and name formats through their user profiles. For more information on how to set locale settings per user, please refer to the [Locale Settings](#) section of the Getting Started documentation in the Application guide.

System Currency

The System Currency panel consists of a group of currency settings that affect the interface of Sugar. The system currency is displayed in addition to a record's original currency in most places across Sugar. The value is displayed in the system currency with a grey box containing the value in the record's currency next to it. However, the system currency can be overridden by the user's preferred currency if "Show Preferred Currency" is enabled in their [Locale Settings](#) and the user's

preferred currency is different from the system currency. Use the following settings to configure the different currency options:

- **Currency** : The name of the default currency your organization uses to conduct business.
- **ISO 4217 Currency Code** : The ISO code for the currency.
 - **Note**: This setting must be populated in order for the currency (e.g. EUR) to display in the Quotes detail view.
- **Decimal Symbol** : The default decimal symbol.
- **Currency Symbol** : The default symbol for the currency.
- **1000s Separator** : The default delimiter to separate thousands.

Users have the ability to override the currency defaults through their user profiles. For more information on how to set currency settings per user, please refer to the [Locale Settings](#) section of the Getting Started documentation in the Application guide.

Export Settings

The Export Settings panel consists of a group of export settings that affect different aspects of exporting in Sugar. Use the following settings to configure the different export options:

- **Export Delimiter** : The delimiter used to separate fields while exporting data. Defaults to a comma.
- **Disable export** : Select this option to disable the export option for all users, including administrators.
- **Default Character Set for Import and Export** : Select a default character set from the dropdown that handles the expected characters in an import and export. Defaults to UTF-8.
- **Admin export only** : Select this option to disable the export option for standard users, administrators will be allowed to export.

Users have the ability to override the default export delimiter and character set through their user profiles. For more information on how to set export settings per user, please refer to the [User Preferences](#) section of the Getting Started documentation in the Application guide.

Note: Locales that use character encoding other than UTF-8 must specify the appropriate character set.

Database Collation

The Database Collation panel only shows if running on a MySQL database and contains an option to change the collation of the connection Sugar makes to the database. Select the desired collation from the dropdown. Defaults to utf8_general_ci.

Note: Changing this setting will not change existing tables, but only new tables going forward. If this setting does not match the collation of the current tables in the database then the database will return errors when accessing those tables.

Currencies

Currencies allow administrators to create and manage currencies and exchange rates in Sugar. The defined currencies in the system can be viewed in the Currencies list view which can be accessed by selecting "Currencies" under the System panel of the Admin page. Please note that the default system currency (e.g. USD) will always display first in the Currencies list view. The default system currency cannot be edited via the Currencies module and will need to be edited via Admin > Locale. For more information on configuring the default currency, please refer to the [System Currency](#) section.

Note: For additional information regarding the basics of performing common tasks or operations (e.g. creating records, editing records, deleting records) in the application, please refer to the [User Interface](#) documentation in the Application Guide.

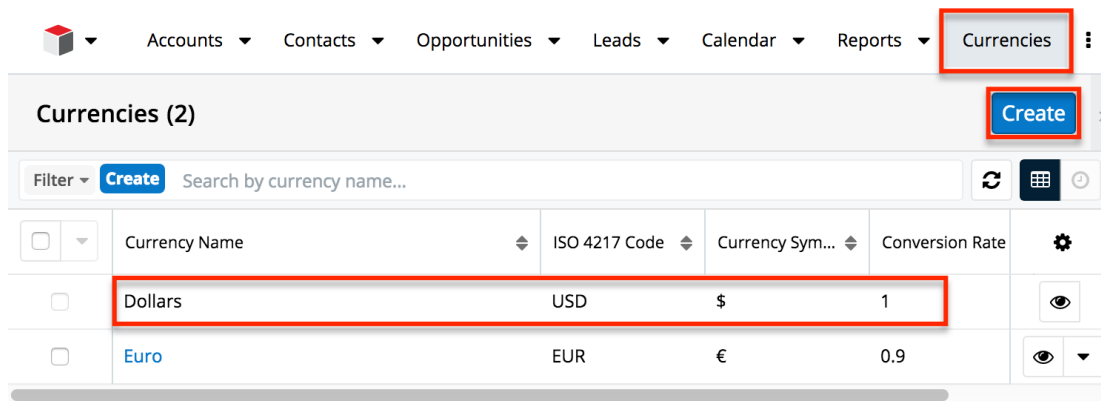

The screenshot shows the SugarCRM interface for the Currencies module. At the top, a navigation bar includes 'Accounts', 'Contacts', 'Opportunities', 'Leads', 'Calendar', 'Reports', and 'Currencies' (highlighted with a red box). Below this, the 'Currencies (2)' header is visible, with a 'Create' button (also highlighted with a red box) on the right. A search bar with the placeholder 'Search by currency name...' and a 'Filter' dropdown is present. The main content is a table with the following columns: 'Currency Name', 'ISO 4217 Code', 'Currency Sym...', and 'Conversion Rate'. The table contains two rows: 'Dollars' (USD, \$, 1) and 'Euro' (EUR, €, 0.9). The 'Dollars' row is highlighted with a red border.

<input type="checkbox"/>	Currency Name	ISO 4217 Code	Currency Sym...	Conversion Rate	
<input type="checkbox"/>	Dollars	USD	\$	1	
<input type="checkbox"/>	Euro	EUR	€	0.9	

To create a new currency in the system, simply click the Create button on the upper right of the Currencies list view. Enter appropriate values for the fields in the record view layout then click "Save".

Accounts ▾
Contacts ▾
Opportunities ▾
Leads ▾
Currencies
⋮

Cu

Currency Name

Cancel
Save
»

ISO 4217 Code

Currency Symbol

Conversion Rate

Status

Active
▾

Field	Description
Currency Name	The name or designation of the currency Note: The currency name auto-populates based on the value entered in the ISO 4217 Code field.
ISO 4217 Code	The ISO code for the currency Note: This setting must be populated in order for the currency (e.g. EUR) to display in the Quotes module.
Currency Symbol	The default symbol for the currency Note: The currency symbol auto-populates based on the value entered in the ISO 4217 Code field.
Conversion Rate	The conversion rate to get to this currency from the system's default currency.
Status	The current status of the currency (e.g. Active, Inactive) Note: Selecting "Inactive" will remove this currency from currency fields throughout the application.

Updating Conversion Rates

Users may use the currencies defined in Admin > Currencies when populating any currency amount field in stock or custom modules. When doing so, the exchange rate for the selected currency is stored on the record itself. The conversion rate stored on each record will update to match the current rate specified in Admin > Currencies under the following scenarios:

- The record undergoes a save event (e.g., mass update, manual save, etc.) and the record's currency has a different conversion rate defined in Admin > Currencies than is currently saved in the opportunity.
- An administrator updates the currency exchange rate under Admin > Currencies. This will trigger a scheduled job which updates all records saved with that currency to the new rate.

To keep closed-business amounts historically accurate, opportunity and quote records will not update if they are in a closed status. For more information about updating opportunity currency rates, please refer to the [Opportunities](#) documentation in the application guide. For more information about updating quote currency rates, please refer to the [Quotes](#) documentation in the application guide.

Languages

The Languages section allows administrators to configure which languages are available for users to log in with. To disable a language, simply drag the language from the Enabled Languages panel to the Disabled Languages panel and click "Save".

Languages

Drag and Drop the names of the languages below to enable and disable them.

The screenshot shows a web interface for configuring languages. At the top, there are two buttons: "Save" (highlighted with a red box) and "Cancel". Below this is a table with two columns: "Enabled Languages" and "Disabled Languages". The "Enabled Languages" column contains a list of languages: English (US), Български, Český, Dansk, Deutsch, Ελληνικά, Español (highlighted with a red box), Français, עברית, Magyar, Italiano, and Lietuvių. A red arrow points from the "Español" row in the "Enabled Languages" column to the "Disabled Languages" column. At the bottom, there are two buttons: "Save" and "Cancel".

Any languages in the Disabled Languages section will not be in the Languages dropdown while logging in.

Search

Global search allows users to search for information across their entire Sugar database as opposed to restricting search within a specific module. For more information on how to use global search, please refer to the [Global Search](#) section of the Search documentation in the Application guide. The Search administration settings allow administrators to configure, enable, and index full-text search. Global searches in the desktop application and Sugar Mobile will be returned by [full-text search](#).

Configuring Full-Text Search

Sugar's global search is enabled with full-text searching abilities that use the ElasticSearch engine. Full-text search allows users to search throughout various fields and modules for an enhanced search experience. In order for results to return for a particular module, the module must be enabled on the Full-Text Search Configuration page. To enable or disable a stock or custom module for global search, simply drag and drop the module between the Enabled Modules or Disabled Modules column and click "Save".

Full Text Search

Select the module(s) that users will be able to search against using the Global Search. Perform a full system index after enabling modules for the Global Search. To enable module fields for full text searching, use [Studio](#).

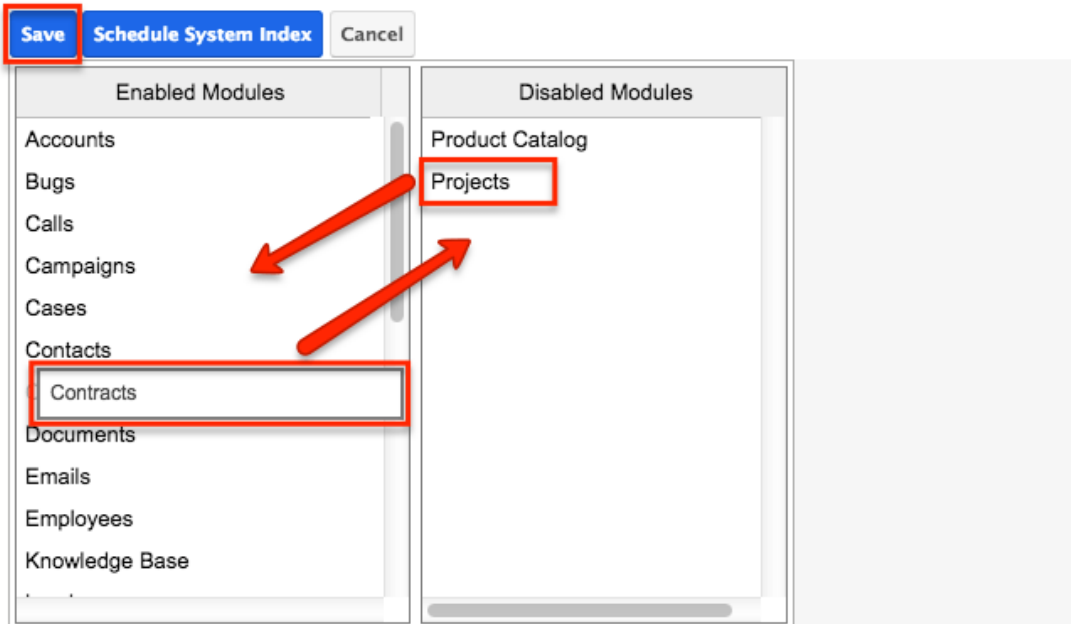

Disabled modules will not be included in the global search results nor available to select in the Modules list on the Global Search bar in the desktop application. For more information on filtering the global search by modules, please refer to the [Filtering by Module](#) section of the Search documentation in the Application guide.

After enabling modules for Global Search, a full system index must be performed in order for the module to appear in the search results. For more information on

performing a system index, please refer to the [Indexing Full-Text Search](#) section of this documentation.

Individual module fields must be enabled for full-text search in the field attributes via Studio > {Module Name} > Fields > {Field Name}. For more information, please refer to the [Studio](#) documentation.

Note: Only modules enabled for Full-Text Search can be referenced in user posts on the activity stream. For more information on referencing record's in posts, please refer to the [Activity Stream](#) documentation in the Application guide.

Activating Full-Text Search

Sugar's global search is enabled with full-text searching abilities using the ElasticSearch engine. Full-text search (FTS) allows users to search throughout various fields and modules for an enhanced search experience. Please note that ElasticSearch is required to be set up when installing Sugar for on-site instances and it is automatically enabled by default for instances on Sugar's cloud service.

Use the following steps to configure full-text search:

1. The ElasticSearch server is selected by default for the System Type field.
 - **Note:** For more information on ElasticSearch, please refer to www.elasticsearch.org.

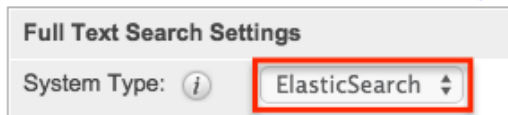

2. Enter the host name or IP address of the full-text search engine.
 - **Note:** Defaults to "localhost" assuming you are running the search engine on the same server as Sugar.
3. Enter the port number for Sugar to connect to the search engine.
 - **Note:** Defaults to "9200", which is ElasticSearch's default port number.
4. Click "Test" to verify that the settings are entered correctly and confirm that Sugar connects to the search engine successfully.

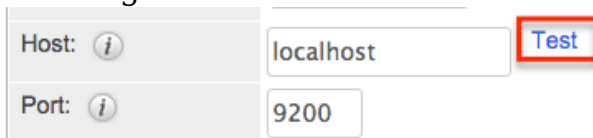

A pop-up message will confirm if the connection was successful or not.

5. If the connection was successful, click "Save" to preserve your changes.

Each enabled module has a set of fields that are enabled for full-text searching by default. Administrators can enable or disable specific fields for full-text search via Admin > Studio. For more information on how to enable or disable fields for full-text search, please refer to the [Studio](#) documentation.

Note: Once a new module or field is added to full-text search, you must perform a system index in order for that field or module to be included in the full-text search results.

Indexing Full-Text Search

Full-text search relies on an index of the records and data to be able to quickly locate results. After enabling full-text search, or enabling a module or field, you should perform a full index of your system.

Note: System performance can be affected while the index is being performed. It is recommended to run a system index during low usage or off-hours.

Use the following steps to perform a full system index:

1. Click "Schedule System Index".

2. A pop-up message will display warning of potential performance issues during the index. Click "OK" to proceed.
3. The list of available full-text search modules will display. Simply select one or more module(s) to perform the index. You may also select "All" to index all full-text search enabled modules.

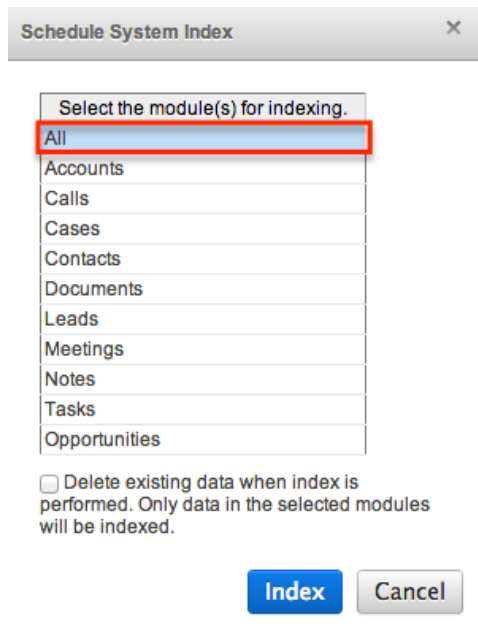

4. Select the checkbox to delete the current index data before the index operation runs. If this is the first index being performed on the system, you do not need to select this option. If you have added fields to a module's index, then this checkbox should be selected or the new field may not show in the results.
5. Click the Index button to schedule the index.
6. The next time the scheduler runs, it will rebuild the index based on the selected options. For more information on schedulers, please refer to the [Schedulers](#) documentation.

Note: The time and resources required to perform an index are directly proportional to the number of modules selected for the indexing. It is recommended that you choose only the modules that require indexing and perform the index during low usage or off-hours.

Configuring Legacy Global Search

Legacy global search has been deprecated and is no longer applicable to any parts of Sugar. To enable modules for global search in the desktop application or Sugar Mobile, use the [Full-Text Search Configuration](#) instead.





Connectors

The connector settings page allows administrators to configure and manage the various types of connectors to external data sources that integrate with Sugar. A number of different connectors (e.g. Citrix GoToMeeting) come out-of-the-box with Sugar and are enabled by default to allow users to easily view external data via

their instance.

Please note that connectors can be disabled and configured accordingly via Admin > Connectors. Developers in your organization can also create connectors to other data sources, which can be uploaded via Module Loader. For more information on how to upload and install packages in Sugar, please refer to the [Module Loader](#) documentation. You can also search for other available connectors via Sugar Exchange (<http://www.sugarexchange.sugarcrm.com>).

Connector Settings

	Set Connector Properties Configure the properties for each connector, including URLs and API keys.		Map Connector Fields Map connector fields to module fields in order to determine what connector data can be viewed and merged into the module records.
	Enable Connectors Select which modules are enabled for each connector.		Manage Connector Search Select the connector fields to use to search for data for each module.

Setting Connector Properties

Many connectors use web services and require certain connector properties (e.g. API Key, API Secret) to be configured prior to use. To configure the connector properties, simply click the Set Connector Properties button on the Connector Settings page.

	Set Connector Properties Configure the properties for each connector, including URLs and API keys.
---	--

The Set Connector Properties page displays a tab for each connector that must be configured in order to use in Sugar. The tabs will include the necessary steps or a link for you to obtain the information (e.g. API Key, API Secret) needed to set up the connector. Once the necessary information has been entered, click "Save" to preserve your settings.

The following connectors and their properties are available to configure:

Connector	Property	Description
Google	Client ID	The Client ID provided by Google
	Client secret	The Client secret provided by Google

GoToMeeting	Consumer Key	The Consumer Key provided by GoToMeeting
IBM SmartCloud	OAuth Consumer Key	The OAuth Consumer Key provided by IBM
	OAuth Consumer Secret	The OAuth Consumer Secret provided by IBM

Please note that Sugar's WebEx integration is configured via the External Accounts tab of the user's profile. Since WebEx does not have global properties to configure, it will not appear on the Set Connector Properties page.

For more information on configuring the WebEx application, please refer to the [Getting Started](#) documentation in the Application Guide.

Enabling Connectors

In order to utilize the connectors in Sugar, administrators should ensure that they are enabled properly. Please note that certain connectors are enabled for the entire application while some allow you to enable specific modules for the connector. Simply click the Enable Connectors button on the Connector Settings page to configure the modules that should be enabled for certain connectors.



Enable Connectors
Select which modules are enabled for each connector.

The Enable Connectors page will display a tab for each connector that is available in your Sugar instance. Connectors, where you can enable specific modules for, will display the Enabled and Disabled columns where you can drag and drop the desired module from the Disabled column to the Enabled column. Please note that you can enable the connector for any modules (e.g. Accounts, Contacts) that have a standard record view (for Sidecar modules) or detail view (for Legacy modules) layout in Sugar.

Mapping Connector Fields

Some connectors query external services based on fields in Sugar. These mappings can be customized to use different fields based on your organization's needs. To configure the field mappings, simply click the Map Connector Fields button on the Connector Settings page.



Map Connector Fields
Map connector fields to module fields in order to determine what connector data can be viewed and merged into the module records.

The Map Connector Fields page has a tab for each connector that has field mappings available. Each of the enabled module(s) will display the connector fields and will need to have the corresponding Sugar field selected from the dropdown list. If the connector is enabled for multiple modules, be sure to select the proper fields for each module. Once the field mapping is set up properly, click "Save" to preserve your changes.

Please note that the connector fields may not always match up with a stock field in Sugar. If you wish to capture and map certain fields from the connector to Sugar, you will need to create new fields via Admin > Studio. For more information on how to create fields in Studio, please refer to the [Studio](#) documentation.

Managing Connector Search

Connectors that have multiple fields for mapping need to specify which fields are to be used when searching for data in the module. To designate the connector fields for search, click the Manage Connector Search button on the Connector Settings page. Please note that there are no connectors that come out-of-the-box with Sugar that have search fields defined, so no connectors will be available to configure on this page.



Manage Connector Search
Select the connector fields to use to search for data for each module.

The Manage Connector Search page will normally display a tab for every connector that needs connector fields defined for search. The available search fields are limited to the input parameters of the connector being used. To enable a field for search, simply drag and drop the desired field from the Available column to the Default column. Once the necessary field(s) have been selected, click "Save" to preserve your changes.

OAuth Keys

OAuth is an open standard for authorization that enables users to share private resources stored on one site with another site without divulging personal credentials such as user name and password. OAuth works with a public consumer key and a private consumer key. Together, these keys identify which application connects to the service. It is the choice of the Sugar administrator to decide how many different keys to have and whom to give them to.

OAuth Keys Fields

The OAuth Keys module contains a number of stock fields that come out-of-the-box with Sugar. The below definitions are suggested meanings for the fields, but the fields can be leveraged differently to best meet your organization's needs.

Field	Description
Consumer Key Name	The name or designation of the OAuth Key.
Consumer Key	Public key. A user name is a suitable consumer key value.
Consumer Secret	Private key. A password is a suitable consumer secret value. Note: The private key is not sent when making a connection.
OAuth Version	The version of the OAuth protocol/framework to use. (OAuth 1.0, OAuth 2.0)
Description	A description or other information about the OAuth key.

OAuth Keys Module Tab

The OAuth Keys module tab appears on the navigation bar once you select "OAuth Keys" from the Administration page. Once in the OAuth Keys list view, you can click the triangle in the OAuth Keys module tab to display the Actions and Recently Viewed menus. The Actions menu allows you to perform important actions within the module. The [Recently Viewed menu](#) displays the list of OAuth keys you last viewed in the module.

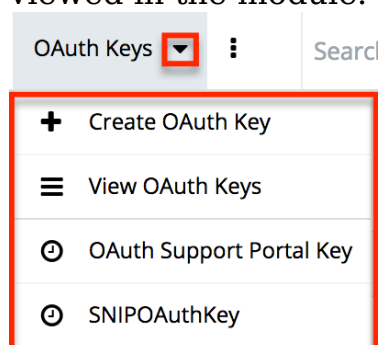

The Actions menu allows you to perform the following operations:

Menu Item	Description
Create OAuth Key	Opens the edit view layout to create a new OAuth Key

[View OAuth Keys](#)

Opens the list view layout to search and display OAuth Keys

Creating OAuth Keys

There are various methods for creating OAuth keys in Sugar including via the OAuth Keys module and via duplication. The full edit view layout opens when creating the OAuth keys directly from the OAuth menu and includes all of the relevant fields for your organization's OAuth keys. The quick-create form is a shortened version of the OAuth Keys edit view and typically contains fewer fields.

Creating Via OAuth Keys Module

One of the most common methods of OAuth key creation is via the Create OAuth Key option in the OAuth Keys module tab. This opens up the edit view layout which allows you to enter all the relevant information for the OAuth key.

Use the following steps to create an OAuth key via the OAuth Keys module:

1. Navigate to Admin > OAuth Keys.
2. Click the triangle in the OAuth Keys module tab and select "Create OAuth Key".

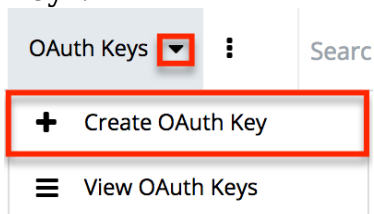

3. Enter appropriate values for the [Fields](#) in the edit view layout. All required fields are marked with a red asterisk and must be completed prior to saving.
4. Once the necessary information is entered, click "Save".

Create

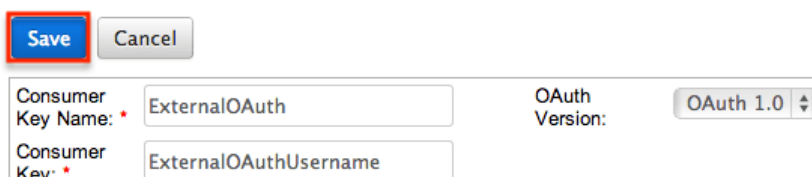
A screenshot of the OAuth key creation form. The 'Save' button is highlighted with a red box. The form contains the following fields: 'Consumer Key Name' with the value 'ExternalOAuth', 'Consumer Key' with the value 'ExternalOAuthUsername', and 'OAuth Version' with a dropdown menu set to 'OAuth 1.0'. There are also 'Create' and 'Cancel' buttons at the top.

Creating Via Duplication

You can also create a new OAuth key by duplicating an existing record. The duplicate option is useful if the key you are creating has similar information to an existing OAuth key.

Note: The system-generated OAuth Support Portal Key cannot be duplicated.

Use the following steps to create an OAuth key by duplicating an existing record:

1. Navigate to an OAuth key record's detail view.
2. Select "Duplicate" from the Actions menu.

ExternalOAuth

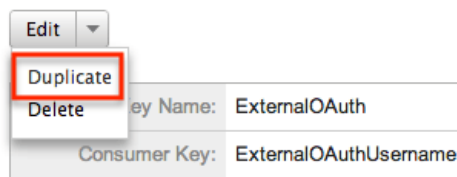

3. The displayed edit view is pre-populated with the original key's values. Update the necessary fields, then click "Save".

Create

A screenshot of the OAuth key edit view. At the top left, there are 'Save' and 'Cancel' buttons. The 'Save' button is highlighted with a red box. Below the buttons, the 'Consumer Key Name' field is pre-populated with 'ExternalOAuth_New'. The 'OAuth Version' is 'OAuth 1.0'. The 'Consumer Key' field is pre-populated with 'ExternalOAuthUsername'.

Note: When duplicating, the Consumer Key and OAuth Version are not modifiable.

Viewing OAuth Keys

There are various options available for viewing OAuth key records in Sugar including via OAuth Keys list view, OAuth Keys detail view, and OAuth Recently Viewed menu.

Viewing Via List View

The OAuth Keys list view displays all OAuth key records meeting the current search criteria. To access the list view, simply click the OAuth Keys module tab. While list view shows key OAuth key fields, you can click the key's name to open the record in detail view. For more information on viewing OAuth keys via list view, please refer to the [OAuth Keys List View](#) section.

Viewing Via Detail View

The OAuth Keys detail view displays thorough OAuth key information including all key fields followed by subpanels of the key's related records belonging to various modules. The detail view can be reached by clicking a key record's link from anywhere in the application including from the OAuth Keys list view. For more information on viewing OAuth keys via detail view, please refer to the [OAuth Keys Detail View](#) section.

Viewing Via Recently Viewed

As you work in the OAuth Keys module, Sugar will keep track of which OAuth key records you have recently viewed. Click the triangle in the [OAuth Keys module tab](#) to see a list of the 3 records you most recently viewed in the module. Clicking the record's name within the list will open it in detail view.

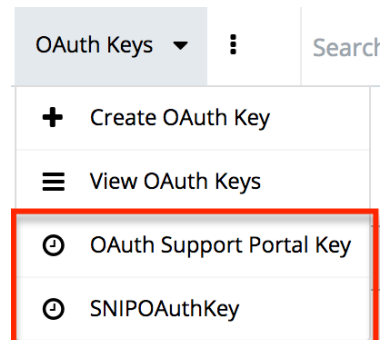

Searching OAuth Keys

The OAuth Keys list view includes a Basic and Advanced Search to help you locate records easily and effectively in a module-specific manner. Once the search is performed, the relevant results will be displayed in the OAuth Keys list view below.

Please note that Sugar automatically appends the wildcard character (%) to the end of your search phrase. This allows the system to retrieve all records that start with the keyword entered in the search. If you would like to broaden the search, you can use the wildcard at the beginning of your text as well (e.g., %services). This will pull up any record that has the word "services" in the name, regardless of how it starts or ends.

For more information on using the various search methods as well as how wildcards are used in the different methods, please refer to the [Search](#) documentation.

Basic Search

Basic search offers a few, commonly used fields for a simplified search experience. From the Basic Search panel, you can click "Advanced Search" to access additional search functionality as needed.

The buttons and checkboxes available in Basic Search panel have the following functions:

- **Search** : Click the Search button or press your Return/Enter key to perform the search.
- **Clear** : Click the Clear button to clear all criteria from the searchable fields.

OAuth Consumer Keys

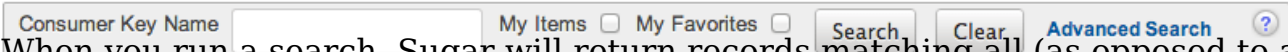

When you run a search, Sugar will return records matching all (as opposed to any) of the fields and checkboxes for which you have given values. Once the search is complete, the relevant results will populate in the list view below the search panel. To see all OAuth key records to which you have access, simply click "Clear" and then "Search" to perform a blank search with no filters.

Advanced Search

Advanced Search offers a more in-depth search experience than Basic Search including additional fields, layout options, and saved search capability. From the Advanced search panel, you can click "Basic Search" for simplified searching.

The buttons, checkboxes, and dropdowns available in Advanced Search have the following functions:

- **Search** : Click the Search button or press your Return/Enter key to perform the search.
- **Clear** : Click the Clear button to clear all criteria from the searchable fields.
- **Layout Options** : Use the expandable Layout Options section to configure your list view. For more information, please refer to the [Layout Options](#) section of the Search documentation.
- **Saved Searches** : Save, recall, update, and delete searches that you use often. For more information, please refer to the [Saved Search](#) section of the Search documentation.

When you run a search, Sugar will return records matching all (as opposed to any) of the fields for which you have given values. When searching by a multiselect or dropdown field (e.g., "Assigned to"), however, Sugar will return records matching any of these selections. Once the search completes, the relevant results will populate in the list view below the search panel. To see all OAuth key records to which you have access, simply click "Clear" and then "Search" to perform a blank search with no filters.

OAuth Keys List View

The OAuth Keys list view displays all OAuth key records meeting the current search criteria. You can view the basic details of each key within the field columns. You have the option to change what fields are displayed in list view by configuring your layout options in the OAuth Advanced Search. For more information on configuring your list view, please refer to the [Layout Options](#) section of the Search documentation.

Pagination

List view displays the current search results broken into pages that you can scroll through rather than displaying potentially thousands of rows at once. To the right just below the search panel, you can see which records of the total results set are currently being displayed. The two single-arrow Next and Previous buttons can be used to scroll through the records page-by-page. The two double-arrow First Page and Last Page buttons allow you to skip to the beginning or the end of your current results.

By default, Sugar displays 20 records per list view page, but administrators can change the number of records displayed via Admin > System Settings. For more information on changing the number of displayed records, please refer to the System Settings > User Interface section of this page.

Checkbox Selection

You can perform several actions on OAuth key records directly from the list view by first selecting the desired records. To select individual key records on the OAuth Keys list view, mark the checkbox on the left of each row. To select or deselect multiple key records on the list view, use the options in the checkbox dropdown menu:

- **Select This Page** : Selects all records shown on the current page of key results.
- **Select All** : Selects all records in the current search results across all pages of key results.
- **Deselect All** : Deselects all records that are currently selected.

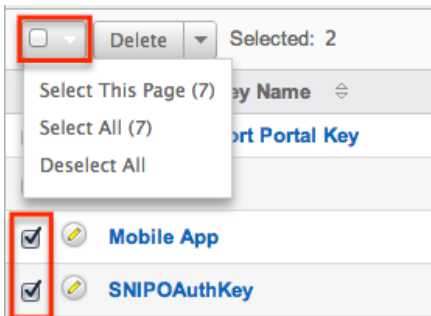

Actions Menu

The Actions menu to the right of the checkbox dropdown allows you to perform various actions on the currently selected records.

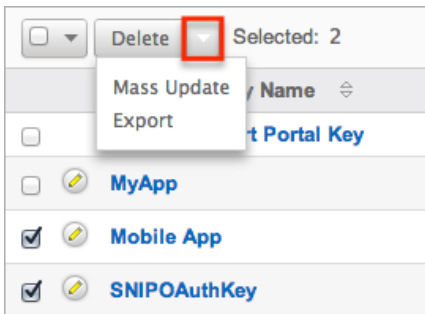

The options in the Actions menu allow you to perform the following operations:

Menu Item	Description
Delete	Delete one or more OAuth keys at a time
Mass Update	Mass update one or more OAuth keys at a time
Export	Export one or more OAuth keys to a CSV file

Column Sorting

List view provides the ability to sort all of the current search results by a field column in either ascending or descending order. To sort by a field or switch the sort direction, click the column header noting that the fields which allow sorting will have a pair of arrows. The list view may be sorted by only one column at a time. You can also set a default order-by column using the layout options in Advanced Search. For more information on setting a default column sort, please refer to the [Layout Options](#) section of the Search documentation.

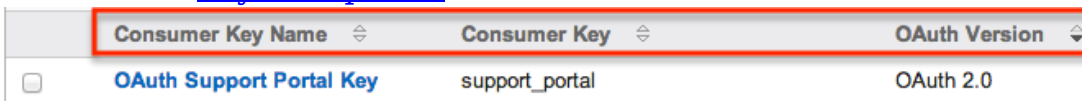

Consumer Key Name	Consumer Key	OAuth Version
<input type="checkbox"/> OAuth Support Portal Key	support_portal	OAuth 2.0

OAuth Keys Detail View

The OAuth Keys detail view displays thorough OAuth key information including all fields. You can also view a key's related tokens, which appear in a subpanel beneath the key fields. The detail view can be reached by clicking an OAuth key record's link from anywhere in the application including from the OAuth Keys list view.

Actions Menu

The Actions menu on the top left of each OAuth key's detail view allows you to perform various actions on the current record. Administrator users can change the action items to be displayed as separate buttons instead of a dropdown menu via Admin > System Settings. For more information on configuring the actions menu, please refer to the System Settings > User Interface section of this page.

ExternalOAuth

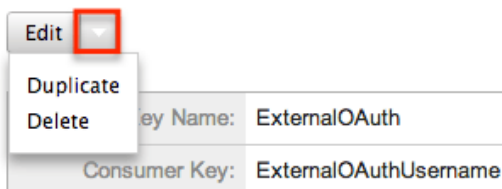

The options in the Actions menu allow you to perform the following operations:

Menu Item	Description
Edit	Edit this OAuth key

Duplicate	Duplicate this OAuth key
Delete	Delete this OAuth key

Next or Previous Record

On the upper right of the OAuth Keys detail view, there are two buttons that allow you to page through each OAuth key in the OAuth Keys list view's current search results. Clicking the Previous button displays the previous key of the current search results while clicking the Next button displays the next key of the current search results. The text in between shows which key result you are currently viewing within the total number of current results.

ExternalOAuth

The screenshot shows an 'Edit' button with a dropdown arrow on the left. To its right is a navigation control consisting of a left arrow, the text '(6 of 7)', and a right arrow, all enclosed in a red box. Below this is a metadata bar with two sections: 'Consumer Key Name: ExternalOAuth' and 'OAuth Version: OAuth 1.0'.

Tokens

Beneath an OAuth key record's fields is a subpanel containing related token records. Tokens are created when the user establishes an OAuth connection with the OAuth key pair. These are connections between the Sugar user, the OAuth keys, and the permissions to enable the external application to access data. Tokens created for each OAuth connection are listed in the Tokens subpanel of the corresponding OAuth Keys detail view page. The Tokens subpanel can be collapsed or expanded by clicking the double arrow to the left of the subpanel's name.

The screenshot shows a subpanel titled 'Tokens' with a double arrow icon to its left, highlighted with a red box. The subpanel contains a table with columns: ID, Status, Timestamp, and User. There are two rows of data. The second row has a 'delete' button to its right, which is highlighted with a red box. Above the table is a navigation control with a left arrow, the text '(1 - 2 of 2)', and a right arrow.

ID	Status	Timestamp	User	
dec6c86efd62	Request	05/07/2013 06:02pm	Will Westin	delete
3eb3f40415fc	Request	05/07/2013 06:03pm		delete

To delete a token from an OAuth key, choose "Delete" from the far right of the record's row.

Editing OAuth Keys

OAuth keys may be edited at any time to update or add information to the record.

You can make changes to existing key records via the OAuth Keys edit view and quick-create forms. Edit view is available within the OAuth Keys module and includes all of the key fields you should need.

Note: The system-generated OAuth Support Portal Key cannot be modified.

[ExternalOAuth](#) » Edit

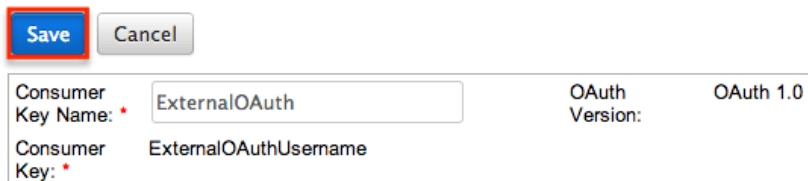

Consumer Key Name: *	<input type="text" value="ExternalOAuth"/>	OAuth Version:	OAuth 1.0
Consumer Key: *	<input type="text" value="ExternalOAuthUsername"/>		

Note: Consumer Key and OAuth Version fields cannot be edited after creation. If either of these fields needs to be changed, you must create a new OAuth key.

Editing Via Detail View

You can edit OAuth keys via the [Detail View](#) by clicking the Edit button on the upper left of the page. Once the edit view layout is open, update the necessary fields, then click "Save" to preserve your changes.

ExternalOAuth



Consumer Key Name:	ExternalOAuth
Consumer Key:	ExternalOAuthUsername

Editing Via List View

You can edit OAuth keys via the [List View](#) by clicking the Pencil icon to the left of each key's name. A pop-up window will open with the quick create form which is a shortened version of the edit view layout. Update the necessary fields, then click "Save" to preserve your changes.

Consumer Key Name	
<input type="checkbox"/>	OAuth Support Portal Key
<input type="checkbox"/>	 MyApp

Deleting OAuth Keys

If an OAuth key record is invalid or should no longer appear in your organization's Sugar instance, it may be deleted from either the OAuth Keys detail view or list view. Deleting via the detail view allows you to delete a single record while the list view allows for mass deleting multiple records at once.

Note: The system generated OAuth Support Portal Key should not be deleted.

Deleting Via Detail View

Use the following steps to delete an OAuth key record via the detail view:

1. Navigate to a key record's detail view.
2. Select "Delete" from the Actions menu.

ExternalOAuth

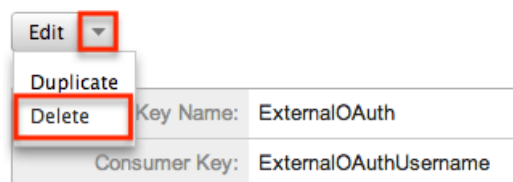

3. A pop-up message will display asking for confirmation. Click "Ok" to proceed.

Mass Deleting Via List View

Use the following steps to delete one or more OAuth key records via the list view:

1. Navigate to the OAuth Keys list view by clicking the OAuth Keys module tab.
2. Use the [Basic](#) or [Advanced Search](#) to find the key records you wish to delete.
3. Select the desired key records individually or using the [checkbox dropdown's](#) options.
4. Choose "Delete" from the Actions menu.

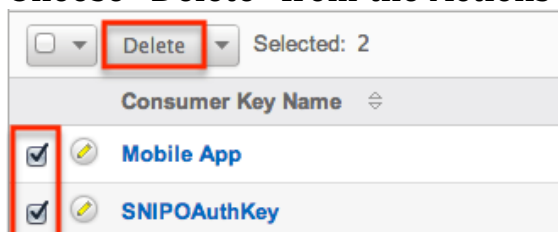

5. A pop-up message will display asking for confirmation. Click "Ok" to proceed.

Due to PHP memory limitations on the server, there may be occasions when the

application times out while deleting a large number of key records. If you encounter an error when performing this action, we recommend selecting the records in smaller batches.

Exporting OAuth Keys

Sugar's Export option allows users to download all fields for the selected OAuth keys to their computers as a .CSV (comma-separated values) file. This may be useful when needing to use OAuth data with other software such as Microsoft Excel. Due to PHP memory limitations on the server, there may be occasions when the application times out while exporting a large number of key records. If you encounter an error when performing this action, we recommend selecting the records in smaller batches.

OAuth keys may be exported from the OAuth Keys list view by selecting "Export" from the Actions menu.

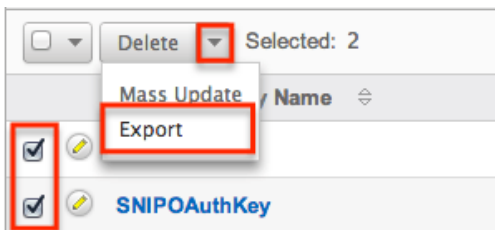

Mass Updating OAuth Keys

Mass Updating allows users to make the same change to multiple OAuth key records at once from the OAuth Keys list view. Due to the PHP memory limitations on the server, there may be occasions when the application times out while mass updating a large number of key records. If you encounter an error when performing this action, we recommend selecting the records in smaller batches.

Use the following steps to mass update OAuth key records from the list view:

1. Navigate to the OAuth Keys list view by clicking the OAuth Keys module tab.
2. Use the list view's Basic or Advanced Search to find the key that you wish to modify.
3. Select the desired keys individually or using the checkbox dropdown's options.
4. Choose "Mass Update" from the Actions menu.

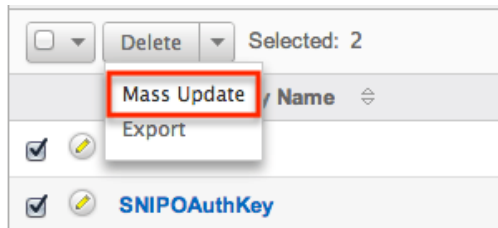

5. Scroll to the Mass Update panel and set values for the fields you wish to alter.

Mass Update

Assigned User Id	<input type="text"/>	Client Type	<input type="text" value="-none-"/>
------------------	----------------------	-------------	-------------------------------------

6. Click "Update" to save the changes to all of the currently selected key records.

Import Wizard

Import Wizard allows administrators to launch an import for any import enabled module without navigating to the module itself. After selecting "Import Wizard" from the Admin menu, you can select a module to perform an import on.

[Import](#) » Step 1: Select Data Source

Which module do you want to import data into?

After selecting the module, click "Next" to continue the import. The steps to complete the import are identical to performing an import from the module. For more information on how to perform an import, please refer to the [Import](#) documentation in the Application Guide.

Backups

Sugar Support can schedule and provide backups on a one-time or recurring basis, based on your organization's needs. For some SugarCloud customers, backup files are available to access and download via the Backups module in Sugar.

For more information, please refer to the [Downloading Backups From the Backups Module](#) article.

Repair

Repair allows administrators to perform common maintenance routines on their instance of Sugar. The repair menu is available to only administrative users and can be accessed through Admin > Repair.

For more information on the different repair options available, please refer to the [Repair](#) documentation in the Administration Guide.

Diagnostic Tool

Diagnostic Tool allows administrators to create a file with many diagnostic and configuration details. This tool will collect basic system information regarding Sugar and server configuration and place it all into a zip file to help debug or diagnose issues. The Diagnostic Tool has options that you can turn on and off to include only specific configuration data. Select one or more of the following available options:

Option	Description
SugarCRM config.php	Includes a copy of the config.php file from the root directory of Sugar. This file contains many useful system settings options in Sugar. Note: The database password contained in this file is replaced with asterisks before sending for security purposes.
SugarCRM Custom directory	Includes a copy of the entire custom directory in Sugar
Phpinfo()	Includes the output of the PHP function phpinfo() saved to an HTML file. The phpinfo() function returns information about how PHP is configured on the server running Sugar including the version of PHP, the loaded Extensions, and more.
MySQL - Configuration Table Dumps	Includes an HTML file for each configuration table in Sugar. The file has three sections: field definitions, indexes, and data.
MySQL - All Tables Schema	Includes an HTML file titled MySQLTablesSchema.html which has two sections for each table in Sugar:

	field definitions and indexes.
MySQL - General Information	Includes an HTML file titled MySQL-General-info.html. This file contains some basic information about the MySQL database Sugar is running on such as version number and character sets.
MD5 info	Includes a PHP file that shows any file in your instance of Sugar that has a different hash than the stock file. This can indicate which files are customized and where they are located in your file system.
Copy files.md5	Includes the list of all files and their original md5 hash in a file titled files.md5. Note: Only available when the MD5 info option above is selected.
Copy MD5 Calculated array	Includes the list of all files and their current hash in a PHP file titled md5_array_calculated.php. Note: Only available when the MD5 info option above is selected.
BeanList/BeanFiles files exist	Includes an HTML file titled beanFiles.html. This file contains a list of the modules in Sugar and checks all the references for that module to make sure they are correct.
SugarCRM Log File	Includes a copy of the current log file for Sugar.
Sugar schema output (VARDEFS)	Includes an HTML file titled vardefschema.html which contains detailed metadata on each table in Sugar.

The more options selected, the bigger the resulting zip file will be. Select the desired options and click "Execute Diagnostic".

Diagnostic Tool

Execute Diagnostic Cancel

SugarCRM config.php	<input checked="" type="checkbox"/>
SugarCRM Custom directory	<input checked="" type="checkbox"/>
phpinfo()	<input checked="" type="checkbox"/>
MySQL - Configuration Table Dumps	<input type="checkbox"/>
MySQL - All Tables Schema	<input type="checkbox"/>
MySQL - General Information	<input type="checkbox"/>
MD5 info	<input type="checkbox"/>
- Copy files.md5	<input type="checkbox"/>
- Copy MD5 Calculated array	<input type="checkbox"/>
BeanList/BeanFiles files exist	<input type="checkbox"/>
SugarCRM Log File	<input checked="" type="checkbox"/>
Sugar schema output (VARDEFS)	<input type="checkbox"/>

Once the diagnostic tool is finished, select "Download the diagnostic file" to download the zip file containing the results to your computer.

Diagnostic Tool

Executing Diagnostic Operations...

100%

Getting config.php...
Done

Getting custom dir...
Done

Getting phpinfo()
Done

Getting sugarcrm.log
Done

[Download the Diagnostic file](#)
[Delete the Diagnostic file](#)

Optionally, you can then select "Delete the Diagnostic file" to remove it from the server. Large diagnostic files should be deleted from the server as they can pile up and take necessary disk space.

Tracker

Tracker allows administrators to configure the system to track certain user actions and information for Sugar modules. This information is used in tracker reports and dashlets. By default the tracker options are disabled.

Use the following options to record tracker data:

- **Tracker Actions** : Tracks user actions such as modules accessed and records saved.

- **Tracker Sessions** : Tracks active users' session data such as session length.
- **Tracker Performance** : Tracks system performance such as database round trips, number of files accessed, server response time, and memory usage.
Note: This option can cause performance issues and should not be enabled in a production environment.
- **Tracker Queries** : Tracks any query that takes longer than the specified slow query time threshold and saves the data to the database. Tracker queries logs the query, how many times it has been run, the last time ran, and the average seconds the query took. "Log slow queries" also needs to be selected before this option tracks data.
Note: This option can cause performance issues and should not be enabled in a production environment.
- **Log slow queries** : Select this option to log queries that take longer than the slow query time threshold to the sugar log. This is useful for performance debugging.
Note: This option can cause performance issues and should not be enabled in a production environment.
- **Number of days of Tracker data to store when Scheduler prunes the tables** : Specify the number of days of data to be retained. The Prune Tracker Tables scheduler will remove any tracker records older than the specified number of days. For more information on the Prune Tracker Tables scheduler, please refer to the [Prune Tracker Tables](#) section of the Scheduler documentation in the Administration Guide.
- **Slow query time threshold (msec)** : Specify a threshold in milliseconds to begin logging slow queries at. If "Log slow queries" is selected, queries that take longer to process than the threshold duration will be recorded in the Sugar Log. If "Tracker Queries" is selected, queries will be logged to the database.

Select the desired settings and click "Save" to preserve your changes.

Tracker

	Enabled
Tracker Actions: ⓘ	<input type="checkbox"/>
Tracker Sessions: ⓘ	<input type="checkbox"/>
Tracker Performance: ⓘ	<input type="checkbox"/>
Tracker Queries: ⓘ	<input type="checkbox"/>
Log slow queries:	<input type="checkbox"/>
Number of days of Tracker data to store when Scheduler prunes the tables	<input type="text" value="30"/>
Slow query time threshold (msec):	<input type="text" value="100"/>

Note: Changing the Log slow queries and Slow query time threshold values will also change them in Admin > System Settings.

Scheduler

Scheduler provides administrators with a method to automate the execution of custom and system processes. The Scheduler menu is available to only administrative users and can be accessed through Admin > Scheduler.

For more information on the different schedulers available, please refer to the [Schedulers](#) documentation in the Administration Guide.

PDF Manager

PDF Manager allows administrators to create and manage templates for generated PDF files for any deployed module, custom or standard. The PDF Manager is available to only administrative users and can be accessed through Admin > PDF Manager.

For more information on the PDF Manager, please refer to the [PDF Manager](#) documentation in the Administration Guide.

Mobile

The Mobile settings on the Administration page allow administrators to configure what modules they want enabled or disabled for Sugar Mobile and the browser-based Sugar mobile application. In addition, you can enable the mobile offline capability for your instance for Sugar Mobile.

The browser-based Sugar mobile application allows users to access various Sugar modules (stock and custom modules) via a web browser on a smartphone or PDA. Sugar Mobile is a native mobile application that enables users to access Sugar from mobile devices. For a list of supported devices for Sugar Mobile, please refer to the [Mobile Supported Platforms](#) page.

You can add, edit, and remove fields, including Calculated Value fields, to customize the mobile layouts via Admin > Studio. For more information on configuring fields, please refer to the [Fields](#) section of the Developer Tools documentation. For more information on configuring the mobile layouts, please refer to the [Mobile Layouts](#) section of the Developer Tools documentation.

Note: Calculated Value fields will not be updated in real-time for mobile edit view

layouts.

Configuring Sugar Mobile

You can configure what modules are available for use in Sugar Mobile via Admin > Mobile. Please note that the Bug Tracker, Campaigns, Contracts, Knowledge Base, Products, and Targets modules are not available for Sugar Mobile. For more information on enabling modules for Sugar Mobile, please refer to the [Enabling Modules for Mobile Access](#) section of this documentation.

Configuring Mobile Browser Access

The modules enabled for use via Admin > Mobile will also apply to the browser-based Sugar mobile application. For more information on enabling modules for the browser-based Sugar mobile application, please refer to the [Enabling Modules for Mobile Access](#) section of this documentation. Please note that the Reports module is not available for the browser-based Sugar mobile application.

Enabling Modules for Mobile Access

Use the following steps to enable modules for mobile access:

1. Navigate to Admin > Mobile.
2. To enable a module for the browser-based and native Sugar mobile application, drag and drop the module from the Disabled Modules column to the Enabled Modules column.
3. To disable a module, drag and drop the module from the Enabled Modules column to the Disabled Modules column.

Mobile

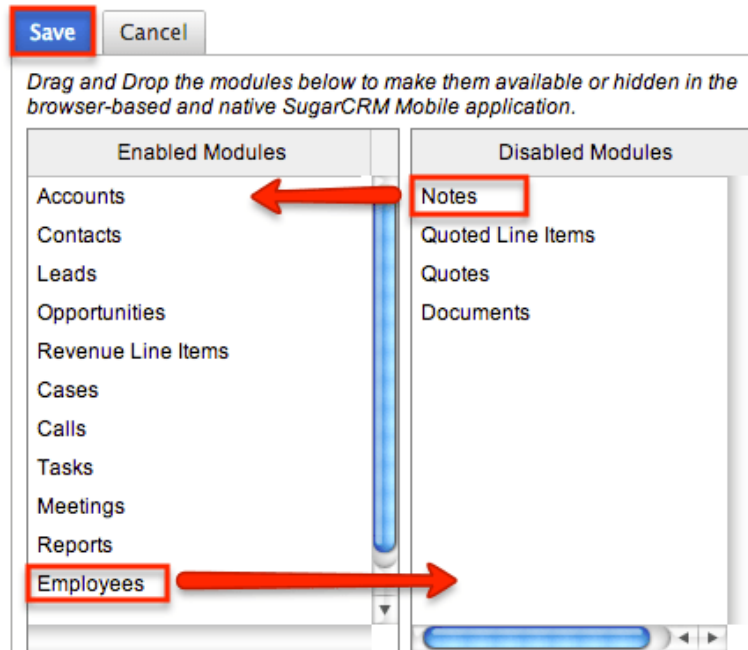

4. Click "Save" to apply the changes made to Sugar Mobile and the browser-based Sugar mobile application.

Enabling Offline Mobile Access

You can also allow mobile offline capabilities for your instance in Sugar Mobile by marking the Offline enabled checkbox in Admin > Mobile. Enabling offline access allows the user's mobile device to cache records for offline viewing as well as buffer changes they make to records while offline. The changes made will be synced once they are reconnected. Please note that the offline option must be enabled in Sugar first before users can enable the offline mode on their devices. For more information on enabling offline in mobile devices, please refer to the [Sugar Mobile User Guide](#) for your specific mobile device type (iPhone, Android).

Drag and Drop the modules below to make them available or hidden in the browser-based and native SugarCRM Mobile application.

Enabled Modules	Disabled Modules
Accounts	Notes
Contacts	Quoted Line Items
Leads	Quotes
Opportunities	Documents
Revenue Line Items	
Cases	
Calls	
Tasks	
Meetings	
Reports	
Employees	

Offline Settings
Offline enabled

Last Modified: 2020-05-26 16:55:12

Repair

Overview

The repair functions in Sugar allow administrators to perform common maintenance routines on their instance of Sugar. The repair menu is available to only administrative users and can be accessed through Admin > Repair. The following sections are available options from the repair menu.

Quick Repair and Rebuild

The quick repair and rebuild is the most commonly used repair option and should be performed after significant changes have been made to your instance of Sugar. If you notice inconsistencies with module layouts or fields as you have customized them via Studio, this option is normally the best first course of action to try and correct the issue. Sugar caches files to help access necessary files quickly. This option clears out many of the cached files in Sugar which allows new versions of the files to be loaded. The quick repair and rebuild option performs the following

actions:

- **Clear Vardefs From Cache** : Deletes any *vardefs.php file in the cached modules folder
- **Clear Language Files From Cache** : Deletes any {Module Name}.lang.php file in the cached modules folder
- **Clear Template Files From Cache** : Deletes any *.tpl files in the cached modules folder
- **Clear JavaScript Files From Cache** : Deletes any *.js files in the cached modules folder
- **Clear JavaScript Language Files From Cache** : Deletes any *.js files in the cached jsLanguage folder
- **Clear Dashlet Files From Cache** : Deletes any *.php files in the cached dashlets folder
- **Clear Sugar Feed Files From Cache** : Deletes the Sugar Feed files in cached modules folder
- **Clear Smarty Template Files From Cache** : Deletes any *.tpl.php files in the cached smarty templates folder
- **Clear Theme Files From Cache** : Deletes theme files in the cached theme folder for all themes in Sugar
- **Clear XML Files From Cache** : Deletes any *.xml files in the cached xml folder
- **Clear Search Files From Cache** : Deletes the unified_search_modules.php file in the cached module folder
- **Clear External API Cache Files** : Deletes the external API cache PHP and JavaScript files in the cached include folder
- **Clear Additional Cache Files** : Loops through the cached API folders and deletes any *.php files as well as the cached clients folder
- **Clear PDF Font Cache Files** : Deletes the cached PDF font list file
- **Rebuild Extension Files** : Rebuilds language files, extensions, dashlet containers, relationships, and the table dictionary; this step also clears any cached files by APC or WinCache, resets the Zend accelerator, clears eAccelerator's cache, and clears XCache cached files
Note : These functions will only run if the associated systems are installed and running.
- **Rebuild Audit Tables** : Creates audit tables for any module that has audit enabled and where the audit table does not already exist; the results for each table are printed on the page
- **Repair Database Tables** : Checks to make sure the database is in synch with the table dictionary and vardef files; any missing tables, columns, and indexes will be scripted to be recreated as well as any column properties that are incorrectly set in the database. The screen will display any database changes that should be made. Click "Execute" to execute the script to apply the changes to the Sugar database or click "Export" to save the script to a SQL file.

Differences found between database and vardefs

The following script will sync the database structure with the structure defined in the vardefs. You have the option of exporting this script and then running it against your database using external database management tools, or to allow the administration module to run the script.

NOTE: any changes you make to the script in the textbox will be reflected in the exported or executed code.

```
/* Table : accounts */
/*COLUMNS*/
/* INDEXES */
/*MISSING INDEX IN DATABASE - idx_accnt_assigned_del -index ROW */
ALTER TABLE accounts ADD INDEX idx_accnt_assigned_del (deleted,assigned_user_id);
/*Checking Custom Fields for module : Accounts */
CREATE TABLE accounts_cstm (id_c char(36) NOT NULL , PRIMARY KEY (id_c)) CHARACTER SET utf8 COLLATE utf8_general_ci;
/*MISSING IN DATABASE - test_c - ROW*/
ALTER TABLE accounts_cstm add COLUMN test_c varchar(100) NULL ;
/*MISSING IN DATABASE - testint_c - ROW*/
ALTER TABLE accounts_cstm add COLUMN testint_c int(150) NULL ;
```

Execute

Export

Upgrade Teams

The Upgrade Teams option performs some cleanup regarding team records in Sugar. This can be useful to restore the private teams for all users in the event they become corrupted or are removed for any reason. The upgrade teams option performs the following actions:

- **Global Team** : Creates or restores the global team if it does not exist or has been deleted. All users are then assigned to the global team if not already.
- **Private Teams** : Creates a private team for every user in the system that does not already have a private team and assigns the user to their private team.

The results are printed on the screen as to what teams already existed and what teams were created.

Expand Column Width

The expand column width option provides a fix for some limitations of MSSQL when requiring multi-byte characters in the database. This limitation only exists for systems running on a MSSQL database while using the MSSQL Drivers for PHP. This function is not available and not necessary to be run on any of the currently supported database platforms.

Note: We recommend running Sugar on at least version 2.0.1 of the SQLSRV

Drivers.

Use the following steps to run the Expand Column Width repair option:

1. Select "Expand Column Width" from the Admin > Repair screen.
2. Select from the dropdown which of the following actions you would like to take:

Display SQL : Displays the appropriate sql commands on the screen.

Export SQL : Creates a .sql file containing the appropriate SQL commands.

Execute SQL : Executes the SQL commands on your database.

3. Select "Go" to perform the selected action.

What action would you like to take?

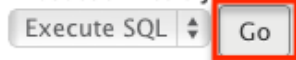

4. The script takes any field in the database that is type varchar, char, or text and increases the length of the field. The new length is set to three times the current length, or if that is higher than 255, the length is set to 255.

Rebuild .htaccess File

Rebuild .htaccess File option creates or updates the .htaccess file in the root of the Sugar directory. The .htaccess file contains specific commands to prevent unauthorized access to certain files and directories on your webserver. File permissions need to be configured correctly in order for Sugar to write to the .htaccess file. If writing to the file fails, the expected contents for the file will be printed on the page.

Note: If you have additional lines to add to the .htaccess file, place them outside of the "# BEGIN SUGARCRM RESTRICTIONS" and "# END SUGARCRM RESTRICTIONS" lines or they will be removed when running this repair function.

Rebuild Config File

The Rebuild Config File option takes the config.php file in the root directory of Sugar and rebuilds it to have all default values for any options not specified directly. It first runs a check to make sure Sugar can write to the config.php file and will return to you if it can or not. When ready to rebuild the config file select "Rebuild".

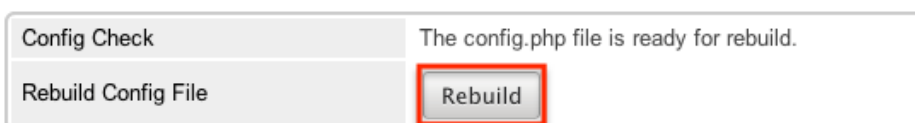

The default values for the config will be merged with any custom values currently

set and will be loaded into the config.php file.

Rebuild Sugar Logic Functions

The Rebuild Sugar Logic Functions rebuilds the cache files for all Sugar logic functions in the system. The Sugar logic functions are primarily used as formulas in field definitions. The results of the repair are shown on the screen.

Rebuild Relationships

Rebuild Relationships clears out the relationship cache and data and rebuilds it from the vardef files. Custom and stock relationships are all rebuilt. This repair option is good to run after an upgrade or when installing or uninstalling custom modules. The results of the repair are shown on the screen.

Rebuild Schedulers

The Rebuild Schedulers option removes all schedulers and recreates schedulers that come with Sugar by default. If you have customized the Active/Inactive flag, the frequency the job runs, or even deleted a job this repair option will restore all settings back to their original default value and recreate any deleted default schedulers.

Note: This also deletes any custom schedulers added to Sugar. If you have made changes to the default schedulers or created custom schedulers, please backup the details of each scheduler before running this repair.

The schedulers and their default settings are listed below:

Rebuild Schedulers Rebuild

Rebuilding your Scheduler Jobs will delete all existing job entries and their respective logs. All out-of-the-box Scheduler jobs will be

Name	Interval	Range	Status
Process Workflow Tasks	As often as possible.	01/01/2005 05:30am - 12/31/2020 06:59pm	Active
Run Report Generation Scheduled Tasks	On the hour; 06:00am	01/01/2005 02:15am - 12/31/2020 06:59pm	Inactive

Prune Tracker Tables	On the hour; 02:00am; 1st	01/01/2005 12:00pm - 12/31/2020 06:59pm	Active
Check Inbound Mailboxes	As often as possible.	01/01/2005 02:00am - 12/31/2020 06:59pm	Active
Run Nightly Process Bounced Campaign Emails	On the hour; From 02:00am to 06:00am	01/01/2005 02:00pm - 12/31/2020 06:59pm	Active
Run Nightly Mass Email Campaigns	On the hour; From 02:00am to 06:00am	01/01/2005 08:15am - 12/31/2020 06:59pm	Active
Prune Database on 1st of Month	On the hour; 04:00am; 1st	01/01/2005 02:15am - 12/31/2020 06:59pm	Inactive
Update tracker_sessions Table	As often as possible.	01/01/2005 01:00am - 12/31/2020 06:59pm	Active
Run Email Reminder Notifications	As often as possible.	01/01/2008 08:30am - 12/31/2020 06:59pm	Active
Clean Jobs Queue	On the hour; 05:00am	01/01/2012 04:15am - 12/31/2030 06:59pm	Active
Create Future TimePeriods	On the hour; 11:00pm	01/01/2012 01:30am - 12/31/2030 06:59pm	Active

Rebuild Sugar Dashlets

Rebuild Sugar Dashlets deletes the cached dashlets.php file and recreates it. This

file contains the path to the php files, the class to use, and the module for each dashlet in Sugar. This repair option is good to run when making changes to the dashlets that come with Sugar or custom dashlet loaded into Sugar. The results of the repair are shown on the screen.

Rebuild WorkFlow

Rebuild Workflow deletes files in the custom workflows folder for each module and then rebuilds the files from the workflow data in the database. This repair also verifies the proper logic hooks are in place to properly fire the workflows and rebuilds any plug-ins that are installed.

Rebuild Javascript Languages

The Rebuild Javascript Languages function deletes all files in the cached jsLanguage folder and deletes any {Module Name}.lang.php file in the cached modules folder. The cached files will be rebuilt when they are needed.

Rebuild Sidecar Files

Rebuild Sidecar Files will replace compressed JavaScript files for the Sidecar framework with original, full JavaScript source files. The full files will then be compressed (minified) to maximize application performance.

Rebuild JS Grouping Files

Rebuild JS Grouping Files takes the many different JavaScript files that are required with Sugar and concatenates them together into the cache directory.

Note: The process will continue working if you navigate away from this page, but if you wait you will see a notification on the page when it is complete.

Rebuild Sprites

Rebuild Sprites takes images in the following directories:

- ./include/images
- ./themes
- ./custom/themes

Creates the sprites and metadata files in the ./cache/sprites/ folder.

Note: The process will continue working if you navigate away from this page, but if you wait you will see a notification on the page when it is complete.

Repair Non-Lowercase Fields

The Repair Non-Lowercase Fields option takes any custom field defined in Sugar and, if the field contains an upper case letter, it will change the field to be lowercase. The database, vardef files, and views are all searched through and corrected for and uppercase fields. This option also clears any vardef files from the cache when finished.



Repair Teams

The Repair Teams option runs a quick check against the database for every user. It performs the following checks:

- Users not in the global team
- Users who do not have a private team
- Users who are not a member of a team that a user who reports to them is a member of

If any of the checks return true, the page will indicate that records were found and the associated action will be selected by default. Select the options you wish to perform and click "Rebuild".

The selected options will perform the following:

 Repair Non-Lowercase Fields	Repair mixed-case custom table(s) and metadata file(s) to fix issues wh lowercase field names
 Repair Teams	Rebuilds private team memberships based on user reporting hierarchy
 Repair Roles	Repairs Roles by adding all new modules that support Access Controls, new Access Controls to existing modules

- **Rebuild access to global team** : Create a global team if one does not exist and loops through every user and adds them to the global team.
- **Rebuild access to private team** : Loops through every user and creates a private team if one does not exist, and then adds the user to their private team.
- **Rebuild team hierarchy** : Loops through every user and makes sure every manager is included in their employees' teams. This ensures that if Sally reports to Jim, that Jim can see all of Sally's records.

Note : Sugar prevents a loop from being created via the Reports To field. For more information on setting the Reports To field, please refer to the [User Management](#) documentation.

- **Clean up unused combinations of teams** : Searches the database for unused combinations of teams and deletes the records from the database.

The users looped through are displayed on the screen when complete.

Repair Roles

Repair Roles goes through every ACL enabled module and ensures that there are appropriate database records to allow roles to be used on the specified module. This repair is important to run after adding new modules via Module Loader or Module Builder to make sure all of the role options are available for the new module. If there is a module that has ACL enabled for it, but the module does not show in the Roles section, then this repair option will add the module. The results of the modules accessed are printed on the screen.

Repair Inbound Email Accounts

Repair Inbound Email Accounts loops through every active inbound email account in Sugar and verifies the settings configured. Any Inbound email account that fails to successfully repair will be listed on the page and will require someone to manually repair them by reentering a valid user name and password.

Remove XSS

The Remove XSS repair loops through the database and removes any malicious scripts from specified field types. Select a module from the dropdown, or select "All" to run for all modules.

Removes XSS Vulnerabilities from the database

Select a module to remove potential XSS strings. Select "All" to address every module. Press execute to start the detection and removal process.

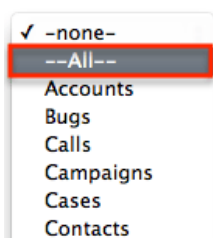

The page will then display the count of records that will be scanned, and repaired if necessary. Click "Execute" to begin the repair.

Removes XSS Vulnerabilities from the database

Select a module to remove potential XSS strings. Select "All" to address every module. Press execute to start the detection and removal process.

--All--

1768 Object(s) found

You will see the count of Object(s) Repaired incrementing as it is running. Once the repair is complete you will get a popup message saying "Done." and the count repaired should match the count of objects found.

Repair Activities

Repair Activities takes Call or Meeting records where the status field does not equal "Held" and updates the end date based on the duration of the activity. If the status equals "Held" or the record is marked as deleted, this repair will skip it. The screen will show "Done" when complete.

Enable/Disable Seed Users

The Enable/Disable Seed Users option will either enable or disable the default users that are installed with Sugar when selecting a demo installation. If the first seed user retrieved from the database is set to "Active" then this option will give you the option to "Deactivate" the seed users, otherwise, you have the option to "Activate" the seed users.

Enable/Disable Seed
Users

This option will set the status based on the option presented for all users that have an id that starts with "seed".

Note: If you did not populate Sugar with demo data when installing, this repair will return "No seed users" and will not do anything.

Clear Additional Cache

The Clear Additional Cache option loops through the cached API folders and deletes any *.php files as well as the cached clients folder. This option is also performed by the Quick Repair and Rebuild option. The screen will show "Done"

when complete.

Last Modified: 2019-12-05 15:47:53

Schedulers

Overview

Schedulers in Sugar provide users with a method to automate the execution of custom and system processes. Sugar comes with many default schedulers to perform jobs such as monitoring inbound emails, executing workflows, running reports and dispatching campaign emails. Schedulers are available only to administrative users and can be accessed through Admin > Schedulers.

Schedulers Fields

The Schedulers module contains a number of stock fields which come out of the box with Sugar. The following definitions are suggested meanings for the fields, but the fields may be leveraged differently to best meet your organization's needs.

Field	Description
Active From	Time the scheduler begins to be active per day
Active To	Time the scheduler stops being active per day
Date & Time End	Date and Time the scheduler will stop running on the specified interval
Date & Time Start	Date and Time the scheduler will begin running on the specified interval
Execute If Missed	Specifies if a scheduler should be executed during the next cron run in the event that cron did not run at the exact time a job is scheduled for
Interval	How often and when the schedule will run, defaults to every day, every minute

Job	The job to execute on the defined schedule
Job Name	The name or designation of the scheduler
Status	The current status of the scheduler (i.e. Active, Inactive)

Note: Any times configured for schedulers will be based on the admin user's time zone (user id = '1').

Default Schedulers

The default schedulers that packaged with Sugar are required for different activities throughout the application. The following lists the default schedulers and their default settings:

Name	Interval	Status
SugarBPM™ Scheduled Job	As often as possible.	Active
Activity Stream Purger	On the hour	Inactive
Check Inbound Mailboxes	As often as possible.	Active
Clean Jobs Queue	On the hour; 05:00am	Active
Create Future TimePeriods	On the hour; 11:00pm	Active
Elasticsearch Queue Scheduler	As often as possible.	Active
Process Workflow Tasks	As often as possible.	Active
Prune Database on 1st of Month	On the hour; 04:00am; 1st	Inactive
Prune Old Record Lists	As often as possible	Active
Prune Tracker Tables	On the hour; 02:00am; 1st	Active
Publish approved articles & Expire KB Articles	On the hour; 05:00am	Active
Rebuild Denormalized Team Security Data	Every 15 minutes	Inactive
Remove diagnostic tool files	On the hour; 04:00am; Sunday	Active
Remove temporary files	On the hour; 04:00am	Active

Remove temporary PDF files	On the hour; 04:00am	Active
Run Email Reminder Notifications	As often as possible.	Active
Run Nightly Mass Email Campaigns	On the hour; From 02:00am to 06:00am	Active
Run Nightly Process Bounced Campaign Emails	On the hour; From 02:00am to 06:00am	Active
Run Report Generation Scheduled Tasks	On the hour; 06:00am	Inactive
Sugar Heartbeat	On the hour; 04:00am	Active
Update tracker_sessions Table	As often as possible.	Active

SugarBPM Scheduled Job

The SugarBPM Scheduled Job is responsible for processes associated with the SugarBPM automation suite. It is active and runs as often as possible by default. The SugarBPM Scheduled Job will check for any active time-based process events in a pending state. If any processes meet this criterion, the scheduler will ensure the process flow continues. For more information about SugarBPM, please refer to the [SugarBPM](#) documentation.

Note: SugarBPM events processed by this scheduler will be run by the admin user (user id = '1') in Process History unless the admin user is disabled.

Activity Stream Purger

The Activity Stream Purger scheduler can help manage the number of activity stream records in the database. The scheduler is inactive by default with an interval set to run on the hour when enabled. As your company uses Sugar, the number of activity records will grow considerably over time which can result in performance degradation. For this reason, it is strongly recommended to enable the scheduler and set it to run at least weekly, if not daily, to prune older records from the activities table. By default, the scheduler will remove records that are older than 6 months as of the current date from the activities table. Please note that user posts, comments, and attachments are preserved but all other activity stream records generated from field updates, new record creation, linking/unlinking records will be removed by the scheduler.

Note: The number of months to keep activity records is configurable through the sugar config files by modifying the value of [\\$sugar_config\['activitystreamcleaner'\]\['months_to_keep'\]](#). In addition, you can modify the value of [\\$sugar_config\['activitystreamcleaner'\]\['keep_all_relationships_activities'\]](#) if you wish to keep link/unlink-type activity records in the table.

Check Inbound Mailboxes

The Check Inbound Mailboxes scheduler is active and runs as often as possible by default. This scheduler will retrieve any unread email from active group inbound email accounts configured in the system. Personal and bounce mail accounts are not checked by this scheduler. If the group email account is configured to create cases or to send auto-reply emails, then this scheduler will handle those tasks as well. For more information on how to set up and configure a group inbound email account, please refer to the [Email](#) documentation.

Clean Jobs Queue

The Clean Jobs Queue scheduler is active and runs every day at 5:00 AM by default. The jobs queue is essentially a log of when each scheduler has run. This scheduler will go through the job queues and either soft or hard delete old records in the jobs queue. A soft delete is simply hiding the record from Sugar, but keeping it in the database for recovery if necessary. A hard delete is permanently deleting it from the database. Job queue records will be soft and hard deleted by this scheduler with the following criteria:

- **Soft Delete** : Completed more than 7 days ago.
- **Hard Delete** : Completed more than 21 days ago.

Note: The number of days for a soft and hard delete are configurable through the sugar config files by modifying the values of [\\$sugar_config\['jobs'\]\['soft_lifetime'\]](#) and [\\$sugar_config\['jobs'\]\['hard_lifetime'\]](#).

Create Future TimePeriods

The Create Future TimePeriods scheduler is active and runs every day at 11:00 PM by default. When setting up the Forecasts module for the first time, you are prompted with what type of time period (Yearly or Quarterly) and how many future and past time periods you would like. This scheduler runs based off of those settings and creates new time period records as needed for forecast data entry.

For more information about configuring the time periods for forecasting, please refer to the [Forecast Configuration](#) documentation.

Elasticsearch Queue Scheduler

The Elasticsearch Queue Scheduler job is active and runs as often as possible by default. New records, revised records, and deleted records are queued to be processed by this scheduler and added to the full text search index. Though this scheduler is set to run as often as possible, it can take a few moments before changes are available in global search results. For more information about Search, please refer to the [Search](#) documentation.

Process Workflow Tasks

The Process Workflow Tasks scheduler is active and runs as often as possible by default. This scheduler processes and runs any time elapsed workflows are due to run. If you utilize time-elapsed workflows, it is highly recommended to run this scheduler as often as possible to ensure the workflows are executed quickly. For more information on creating workflows, please refer to the [Workflow Management](#) documentation.

Note: Workflows processed by this scheduler will be run by the admin user (user id = '1') unless the admin user is disabled.

Prune Database on 1st of Month

The Prune Database on 1st of Month scheduler is inactive and runs at 4:00 AM on the first day of every month. Sugar implements a soft delete feature when deleting records through the application. Instead of deleting the record right away, the system marks a field called deleted in the database for the record. This scheduler runs through every table in the Sugar database and deletes any record that has this deleted flag. This is beneficial to keep the database small and efficient but will remove the ability to recover accidentally deleted records. If you have a large database, we recommend activating this scheduler and running it once a month for performance.

Prune Old Record Lists

The Prune Old Record Lists scheduler is active and runs as often as possible by default. This scheduler job will clean up backend database entries Sugar uses when generating export files. Such entries that are older than 1 hour from the

current date and time will be removed from the record_list database table.

Keeping this scheduler active will help prevent exports from failing due to size limitations.

Prune Tracker Tables

The Prune Tracker Tables scheduler is active and runs at 2:00 AM on the first day of every month by default. This scheduler will delete data in the tracker tables based on the tracker prune interval. This interval can be set from Admin > Trackers and defaults to 30 days if not set. Any record older than the specified amount of days will be deleted from the following tables:

- tracker
- tracker_sessions
- tracker_perf
- tracker_queries
- tracker_tracker_queries

Keeping this scheduler active helps ensure overall system performance is kept at optimum levels, as these tables are continually updated via common actions in the application. For more information on trackers and setting this interval, please refer to the [Tracker](#) documentation.

Publish Approved Articles & Expire KB Articles

The Publish Approved Articles & Expire KB Articles scheduler is active and is set to run daily at 5:00 AM by default. This scheduler publishes any Knowledge Base articles that have a status of "Approved" and were scheduled for a later publish date. It also checks for any articles that have reached their expiration date and changes their statuses to "Expired".

Rebuild Denormalized Team Security Data

The Rebuild Denormalized Team Security Data scheduler is inactive by default with an interval set to run every 15 minutes when activated. Team Security denormalization can significantly improve SQL query performance when there are a large number of Teams in an on-site Sugar instance. This feature relies on a separate Team security denormalization table that needs to be updated as records change to ensure Sugar's team security visibility rules are applied properly. When denormalization is enabled via the [perfProfile.TeamSecurity.default.use_denorm](#) configuration and inline updates are disabled via

[perfProfile.TeamSecurity.inline_update](#), then the Rebuild Denormalized Team Security Data scheduler must be turned on to make sure the table is regularly updated.

Remove Diagnostic Tool Files

The Remove Diagnostic Tool Files scheduler is active and runs Sundays at 4:00 AM by default. The `./cache/diagnostic` directory serves as a temporary directory for data generated by Sugar's Diagnostic Tool, which allows administrators and developers to capture basic system and server configuration details in order to diagnose problems in a Sugar instance. The tool places this data into a zip file on the server. The Remove Diagnostic Tool Files scheduler will remove any of these temporary files from the directory once a week during off-peak hours. For more information about the Diagnostic Tool, please refer to the [Diagnostic Tool](#) documentation.

Remove Temporary Files

The Remove Temporary Files scheduler is active and runs daily at 4:00 AM by default. Sugar uses a cache directory to store files such as images, documents, and installable modules uploaded by users. Some of these documents may be large in size and can cause performance issues. This scheduler will remove any unused files that are found in the `./uploads/tmp` directory or in most user-configured upload directories. For more information about temporary file storage, please refer to the [Advanced Configuration Options](#) documentation.

Remove Temporary PDF Files

The Remove Temporary PDF Files scheduler is active and runs daily at 4:00 AM by default. The `./cache/pdf/` directory serves as a temporary directory for in-progress PDF files generated from reports, quotes, and other parts of Sugar. Upon successful completion of the PDF operation, the file is typically removed from the directory, but there may be circumstances where orphaned PDF files could remain in the directory. This scheduler will remove any PDF files from the directory during off-peak hours.

Run Email Reminder Notifications

The Run Email Reminder Notifications scheduler is active and runs as often as possible by default. This scheduler will send out email reminders for meetings and calls that have met or passed the reminder time. Meetings and calls need to have a

status that does not equal "Held" in order for the email reminder to be sent to invitees.

Run Nightly Mass Email Campaigns

The Run Nightly Mass Email Campaigns scheduler is active and runs on the hour, every hour from 2:00 AM to 6:00 AM by default. This scheduler will process any campaign emails waiting to be sent from the email queue up to the configured batch amount. If the number of emails to send per batch is set to 500, and this scheduler is set to run once an hour, then you will be sending 500 emails per hour. Please configure this scheduler and the number of emails to send per batch to allow the proper amount of email to be sent.

Note: Many email providers place limitations on email send rates such as emails per hour, emails per day, unique recipients, etc. Please check with your email provider to ensure that they will be able to process the volume of emails you desire to send through campaigns.

For more information on setting the number of emails sent per batch, please refer to the [Campaign Email Settings](#) documentation.

Run Nightly Process Bounced Campaign Emails

The Run Nightly Process Bounced Campaign Emails scheduler is active and runs on the hour, every hour from 2:00 AM to 6:00 AM by default. This scheduler will retrieve any unread email from active bounce inbound mail accounts configured in the system. Bounce email accounts are important for receiving any bounced emails from a campaign. Emails in the bounce mail account must match all of the following criteria to be classified as a bounced email:

- 'From' email address must contain MAILER-DAEMON or POSTMASTER.
- 'Remove me' link from the original email must be in the email body.
- The originating email does not have a campaign activity log type of invalid email or send error.

We recommend setting this scheduler to run at the same time and interval as the Run Nightly Mass Email Campaigns scheduler. For more information on how to set up and configure a bounce inbound email account, please refer to the [Email](#) documentation.

Run Report Generation Scheduled Tasks

The Run Report Generation Scheduled Tasks scheduler is inactive by default with an interval set to run daily at 6:00 AM when activated. This scheduler executes any scheduled reports and emails the results to the designated user. If you want to utilize scheduled reports, please enable this scheduler, otherwise, the reports will not be emailed. We recommend running this scheduler as often as possible, this way if someone schedules a report for 6:15 AM, they will not have to wait until 7:00 to receive the report. For more information on scheduling reports, please refer to the [Scheduled Reports](#) documentation.

Sugar Heartbeat

The Sugar Heartbeat scheduler is active with an interval set to run daily at 4:00 AM by default. This scheduler ensures that Sugar continues to receive heartbeat information even if no users have logged into your instance in the last three days. When this occurs, the Sugar heartbeat information will be sent automatically when cron runs.

Update tracker_sessions Table

The Update tracker_sessions Table scheduler is active and runs as often as possible by default. This scheduler updates the tracker_sessions table, setting all records that have a date older than six hours to not active. This ensures any user that is inactive for six hours or more will be logged out and their sessions will no longer be active. Please keep in mind that PHP settings on the server may be more restrictive than the six-hour limitation on inactivity this scheduler imposes.

Schedulers Module Tab

The Schedulers module tab can be accessed by navigating to the Administration page and clicking "Scheduler" in the System section. Once in the Schedulers list view, you can click the triangle in the Sugar Scheduler module tab to display the Actions, Recently Viewed, and Favorites menus. The Actions menu allows you to perform important actions within the module. The [Recently Viewed menu](#) displays the list of schedulers you last viewed in the module. The [Favorites menu](#) displays the list of schedulers you most recently marked as favorites in the module.

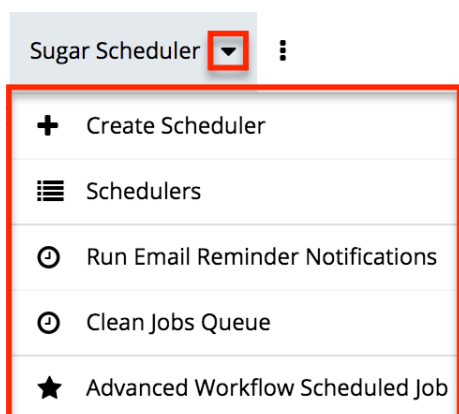

The Actions menu allows you to perform the following operations:

Menu Item	Description
Create Scheduler	Opens the edit view layout to create a new scheduler
Schedulers	Opens the list view layout to search and display schedulers

Creating Schedulers

There are various methods for creating schedulers in Sugar including via the Schedulers module and via duplication. The full edit view layout opens when creating the scheduler directly from the Schedulers menu and includes all of the relevant fields for your organization's schedulers. Schedulers can be created for built-in jobs within the application or they can be created to call a URL outside of Sugar.

Creating via Schedulers Module

One of the most common methods of scheduler creation is via the Create Scheduler option in the Sugar Scheduler module tab. This opens up the edit view layout which allows you to enter all the relevant information for the scheduler.

Use the following steps to create a scheduler via the Scheduler module:

1. Navigate to Admin > Scheduler.
2. Click the triangle in the Sugar Scheduler module tab and select "Create Scheduler".

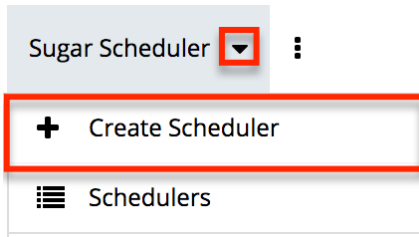

3. Enter appropriate values for the [fields](#) in the edit view layout. All required fields are marked with a red asterisk and must be completed prior to saving.

Note: For more information on setting the advanced options for the interval, please refer to the [Advanced Options](#) section.

4. Once the necessary information is entered, click "Save".

Create

Save Cancel

Job Name: * Refresh Jobs Status: Active

Job: Refresh Jobs

Creating via Duplication

You can also create a new scheduler by duplicating an existing scheduler record. The Copy option is useful if the scheduler you are creating has similar information to an existing scheduler.

Use the following steps to create a scheduler by duplicating an existing record:

1. Navigate to a scheduler record's detail view.
2. Select "Copy" from the Actions menu.

Run Nightly Mass Email Campaigns



3. The displayed edit view is pre-populated with the original scheduler's values. Update the necessary fields, then click "Save". For more information on setting the advanced options for the interval, please refer to the [Advanced Options](#) section.

Create

Job Name: *

Viewing Schedulers

There are various options available for viewing scheduler records in Sugar including via Schedulers list view, Schedulers detail view, and Schedulers Recently Viewed menu.

Viewing via List View

The Schedulers list view displays all scheduler records meeting the current search criteria. To access the list view, simply click the Schedulers module tab. While list view shows key scheduler fields, you can click the scheduler's name to open the record in detail view. For more information on viewing scheduler via list view, please refer to the [Schedulers List View](#) section.

Viewing via Detail View

The Schedulers detail view displays thorough scheduler information including all scheduler fields followed by the log records of when this scheduler has run. The detail view can be reached by clicking a scheduler record's link from anywhere in the application including from the Schedulers list view. For more information on viewing scheduler via detail view, please refer to the [Schedulers Detail View](#) section.

Viewing via Recently Viewed

As you work, Sugar will keep track of which scheduler you have recently viewed. Click the triangle in the [Sugar Scheduler module tab](#) to see a list of the three schedulers you most recently viewed. Clicking the scheduler name will open the scheduler in detail view.

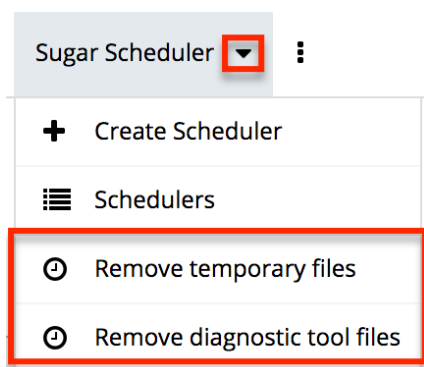

Searching Schedulers

The Schedulers list view includes a Basic Search to help you locate records easily and effectively in a module-specific manner. Once the search is performed, the relevant results will be displayed in the Schedulers list view below. Please note that Sugar automatically appends the wildcard character (%) to the end of your search phrase. This allows the system to retrieve all records that start with the keyword entered in the search. If you would like to broaden the search, you can use the wildcard at the beginning of your text as well (e.g. %services). This will pull up any record that has the word "services" in the name, regardless of how it starts or ends.

For more information on using the various search methods as well as how wildcards are used in the different methods, please refer to the [Search](#) documentation.

Basic Search offers a few, commonly used fields for a simplified search experience. The buttons in Basic Search panel have the following functions:

- **Search** : Click the Search button or press your Return/Enter key to perform the search.
- **Clear** : Click the Clear button to clear all criteria from the searchable fields.

Schedulers

Once the search is complete, the relevant results will populate in the [list view](#) below the search panel. To see all scheduler records, simply click "Clear" and then "Search" to perform a blank search with no filters.

Schedulers List View

The Schedulers list view displays all scheduler records meeting the current search criteria. You can view the basic details of each scheduler within the field columns.

Pagination

List view displays the current search results broken into pages that you can scroll through rather than displaying potentially thousands of rows at once. To the right just below the search panel, you can see which records of the total results set are currently being displayed. The two single-arrow Next and Previous buttons can be used to scroll through the records page-by-page. The two double-arrow First Page and Last Page buttons allow you to skip to the beginning or the end of your current results.

By default, Sugar displays 20 records per list view page, but administrators can change the number of records displayed via Admin > System Settings. For more information on changing the number of displayed records, please refer to the [System](#) documentation.

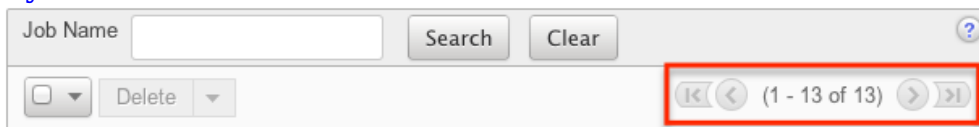

Checkbox Selection

You can perform several actions on scheduler records directly from the list view by first selecting the desired records. To select individual scheduler records on the Schedulers list view, mark the checkbox on the left of each row. To select or deselect multiple scheduler records in the list view, use the options in the checkbox dropdown menu:

- **Select This Page** : Selects all records shown on the current page of scheduler results.
- **Select All** : Selects all records in the current search results across all pages of scheduler results.
- **Deselect All** : Deselects all records that are currently selected.

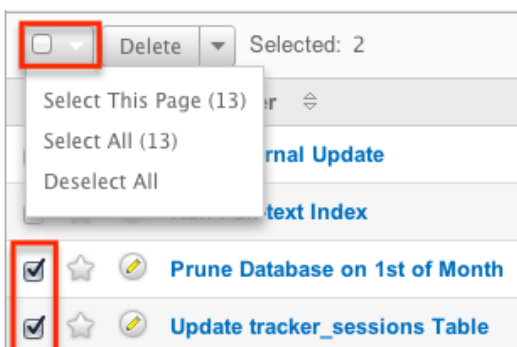

Actions Menu

The Actions menu to the right of the checkbox dropdown allows you to perform various actions on the currently selected records.

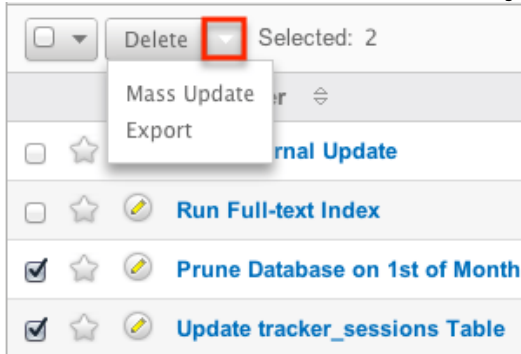

The options in the Actions menu allow you to perform the following operations:

Menu Item	Description
Delete	Delete one or more schedulers at a time
Mass Update	Mass update one or more schedulers at a time
Export	Export one or more schedulers to a CSV file

Favorite Designation

Users have the option to mark scheduler records as favorites via the list view as well as the detail view. This allows users to designate records that are important or will be viewed often so that they can easily be accessed via search or from the Schedulers module tab. In the Schedulers list view, the star on the left of each schedule's row is yellow once marked to indicate a favorite schedule. For more information on marking records as favorites, please refer to the [Favoriting Schedulers](#) section of this documentation.

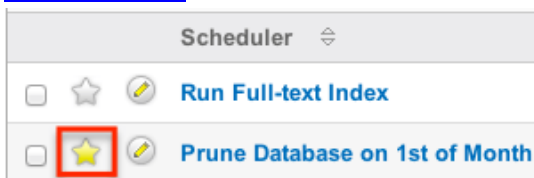

Column Sorting

List view provides the ability to sort all of the current search results by a field column in either ascending or descending order. To sort by a field or switch the sort direction, click the column header noting that the fields which allow sorting will have a pair of arrows. The list view may be sorted by only one column at a time.



Schedulers Detail View

The Schedulers detail view displays thorough scheduler information including all scheduler fields which are grouped by default into the Overview, More Information, and Other panels. You can also view a scheduler's log which appears in beneath the scheduler fields. The detail view can be reached by clicking a scheduler record's link from anywhere in the application including from the Schedulers list view.

Actions Menu

The Actions menu on the top left of each scheduler's detail view allows you to perform various actions on the current record. Administrator users can change the action items to be displayed as separate buttons instead of a dropdown menu via Admin > System Settings. For more information on configuring the actions menu, please refer to the [System](#) documentation.

Run Nightly Mass Email Campaigns ★



The options in the Actions menu allow you to perform the following operations:

Menu Item	Description
Edit	Edit this scheduler
Copy	Duplicate this scheduler
Delete	Delete this scheduler

Favorite Designation

Users have the option to mark scheduler records as a favorite via the detail view as well as the list view. This allows users to designate records that are important or will be viewed often so that they can easily be accessed via search or from the Schedulers module tab. In the Schedulers detail view, the star on the right of the scheduler's name is yellow once marked to indicate a favorite scheduler. For more information on how to mark records as favorites, please refer to the [Favoriting Schedulers](#) section of this documentation.

Prune Database on 1st of Month 

Edit ▾



Job Name:	Prune Database on 1st of Month
Date & Time Start:	01/01/2005 02:30pm
Date & Time End:	12/31/2020 06:59pm

Next or Previous Record

On the upper right of the Schedulers detail view, there are two buttons that allow you to page through each scheduler in the Schedulers list view's current search results. Clicking the Previous button displays the previous scheduler of the current search results while clicking the Next button displays the next scheduler of the current search results. The text in between shows which scheduler result you are currently viewing within the total number of current results.

Prune Database on 1st of Month 

Edit ▾

 (2 of 12) 

Job Log

Beneath a schedule record's fields is a subpanel containing the logs of when the scheduler has run. Each record will contain a Job Status field indicating the outcome of the job and an Execute Time field to show when the job started.

Job Log

Job Name	Job Status	Execute Time	Date Modified
Process Workflow Tasks	done	04/26/2013 05:30pm	04/26/2013 05:30pm
Process Workflow Tasks	done	04/26/2013 05:29pm	04/26/2013 05:29pm
Process Workflow Tasks	done	04/26/2013 05:28pm	04/26/2013 05:28pm

Editing Schedulers

Schedulers may be edited at any time to update or add information to the record. You can make changes to existing scheduler records via the Schedulers edit view and quick-create forms. Edit view is available within the Schedulers module and includes all of the Scheduler fields you should need.

[Process Workflow Tasks](#) » Edit

Job Name: *

Job:

Advanced Options:

Interval: *

Every Day Thursday
 Monday Friday
 Tuesday Saturday
 Wednesday Sunday

Quick Create is available for editing schedulers from outside the Schedulers module and opens as a pop-up without navigating away from your current page. It generally contains fewer fields, but the Full Form button may be used to access the full edit view should you need to edit additional fields.

Schedulers

Job Name Search Clear

Prune Database on 1st of Month

Job Name: *

Job:

Advanced Options:

Interval: * Every Hours Every Day Thursday Monday Friday Tuesday Saturday Wednesday Sunday

Save Cancel Full Form

For more information on setting the advanced options for the interval, please refer to the [Advanced Options](#) section.

Editing via Detail View

You can edit schedulers via the detail view by clicking the Edit button on the upper left of the page. Once the edit view layout is open, update the necessary fields, then click "Save" to preserve your changes.

Prune Database on 1st of Month

Edit

Job Name:	Prune Database on 1st of Month
Date & Time Start:	01/01/2005 02:30pm
Date & Time End:	12/31/2020 06:59pm

Editing via List View

You can edit schedulers via the list view by clicking the Pencil icon to the left of each scheduler's name. A pop-up window will open with the quick create form which is a shortened version of the edit view layout. Update the necessary fields, then click "Save" to preserve your changes.

Scheduler	Interval
Run Full-text Index	As often as possible.

Deleting Schedulers

If a scheduler record is invalid and should no longer appear in your organization's Sugar instance, it may be deleted from either the Schedulers detail view or list view. Deleting via the detail view allows you to delete a single record while the list view allows for mass deleting multiple records at once.

Note: If you wish to disable a scheduler but do not want to delete it, you can set the status to Inactive and it will not run.

Deleting via Detail View

Use the following steps to delete a scheduler record via the detail view:

1. Navigate to a scheduler record's detail view.
2. Select "Delete" from the Actions menu.

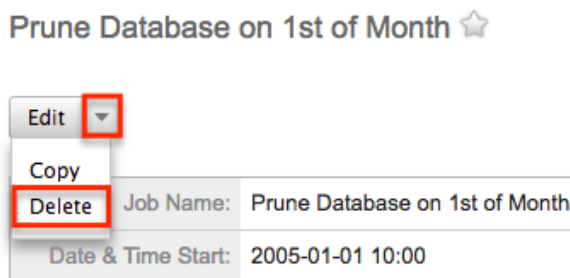

3. A pop-up message will display asking for confirmation. Click "Ok" to proceed.

Mass Deleting via List View

Use the following steps to delete one or more scheduler records via the list view:

1. Navigate to the Schedulers list view by clicking the Schedulers module tab.
2. Use the [Search](#) to find the scheduler records you wish to delete.
3. Select the desired scheduler records individually or using the [checkbox dropdown's](#) options.
4. Choose "Delete" from the Actions menu.

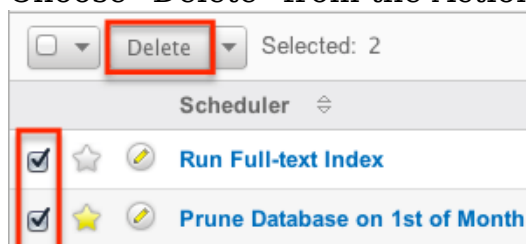

5. A pop-up message will display asking for confirmation. Click "Ok" to

proceed.

Due to PHP memory limitations on the server, there may be occasions when the application times out while deleting a large number of scheduler records. If you encounter an error when performing this action, we recommend selecting the records in smaller batches.

Exporting Schedulers

Sugar's Export option allows users to download all fields for the selected schedulers to their computers as a CSV (comma-separated values) file. This may be useful when needing to use Scheduler data with other software such as Microsoft Excel. Due to PHP memory limitations on the server, there may be occasions when the application times out while exporting a large number of scheduler records. If you encounter an error when performing this action, we recommend selecting the records in smaller batches.

Schedulers may be exported from the Schedulers list view by selecting "Export" from the Actions menu.

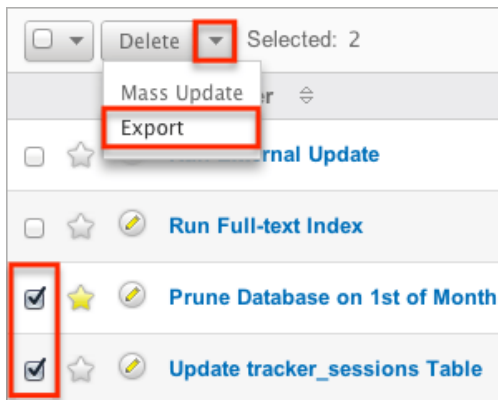

Mass Updating Schedulers

Mass updating allows users to make the same change to multiple scheduler records at once from the Schedulers list view. Currently, only fields with the data type of date, datetime, dropdown, multiselect, and radio may be altered during a mass update. Due to the PHP memory limitations on the server, there may be occasions when the application times out while mass updating a large number of scheduler records. If you encounter an error when performing this action, we recommend selecting the records in smaller batches.

Use the following steps to mass update scheduler records from the list view:

1. Navigate to the Schedulers list view by clicking the Schedulers module tab.

2. Use the list view's [Search](#) to find schedulers you wish to modify.
3. Select the desired schedulers individually or using the [checkbox dropdown's](#) options.
4. Choose "Mass Update" from the Actions menu.

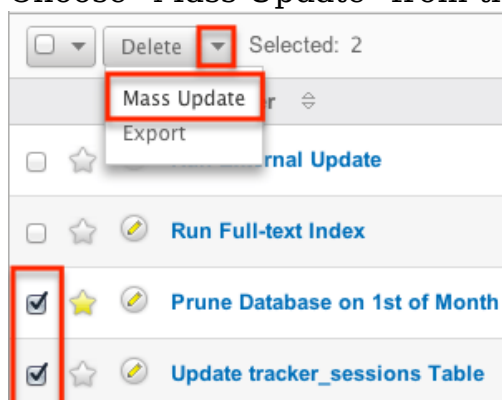

5. Scroll to the Mass Update panel and set values for the fields you wish to alter.

Mass Update

Job	-none-	Date & Time Start	
Date & Time End		Advanced Options	-none-
Last Successful Run		Status	-none-
Execute If Missed	-none-		

6. Click "Update" to save the changes to all of the currently selected scheduler records.

Favoriting Schedulers

Each Sugar administrator has the option to designate their own favorite schedulers that are important or will be viewed often. Once records are marked as favorites, you can select your most recent favorites directly from the [Sugar Scheduler module tab](#).

Favoriting via List View

Use the following steps to mark records as favorites via the Schedulers list view:

1. Navigate to the Schedulers list view by clicking the Schedulers module tab.
2. Use [Search](#) to find the scheduler records you wish to mark as favorites.
3. Click the star icon on the left of each desired scheduler's row.
4. To remove the scheduler as a favorite, click the star again to revert it to

white.

Scheduler		Interval
<input type="checkbox"/>	  Prune Database on 1st of Month	On the hour; 04:00am; 1st
<input type="checkbox"/>	  Run External Update	As often as possible.

Favoriting via Detail View

Use the following steps to mark records as favorites via the Schedulers detail view:

1. Navigate to a scheduler record's detail view.
2. Click the star icon to the right of the scheduler's name in the upper left of the detail view to designate it as a favorite.
3. To remove the scheduler as a favorite, click the star again to revert it to white.

Prune Database on 1st of Month 

Edit ▼

Job Name:	Prune Database on 1st of Month
Date & Time Start:	01/01/2005 02:30pm
Date & Time End:	12/31/2020 06:59pm

Advanced Options

From the edit view of a scheduler, you can select the Advanced Options checkbox to refine the interval of the scheduler as well as configure the Advanced Options panel.

Job Name: *

Job:

Advanced Options:

Interval: * min hrs date mo day

The above uses standard crontab notation.

Advanced Options

Execute If Missed:

Date & Time Start: * :

Date & Time End: :

This opens up the crontab notation for the interval field. Crontab notation gives administrators more flexibility to define when and how often the scheduler runs. Crontab notation allows you to enter a value for each time part for the job to run on. You can specify complex values by using the following notations:

Character	Description
*	Asterisk is used to represent every value for the specified time part. For example, * in the mins field will run every minute.
/	Forward slash is used to represent increments. For example, */15 in the mins field will run every 15 minutes. 30/5 in the mins field will run starting at the 30th minute of the hour and every 5 minutes after.
,	Comma is used to specify multiple values. For example, 18,20 in the hrs field will run at 6:00 PM and 8:00 PM.
-	Hyphen is used to specify a range of values. For example, 1-6 in the mo field will run from January through June.

Specify the values to run in the following interval fields using cron tab notation:

- **min** : Specify the minute of the hour to run on (0-59).
- **hrs** : Specify the hour of the day to run on (0-23).
- **date** : Specify the day of the month to run on (1-31).
- **mo** : Specify the month of the year to run on (1-12).
- **day** : Specify the day of the week to run on (0-6).

You may specify any combination of the fields to create the schedule needed to run the job.

Setting up Cron Scheduler

In order for the schedulers to run at the designated times, there needs to be a process running on the server to initiate the schedulers. This backend process will call the cron.php file in Sugar with some specific parameters, and the cron.php file will execute the schedulers as necessary.

Sugar instances hosted on Sugar's cloud service have the cron scheduler set up automatically, but it must be configured for on-site instances. In UNIX systems (MAC and Linux) you can configure crontab to run the schedulers. Navigate to Admin > Scheduler to get the system information necessary to set up the crontab.

To Setup Crontab

Note: In order to run Sugar Schedulers, add the following line to the crontab file:
* * * * * cd /var/www/sugar123; php -f cron.php > /dev/null 2>&1

Note: The scheduler is throttled by default to prevent it from running more often than every 30 seconds. This value is configurable by setting the `$sugar_config['cron']['min_cron_interval']` value in the `config_override.php` file.

Setting Up in Unix/Linux

Use the following steps to set up crontab to run the Sugar schedulers:

1. From a command prompt, execute the following command:

```
crontab -u apache -e
```

2. The text editor will launch as the user "apache". If your web server is running under a different user, please adjust the line accordingly.
3. Add the commands displayed on the Admin > Schedulers page of your Sugar application into the crontab file:

```
* * * * * cd /var/www/sugar123; php -f cron.php > /dev/null 2>&1
```

Note: Make sure that the path to the root directory of Sugar and to PHP is correct.

4. Save the changes to the file. This will run the cron job every minute.

You can check crontab to see what commands are being run by executing the

following command:

```
crontab -u apache -l
```

Last Modified: 2020-07-01 20:45:06

PDF Manager

Overview

The PDF Manager is used to create and manage templates for generated PDF files for any deployed module, custom or standard. Sugar comes with two PDF templates out of the box (Quote and Invoice).

Note: Legacy Quote PDF Templates (custom Quote templates created through code customizations) are not displayed in the PDF Manager but are still available in the Quotes module provided the templates were built off the TCPDF engine.

PDF Manager Fields

The PDF Manager module contains a number of stock fields which come out-of-the-box with Sugar. The below definitions are suggested meanings for the fields, but the fields can be leveraged differently to best meet your organization's needs.

Field	Description
Author	The author name to be placed in the PDF properties
Description	A description or other information about the template
Footer Text	The text to be placed in the template's footer
Header Logo File	Click "Choose File" to upload a header image to the template Note: The image will display as 454 pixels wide by 45 pixels high; the uploaded image should be sized relative to these dimensions.
Header Text	The text to be placed in the template's

	header
Header Title	The title of the template header
Keyword(s)	The keywords to be placed in the PDF properties
Module	The module this template will work in Note: Once a template is created, the module cannot be changed.
Name	The name or designation of the template
Published	Determines if a template is available to users or not
Subject	The subject to be placed in the PDF properties
Teams	The Sugar team(s) assigned to the template record
Template	The content of the template
Title	The title to be placed in the PDF properties

PDF Manager Module Tab

The PDF Manager module tab can be accessed by navigating to the Administration page and clicking "PDF Manager" in the System section. Once in the PDF Manager list view, you can click the triangle in the PDF Manager module tab to display the Actions and Recently Viewed menus. The Actions menu allows you to perform important actions within the module. The [Recently Viewed menu](#) displays the list of templates you last viewed in the module. Please note that clicking the module tab allows you to access the PDF Manager list view.

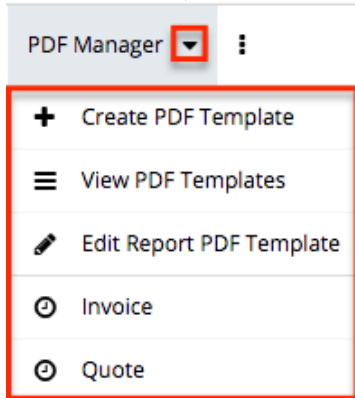

The Actions menu allows you to perform the following operations:

Menu Item	Description
-----------	-------------

Create PDF Template	Opens the edit view layout to create a new template
View PDF Templates	Opens the list view layout to search and display templates
Edit Report PDF Template	Opens the edit view layout to modify the report template

Creating PDF Templates

There are various methods for creating PDF templates in Sugar including via the PDF Manager module and duplication. The full edit view layout opens when creating the template directly from the PDF Manager menu and includes all of the relevant fields for your organization's templates.

Note: It is generally recommended to create a new template via duplication and then modify the copy to suit your needs.

Creating Via PDF Manager Module

You can create a new template via the Create PDF Templates option in the PDF Manager module tab. This opens up the edit view layout which allows you to enter all the relevant information for the template.

Use the following steps to create a template via the PDF Manager module:

1. Navigate to Admin > PDF Manager.
2. Click the triangle in the PDF Manager module tab and select "Create PDF Template".

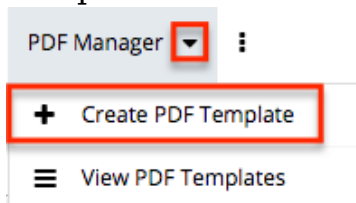

3. Enter appropriate values for the [fields](#) in the edit view layout. All required fields are marked with a red asterisk and must be completed prior to saving.
4. Once the necessary information is entered, click "Save".

Create

Name: *

Description:

Module: * 

Creating Via Duplication

You can also create a new template by duplicating an existing template record. The Copy option is useful if the template you are creating has a similar layout to an existing template.

Use the following steps to create a template by duplicating an existing record:

1. Navigate to a template record's detail view.
2. Click "Copy" from the Actions menu.

Invoice



Name:	Invoice
Description:	This template is used
Module:	Quotes

3. The displayed edit view is pre-populated with the original template's values. Update the necessary [fields](#), then click "Save".

Create

Name: *

Description:

Module: * 

Note: If you change the module field during duplication, you will have to remove all variable references to the old module in the layout before saving.

Creating Content

The PDF template can contain images and HTML formatting as well as variable fields from the assigned module. TinyMCE is the rich text editor for formatting your template using HTML. For more information on using TinyMCE, please refer to the [TinyMCE](#) section in the User Interface in the Application guide.

To add variable fields from the assigned module, simply select the desired field from the Field dropdown and then click "Insert".

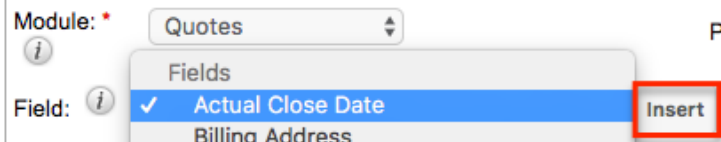

The variable will be placed wherever your computer's cursor is located in the template and can be moved around as necessary.

Note: The Link section provides all one-to-one and one-to-many relationships to provide linked data in the template.

For modules that have a subset of data in the template (e.g. Product line items in Quotes), there are special containers in the template that indicate where the repeating areas start and stop. These containers are designated by the following commands:

- **Start** : {foreach from=\$product_bundles item="bundle"}
- **End** : {/foreach}

Note: These lines are important and if removed can cause errors when generating a PDF. If you encounter an error when generating a PDF, we recommend checking the template for these start and end placeholders.

To add images to a PDF template, simply select the image icon in the toolbar. Fill out the image details (Image URL, Alignment, Dimensions, Border, etc.) in the Insert/Edit Image dialog then click "Insert".

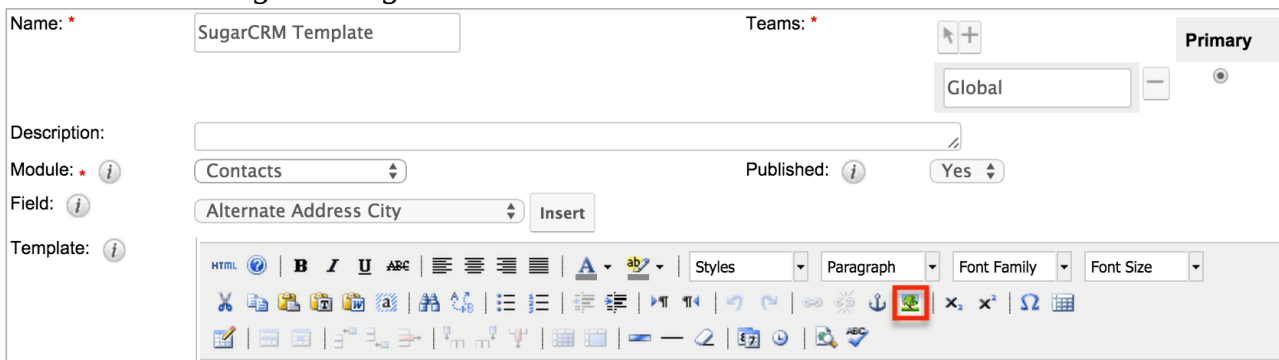

Note: Images cannot be copied and pasted or dragged and dropped into a PDF

template. The image icon must be used to insert an image.

Viewing PDF Templates

There are various options available for viewing template records in Sugar including via PDF Manager list view, PDF Manager detail view, and PDF Manager Recently Viewed menu.

Viewing Via List View

The PDF Manager list view displays all template records meeting the current search criteria. To access the list view, simply click the PDF Manager module tab. While list view shows key template fields, you can click the template's name to open the record in detail view. For more information on viewing templates via list view, please refer to the [PDF Manager List View](#) section.

Viewing Via Detail View

The PDF Manager detail view displays thorough template information including all template fields. The detail view can be reached by clicking a template record's link from anywhere in the application including from the PDF Manager list view. For more information on viewing templates via detail view, please refer to the [PDF Manager Detail View](#) section.

Viewing Via Recently Viewed

As you work, Sugar will keep track of which templates you have recently viewed. Click the triangle in the [PDF Manager module tab](#) to see a list of the 3 templates you most recently viewed. Click the template's name from the list to open it in detail view.

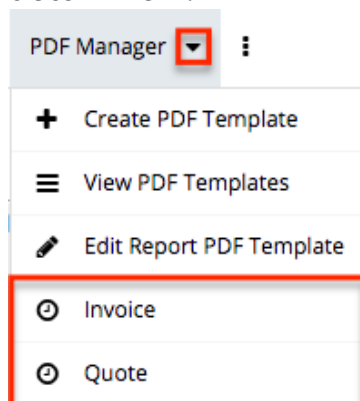

Searching PDF Templates

The PDF Manager list view includes a Basic Search to help you locate records easily and effectively in a module-specific manner. Once the search is performed, the relevant results will be displayed in the PDF Manager list view below. Please note that Sugar automatically appends the wildcard character (%) to the end of your search phrase. This allows the system to retrieve all records that start with the keyword entered in the search. If you would like to broaden the search, you can use the wildcard at the beginning of your text as well (e.g. %services). This will pull up any record that has the word "services" in the name, regardless of how it starts or ends.

For more information on using the various search methods as well as how wildcards are used in the different methods, please refer to the [Search](#) documentation.

Basic search offers a few, commonly used fields for a simplified search experience. The buttons and checkboxes available in Basic Search panel have the following functions:

- **Search** : Click the Search button or press your Return/Enter key to perform the search.
- **Clear** : Click the Clear button to clear all criteria from the searchable fields.

Search PDF Manager

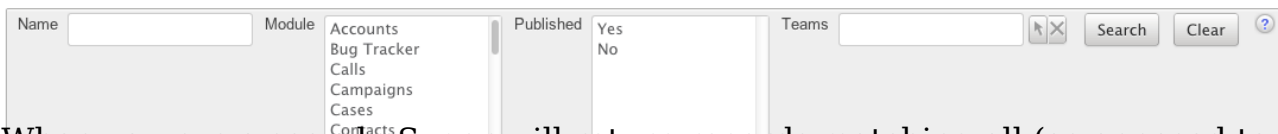

The screenshot shows a search interface titled "Search PDF Manager". It features several input fields: "Name", "Module" (with a dropdown menu open showing options like "Accounts", "Bug Tracker", "Calls", "Campaigns", "Cases", and "Contacts"), "Published" (with radio buttons for "Yes" and "No"), and "Teams". To the right of the "Teams" field are "Search" and "Clear" buttons, along with a help icon (question mark in a circle).

When you run a search, Sugar will return records matching all (as opposed to any) of the fields and checkboxes for which you have given a value. For example, if you select a module and enter a template name, Sugar will only return template records with a matching name that are assigned to that module. Once the search is complete, the relevant results will populate in the [list view](#) below the search panel. To see all template records, simply click "Clear" and then "Search" to perform a blank search with no filters.

PDF Manager List View

The PDF Manager list view displays all template records meeting the current search criteria. You can view the basic details of each template within the field columns.

Pagination

List view displays the current search results broken into pages that you can scroll through rather than displaying potentially thousands of rows at once. To the right just below the search panel you can see which records of the total results set are currently being displayed. The two single-arrow Next and Previous buttons can be used to scroll through the records page-by-page. The two double-arrow First Page and Last Page buttons allow you to skip to the beginning or the end of your current results.

By default, Sugar displays 20 records per list view page, but administrators can change the number of records displayed via Admin > System Settings. For more information on changing the number of displayed records, please refer to the [System](#) documentation in the Administration guide.

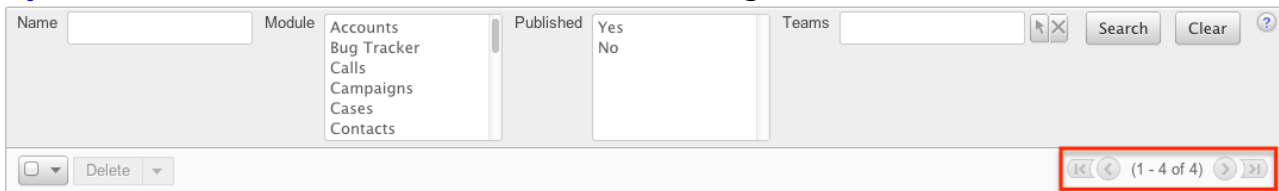

Checkbox Selection

You can perform several actions on template records directly from the list view by first selecting the desired records. To select individual template records on the PDF Manager list view, mark the checkbox on the left of each row. To select or deselect multiple template records on the list view, use the options in the checkbox dropdown menu:

- **Select This Page** : Selects all records shown on the current page of PDF template results.
- **Select All** : Selects all records in the current search results across all pages of PDF template results.
- **Deselect All** : Deselects all records that are currently selected.

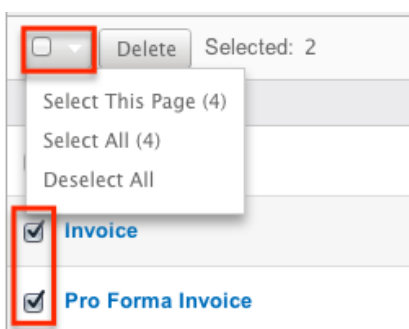

Actions Menu

The Actions menu to the right of the checkbox dropdown typically allows you to perform various actions on the currently selected records.

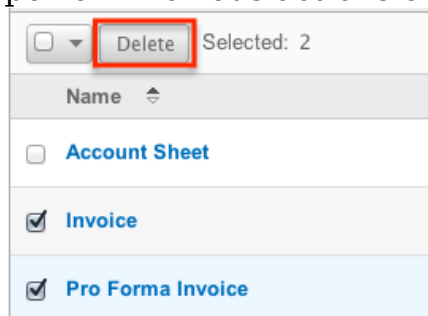

The only action available from the PDF Manager list view is the following operation:

Menu Item	Description
Delete	Delete one or more templates at a time

Column Sorting

List view provides the ability to sort all of the current search results by a field column in either ascending or descending order. To sort by a field or switch the sort direction, click the column header noting that the fields which allow sorting will have a pair of arrows. The list view may be sorted by only one column at a time.

Name	Module	Published	Date Created
<input type="checkbox"/> Account Sheet	Accounts	Yes	04/22/2013 11:19am

PDF Manager Detail View

The PDF Manager detail view displays thorough template information including all template fields which are grouped by default into the Overview and PDF Document Properties panels. The detail view can be reached by clicking a template record's link from anywhere in the application including from the PDF Manager list view.

Actions Menu

The Actions menu on the top left of each template's detail view allows you to

perform various actions on the current record. Administrator users can change the action items to be displayed as separate buttons instead of a dropdown menu via Admin > System Settings. For more information on configuring the actions menu, please refer to the [System](#) documentation in the Administration guide.

Invoice

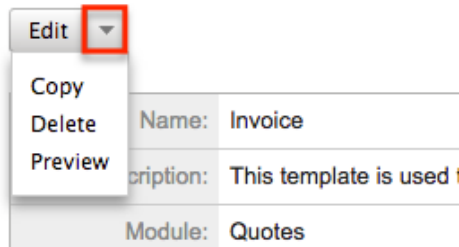

The options in the Actions menu allow you to perform the following operations:

Menu Item	Description
Edit	Edit this template
Copy	Duplicate this template
Delete	Delete this template
Preview	Preview this template

Next or Previous Record

On the upper right of the PDF Manager detail view, there are two buttons that allow you to page through each template in the PDF Manager list view's current search results. Clicking the Previous button displays the previous template of the current search results while clicking the Next button displays the next template of the current search results. The text in between shows which template result you are currently viewing within the total number of current results.

Pro Forma Invoice



Editing PDF Templates

Templates may be edited at any time to update or add information to the record. You can make changes to existing template records via the PDF Manager edit view. Edit view is available within the PDF Manager module and includes all of the template fields you should need.

[Pro Forma Invoice](#) » Edit

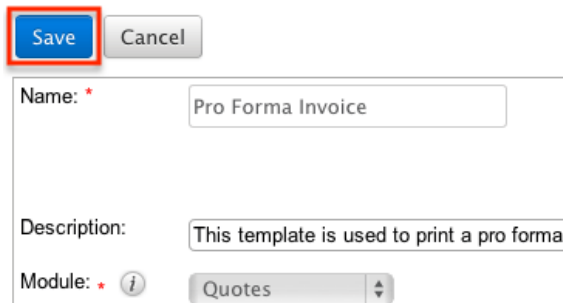

Save Cancel

Name: * Pro Forma Invoice

Description: This template is used to print a pro forma

Module: *  Quotes

Editing Via Detail View

You can edit templates via the [detail view](#) by clicking the Edit button on the upper left of the page. Once the edit view layout is open, update the necessary fields, then click "Save" to preserve your changes.

Pro Forma Invoice



Name:	Pro Forma Invoice
Description:	This template is used to print apro forma
Module:	Quotes

Editing Report PDF Template

The Report PDF Template is used when generating a report as a PDF. The report template may be edited at any time to include your company's logo. This logo displays in the header for all Report PDF files. The image will display as 454 pixels wide by 45 pixels high; the uploaded image should be sized relative to these dimensions.

You can edit the report template via the [detail view](#) by selecting the Edit Report PDF Template option from the PDF Manager module tab.

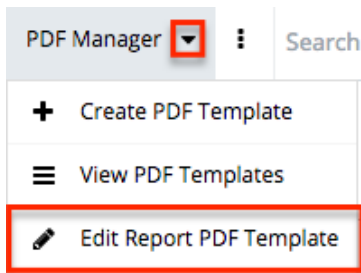

Once the edit view layout opens, update the necessary fields, then click "Save" to preserve your changes.

Report PDF Template

A screenshot of a 'Document Properties' dialog box. At the top, there are two buttons: 'Save' and 'Cancel'. The 'Save' button is highlighted with a red rectangular box. Below the buttons, the dialog is titled 'Document Properties' and contains two input fields: 'Title:' with the value 'Report generated from SugarCRM' and 'Author: *' with the value 'SugarCRM'.

Deleting PDF Templates

If a template record is invalid or should no longer appear in your organization's Sugar instance, it may be deleted from either the PDF Manager detail view or list view. Deleting via the detail view allows you to delete a single record while the list view allows for mass deleting multiple records at once.

Deleting Via Detail View

Use the following steps to delete a template record via the detail view:

1. Navigate to a template record's detail view.
2. Select "Delete" from the Actions menu.

Invoice

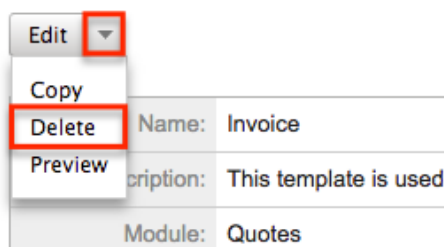

3. A pop-up message will display asking for confirmation. Click "Ok" to

proceed.

Mass Deleting Via List View

Use the following steps to delete one or more template records via the list view:

1. Navigate to the PDF Manager list view by clicking the PDF Manager module tab.
2. Use the [Basic Search](#) to find the template records you wish to delete.
3. Select the desired template records individually or using the [checkbox dropdown's](#) options.
4. Choose "Delete" from the Actions menu.

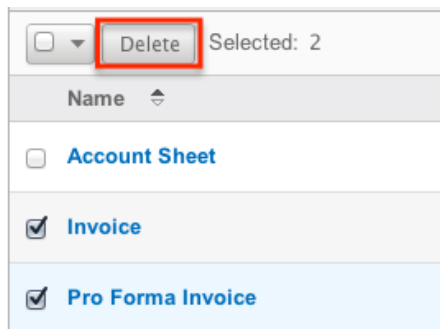

5. A pop-up message will display asking for confirmation. Click "Ok" to proceed.

Due to PHP memory limitations on the server, there may be occasions when the application times out while deleting a large number of template records. If you encounter an error when performing this action, we recommend selecting the records in smaller batches.

Adding a Header Image to PDF Template

Image files can easily be uploaded from your local machine to be used as a header image on a PDF template. After uploading and saving the image to the template's Header Logo File field, it will be shown on the PDF generated by users in Sugar.

Header images will display as 454 pixels wide by 45 pixels high, so the uploaded image should be sized relative to these dimensions (e.g. 908x90 or 1816x80).

After saving an appropriately sized image file to your computer, use the following steps to add the header image to the PDF template:

1. Create a [new PDF template](#) or open up an existing template via Admin > PDF Manager.
2. Click the "Choose File" button in the Header Logo File field to open a file

selection window from your browser.

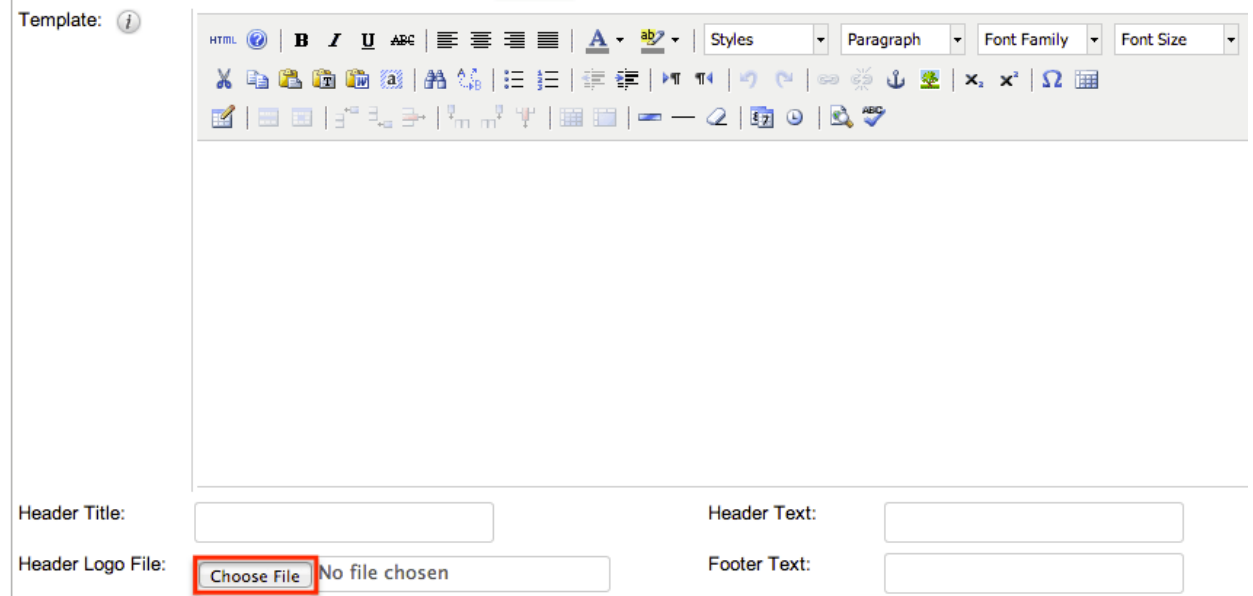

3. Select the image file from your local machine then click "Open" to add the image.

Please note that you must save then [preview the PDF template](#) in order to view the inserted header image.

Previewing PDF Templates

Previewing PDF templates allows you to see what the template will look like before publishing it in Sugar. The preview option displays the PDF template with the database field names and not actual data values and is accessible from the detail view.

Use the following steps to preview a template via the detail view:

1. Navigate to a template record's detail view.
2. Select "Preview" from the Actions menu.

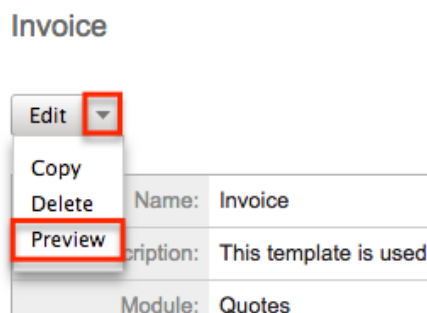

3. The PDF will download to your computer for viewing.

Web Logic Hooks

Overview

Web logic hooks allow you to establish events on a per module basis for Sugar to send data from the record in focus to an external URL so that additional processing can be completed outside the Sugar application. When a Web Logic Hook is triggered, the data is not sent instantaneously. Rather, the data is queued and processed under the Dispatch Web Logic Hook scheduled job. Once the job is processed through a regular scheduler run, the data for the record that triggered the hook is transmitted to the designated URL in a JSON format for further processing. This can allow you to send this data to other applications within your organization or to manipulate the data and transmit it back to Sugar via the REST API.

Web Logic Hook Fields

The Web Logic Hooks module contains a number of stock fields which come out-of-the-box with Sugar. For information on using and editing various field types, refer to the [User Interface](#) documentation. The below definitions are suggested meanings for the fields, but the fields can be leveraged differently to best meet your organization's needs.

Field	Description
Module Name	The module that the web logic hook will trigger off when the trigger event occurs in that module
Name	The name of the web logic hook
Request Method	The HTTP request method that the web logic will utilize to call out to the specified URL
Trigger Event	The event that must occur in order for the web logic hook to process
URL	The URL that will receive the data transmitted by the web logic hook

Note: This URL should be a URL outside of your SugarCRM instance. If you have an instance on Sugar's cloud service, it is your responsibility to host the URL that will process the web logic hook.

Working With Sugar Modules

While the Web Logic Hooks module has some features that only apply to web logic hooks, it also uses the Sidecar user interface that most Sugar modules are based on. In the table below, the left column contains links to the User Interface page covering topics that are applicable to all Sidecar modules. The right column has links to sections of the current page that cover topics specific to web logic hooks.

General Instructions for Working With Sugar Modules	Web-Logic-Hooks-Specific Instructions
Use the links below to navigate to the User Interface page which covers topics generic to many Sugar modules.	When Web-Logic-Hooks-specific help exists for each topic, use the links below to navigate to sections of the current page.
Creating Records	
Viewing Records	
Searching for Records	
List View	List View Mass Actions Menu List View Record Actions Menu
Record View	Record View Actions Menu
Intelligence Pane	
Editing Records	
Deleting Records	
Exporting Records	
Finding Duplicate Records	
Merging Records	
Sharing Records	

Web Logic Hooks Menus

The Web Logic Hooks module contains various options and functionality which are available via menus in the module tab, list view, and record view. The following sections present each menu and its options with links to more information about each option in the User Interface documentation.

Module Tab Menus

The Web Logic Hooks module tab is typically located on the navigation bar at the top of any Sugar screen after selecting "Web Logic Hooks" from the admin screen. Click the tab to access the Web Logic Hooks list view. You may also click the triangle in the Web Logic Hooks tab to display the Actions and Recently Viewed menus. The Actions menu allows you to perform important operations within the module. The [Recently Viewed menu](#) displays the list of web logic hooks you most recently viewed.

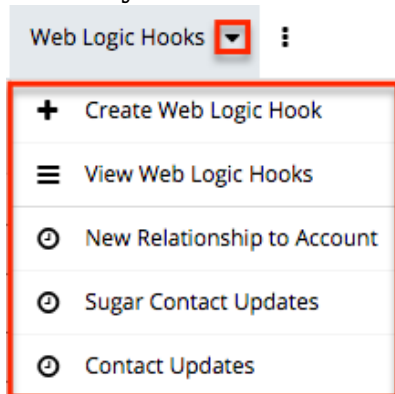

The module tab's Actions menu allows you to perform the following operations:

Menu Item	Description
Create Web Logic Hook	Opens the record view layout to create a new web logic hook
View Web Logic Hooks	Opens the list view layout to search and display web logic hooks

List View Menus

The Web Logic Hooks [list view](#) displays all web logic hook records and allows for searching and filtering to locate specific web logic hooks. You can view the basic details of each record within the field columns of the list view or click a web logic hook's name to open the record view. To access a module's list view, simply click the module's tab in the navigation bar at the top of any Sugar page.

List View Mass Actions Menu

The Mass Actions menu to the right of the checkbox option in the list header allows you to perform mass actions on all currently selected records. You can use the checkbox on each record's row to select individual web logic hook records or click the checkbox in the list header to select all records displayed on the current set of list view results.

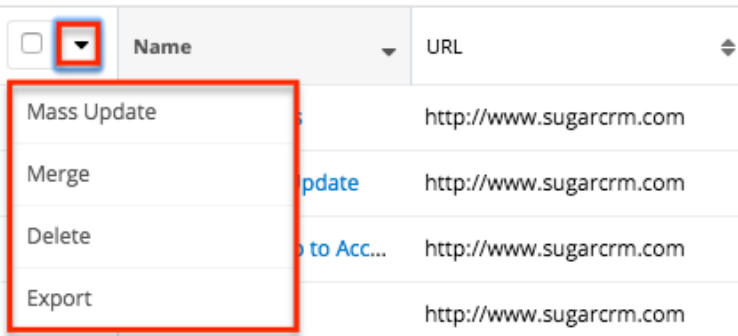

The Mass Actions menu allows you to perform the following operations:

Menu Item	Description
Mass Update	Mass update one or more web logic hooks at a time
Merge	Merge two or more duplicate web logic hooks
Delete	Delete one or more web logic hooks at a time
Export	Export one or more web logic hooks to a CSV file

List View Record Actions Menu

The Record Actions menu to the far right of each record's row allows you to perform actions on the individual web logic hook directly from the list view.

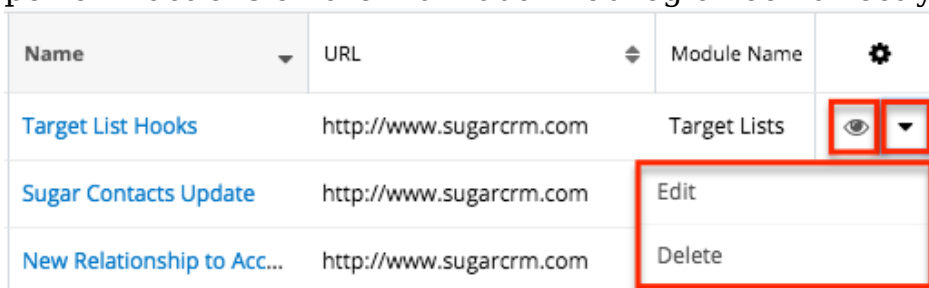

The list view's Record Actions menu allows you to perform the following operations:

Menu Item	Description
Preview (Eye icon)	Preview this web logic hook in the intelligence pane
Edit	Edit this web logic hook
Delete	Delete this web logic hook

Record View Actions Menu

The Web Logic Hooks [record view](#) displays a single web logic hook in full detail including its fields. To access a web logic hook's record view, simply click a hyperlinked web logic hook name from the Web Logic Hooks list view. The record view's Actions menu appears on the top right of the page and allows you to perform various operations on the current record.

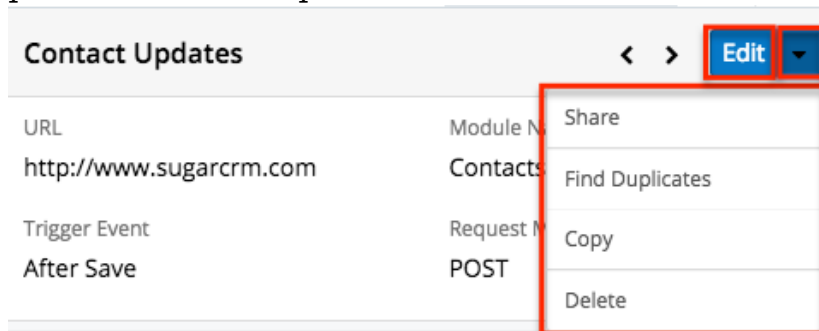

The Actions menu allows you to perform the following operations:

Menu Item	Description
Edit	Edit this web logic hook
Share	Share a link to this web logic hook via email
Find Duplicates	Locate potential duplicates of this web logic hook
Copy	Duplicate this web logic hook to create a new web logic hook
Delete	Delete this web logic hook

Email

Overview

Sugar comes with many different email-related capabilities, many of which require an administrator to set up or configure. Email administration covers the system email settings, campaign email settings, email archiving, inbound email, and managing the email queue.

Email Accounts

Outgoing Email Accounts

There are three types of outgoing email accounts used in Sugar:

- [System Email Account](#): The administrator sets up the system email account by configuring the System Email Settings. Sugar uses this account to send campaigns and email notifications such as password reset emails, record assignment notifications, and workflow alerts.
- **Default User Email Account** : A default email account is automatically created by Sugar for each user in Sugar. The default user account will use the primary email address stored in the user's profile. To use their default email accounts for sending email through Sugar, users must edit their profile and select "Sugar Email Client" as their outgoing email client. For more information on how users configure their user accounts, refer to the [Emails](#) documentation in the Application Guide.
Note: The users' default email accounts may be affected by the "Allow users to use this account for outgoing email" option in Admin > [System Email Settings](#). If the administrator has enabled the option, users will not be able to configure their default email account and must instead utilize the system email account or create a new user email account. Users will see the system email account in the Outgoing Email Accounts list view with an asterisk to indicate that it is a system account.
- **User Email Accounts** : User email accounts can be created by all users and can consist of the user's personal email accounts (e.g. jane@example.com) as well as any shared email accounts. Shared email accounts allow a group of users to send outbound email messages using the same email account (e.g. support@example.com). If you have existing group email accounts that should be available to select when composing

emails, it is recommended that you create a shared email account via Emails > Email Settings, making sure that it is assigned to the specific team(s) who can use the account to send emails. For more information on creating outgoing email accounts, refer to the [Emails](#) documentation in the Application Guide.

Note: The "[Allow users to configure email accounts](#)" option must be enabled in order for users to see the Create button to create new outgoing email accounts when they navigate to Emails > Email Settings.

Incoming Email Accounts

There are two types of incoming email accounts used in Sugar:

- [Group Mail Accounts](#): Group inbound email accounts allow multiple users, such as team members, to view emails from an external mail account. When emails are addressed to your organization but not to any particular user, you can route it to a Group mail account such as support@example.com or sales@example.com. Users can subsequently distribute emails in the Group mail account to other team members. Emails received to a Group mail account will have no assigned user unless "[Create Case from Email](#)" has been enabled for the account.
 - **Note:** Group Mail Accounts will only import unread messages from the mail server.
- [Bounce Handling Mail Accounts](#) : Bounce handling email accounts are configured to store campaign emails that are returned to the server, or "bounced" back to you due to incorrect email addresses or incompatible server settings on the receiving end. You can create a bounce handling inbox separately for each campaign, or you can create one that is common to all campaigns. The system tags every bounced campaign email with a unique identifier that enables you to identify the campaign.

System Email Settings

The System Email Settings section allows Sugar administrators to configure the system's outbound email settings as well as additional email and security options. Make any necessary changes in the sections below and click "Save" to commit the changes.

Email Settings



Outgoing Mail Configuration

The Outgoing Mail Configuration section contains details for sending email notifications, scheduled reports, workflow alerts, etc. Enter appropriate values for the following fields keeping in mind all required fields are marked with a red asterisk and must be completed prior to saving:

- **From Name** : The name outgoing email will come from; for example, the name of your organization. Defaults to "SugarCRM".
- **From Address** : The email address outgoing email will come from. Defaults to "do_not_reply@example.com".
 - **Note:** If specifying a different address than the email address associated with the account you are authenticating, the email server being utilized may need to be configured to allow the email account to send email as the entered From Address.
- **Choose Your Email Provider** : Choose your mail provider to populate provider-specific values.
- **SMTP Server** : The web address of the external email server Sugar will connect to.
- **SMTP Port** : The communication port number used for connecting to the mail server.
- **Use SMTP Authentication?** : Check this box to connect to the SMTP server using a user name and password. If left unchecked, the SMTP server must accept anonymous connections, which is not recommended.
- **Enable SMTP over SSL or TLS?** : Select the appropriate option from the dropdown to use Secure Socket Layer, Transport Layer Security, or no encryption when connecting to the mail server.
- **Email Address / Username** : Enter the email address or user name to connect to the SMTP server with.
- **Password** : Enter the password associated with the entered email address or user name.
- **Allow users to use this account for outgoing email** : Check this box if you would like users to be able to send emails using the same outbound mail account. If the option is not selected, users will still be able to use the outbound mail server to send emails by entering their personal mail account information in their user preferences. For more information on setting up the email settings in user preferences, please refer to the [Email Settings](#) section of the Getting Started documentation.

Once the appropriate mail server information is entered, you can send a test email to make sure it is configured properly. Click "Send Test Email", enter your email address, and send the test. If you do not receive the test email, re-enter the account information including the password to ensure it is all correct.

Outgoing Mail Configuration

Configure the default outgoing mail server for sending email notifications, including workflow alerts.

"From" Name: *

"From" Address: *

Choose your Email provider

SMTP Mail Server: *

Use SMTP Authentication:

Gmail Email Address *

Gmail Password *

Allow users to use this account for outgoing email:

SMTP Port: *

Enable SMTP over SSL or TLS?

Email Options

The Email Options section provides some global options for email configuration. Check the box next to the desired options:

Note: Logged in users must log out and back in for changes to the following settings to take effect.

- **Assignment Notifications** : When enabled (default), Sugar will send email notifications to users automatically when records are assigned to them. When assigning a record to yourself, you will not receive a notification of the assignment.
 - **Note:** To receive notifications, users must also have "Notify on Assignment" checked in their user profile.
- **Send notification from assigning user's e-mail address** : Enable this option to have Sugar send notifications from the email address and name of the user who is assigning a record to another user. This option is disabled by default.
 - **Note:** The SMTP server being used must allow sending from a different email address than the authenticated account and the email account may need to be configured to allow the Send As permission. For more information, please refer to the following articles:
 - [Configuring "Send As" Permissions With Exchange](#)

- [Configuring "Send As" Permissions With Office 365](#)
- [Configuring "Send As" Permissions With Gmail](#)

- **Allow users to configure email accounts** : Determines whether users can create new outgoing email accounts. When enabled (default), users will see a Create button when they navigate to Emails > Email Settings.
- **Opt-out new email addresses by default** : Enable this option to mark new email addresses added to Sugar records as opted out by default. Email addresses that are marked as opted out cannot receive campaign emails from Sugar. Please note that changing this setting will not affect email addresses already existing in Sugar. For more information on opted-out email addresses, please refer to the [Emails](#) documentation in the Application guide.

Email Security Settings

The Email Security Settings section allows Sugar administrators to decide which HTML tags are allowed to be displayed in Sugar. The selected tags will not be allowed for viewing within Sugar. There are two options to mass set the tag selection:

- **Select Outlook default minimum security settings** : Select this option to automatically select every tag that Outlook also restricts. This will not strip the style tag which is used by default in Outlook. This option is selected by default.
- **Toggle All Options** : Select this option to either select all tags or deselect all tags.

After selecting one of those options you can individually select or deselect additional tags to restrict or allow the tags respectively.

Email Security Settings

Check the following that should NOT be allowed in via InboundEmail or displayed in the Emails module.

Select Outlook default minimum security settings (errs on the side of correct display).

Toggle All Options

Applet tag <input checked="" type="checkbox"/> <applet>	Base tag <input checked="" type="checkbox"/> <base>
Embed tag <input checked="" type="checkbox"/> <embed>	Form tag <input checked="" type="checkbox"/> <form>
Frame tag <input checked="" type="checkbox"/> <frame>	Frameset tag <input checked="" type="checkbox"/> <frameset>
iFrame tag <input checked="" type="checkbox"/> <iframe>	Import tag <input checked="" type="checkbox"/> <import>
Layer tag <input checked="" type="checkbox"/> <layer>	Link tag <input checked="" type="checkbox"/> <link>
Object tag <input checked="" type="checkbox"/> <object>	Style tag <input type="checkbox"/> <style>
Xmp tag <input checked="" type="checkbox"/> <xmp>	

Related Contacts Emails

The Related Contacts Emails section allows administrators to enable or disable related contact's emails from appearing in the Emails subpanel and History dashlet for certain modules (Cases, Accounts, Opportunities). In order to have emails from related contacts appear in the Emails subpanel, simply mark the checkbox to the right of the module name (e.g. Opportunities). To disable related contact's emails from appearing in the Emails subpanel, uncheck the box for the specific module as necessary. Click "Save" to preserve the change.



Save Cancel

Enable/Disable emails from related (or linked) contacts to show in Email Subpanel.:

Cases: Accounts:

Opportunities:

Campaign Email Settings

The Campaign Email Settings section allows Sugar administrators to configure some backend settings for sending campaign emails. Select the appropriate values for the following fields:

- **Number of emails sent per batch** : When the "Run Nightly Mass Email Campaigns" scheduler runs, it will send out the specified number of emails for a single run. The default is set to 500. Some email servers have one or more of the following restrictions for a specific timeframe (e.g. hour, day, etc.): the number of unique recipients, how many times the same email can be sent to individual recipients, and the most common, how many emails can be delivered. This setting helps control the outgoing email to conform to these restrictions. For example, if your scheduler is set to run every hour, the number of emails to send per batch is set to 500, and you have 1600 emails to send out, starting at 2:00 AM the last batch of emails will be sent at 5:00 AM. Please check with your email provider to determine the proper level.
- **Location of campaign tracking files** : Campaign tracking files log responses from campaign targets. If you are running Sugar on an external network, select "Default" to accept the default location. However, if your Sugar instance is behind a firewall, then choose "User Defined" and specify the path to your external web server in the field below. The external web server must have the ability to connect to your Sugar instance behind the firewall. Ensure that you create a file named `index.php` to handle requests for three different types of entry points: `campaign_trackerv2`, `removeme`, and `image`, and place the `index.php` file in the path to your external web server. This `index.php` file must make the appropriate calls to the `index.php` file located in the root of your Sugar instance in order to properly record the activities in Sugar. For more information on how to setup a custom

campaign tracker page, please refer to the [Using a Custom Page For Campaign Trackers](#) section of the Advanced Config Options documentation in the Administration guide.

- **Keep copies of campaign messages** : Set this option to "Yes" to keep a copy of every email sent during a campaign. If "No" is selected, the template is saved and one copy of the email is stored in the Emails module. The email record will have an empty To field but the recipients will be visible in the email's related records subpanels. The default is set to "No".
 - **Note:** Storing every email sent does take up space in the database and can reduce performance. We recommend setting this value to "No".

Campaign Email Settings

Outbound Email Options

Number of emails sent per batch: *

Location of campaign tracking files (like campaign_tracker.php) * Default User Defined

Value of Config.php s

Keep copies of campaign messages: * Yes No

  Make any necessary changes and click "Save" to commit the changes.

Note: The Campaigns module is not available for Sugar Serve users. For more information on license types and the functionality available for each, refer to the [User Management](#) documentation.

Email Archiving

The Sugar Email Archiving service allows users to easily archive email to Sugar records simply by sending the email to a special email address. The email archiving service monitors the email address and imports the email into your instance of sugar and links related records without the use of a plug-in or other syncing process.

This section explains how the administrator can enable the Sugar Email Archiving service. For complete steps to use Sugar Email Archiving once it is enabled, please refer to the [Emails](#) documentation in the Application Guide.

Enabling Email Archiving

Before you can use Sugar Email Archiving, you need to enable the service for your

instance. Email Archiving can be enabled for multiple instances per license key, but each instance must be registered independently and receive its own, unique email address. If you clone an instance that has Email Archiving enabled, the clone will show as having Email Archiving enabled, but must have the service disabled and re-enabled in order to receive its own email address and start using the service. For further troubleshooting information, refer to the [Troubleshooting the Sugar Email Archiving Service](#) article.

Use the following steps to enable email archiving via the Administration page:

1. In the Email section of the administration page, Select "Email Archiving".
2. Read the Email Archiving feature description, Master Subscription Agreement, and privacy policy.
3. Select the checkbox to agree to the terms and click "Enable Email Archiving".

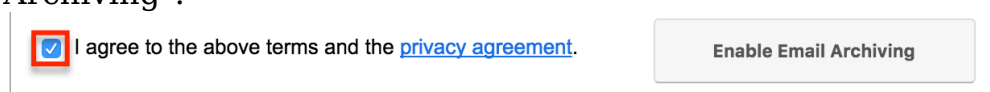

Note: Your instance needs to be reachable over the internet from SugarCRM's Email Archiving server. For more information, refer to the [Troubleshooting Sugar Email Archiving \(SNIP\) Activation](#) article.

4. The next screen displays the unique email address assigned to your instance for Email Archiving. Forward emails to this email address to automatically archive the messages to Sugar.

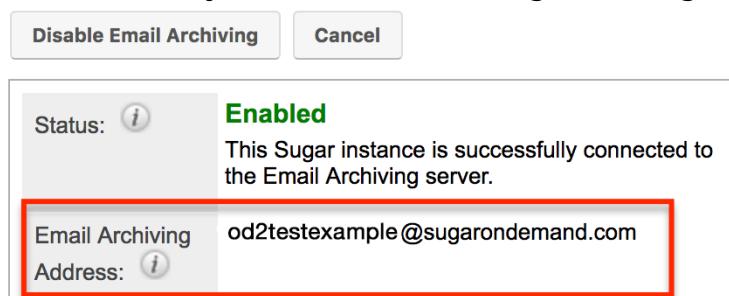

To begin using the email archiving service, please refer to the [Emails](#) documentation in the Application Guide. To turn off this feature, navigate to Admin > Email Archiving and click "Disable Email Archiving".

Note: If you disable and then re-enable Email Archiving, you will be assigned an archiving email address that is different than the one you were using before.

Inbound Email

Inbound Email allows external email to be pulled into Sugar. Inbound accounts can be configured as either [group email accounts](#) or [bounce email accounts](#). Group inbound accounts can be configured to create case records in Sugar or send

automatic replies to imported email. Prior to Sugar 7.10.x, you could enable the "Allow users to send emails using the "From" Name and Address as the reply-to address" option to allow users on teams who had access to the group email account to be able to select the "From" name and email address associated with the group email account when composing emails in Sugar. As of Sugar 9.0.x, you can instead create shared email accounts directly via Emails > Email Settings which allows groups of users belonging to the assigned team(s) to send outbound email messages using the same email account (e.g. support@example.com). For more information on creating shared email accounts, please refer to the [Emails](#) documentation. The following sections will cover how to use the Inbound Email module as well as the various actions and options available from within the module.

Note: The Check Inbound Mailboxes scheduler must be configured and running in order to retrieve inbound email messages in Sugar. For more information on setting up and configuring the inbound email scheduler, please refer to the [Schedulers](#) documentation.

Inbound Email Fields

The Inbound Email module contains a number of stock fields that come out-of-the-box with Sugar in order to configure inbound email accounts. The below definitions are the meanings for the available fields.

Field	Description
Assign To Teams	The Sugar team(s) assigned to the email record. Note: Users will only be able to see emails in group accounts as allowed by their team memberships.
Auto-Reply Template	Select an existing template or click "Create" to create a new one to send an automated response notifying email senders that you received their email. Note: If both Auto-Reply and Case Reply templates are selected, Sugar will respond to the sender with the Case Reply template only.
Create Case from Email	Select this option to create cases automatically from inbound emails. Only available for Group Accounts and defaults to not checked. For more information on creating cases

	via email, the distribution method, and case auto-reply, please refer to the Creating Cases From Email section.
Distribution Method	Only available if Create Case from Email is checked for a Group Account and allows you to select Round-Robin or Least-Busy for assigning the new cases.
From Address	Enter the email address (e.g. serviceinfo@example.com) that will appear as the "From" email address for automatic responses to imported email. Defaults to the email address from your user profile.
From Name	Enter the name (e.g. Service Info) that will appear as the "From" name for automatic responses to imported email. Defaults to your first and last name from your user profile.
Import Emails Automatically	Select this option to create email records automatically in Sugar for all incoming emails. Only available for Group Accounts and defaults to checked.
Leave Messages On Server	Select this option if you do not want to remove emails from the server when they are opened in Sugar. This will allow the messages to remain visible and appear unread in other email clients. Only available for Group Accounts and defaults to Yes.
Mail Server Address	The web address of the external email server from which emails will be imported in Sugar.
Mail Server Port	The communication port number used for connecting to the mail server.
Mail Server Protocol	The mail protocol used to communicate with the mail server. IMAP is the default selection and provides the best functionality with Sugar.
Monitored Folders	The folders in your external account that Sugar will monitor. Inbox is selected by default. To select one or

	more folders to monitor click "Select" and then pick the folders in your external account for Sugar to monitor.
Name	The name or designation of the account.
New Case Auto-Reply Template	Only available if Create Case from Email is checked for a Group Account and allows you to select or create an automated response template notifying email senders that a case has been created to resolve their issue. For more information on creating cases via email, the distribution method, and case auto-reply, please refer to the Creating Cases From Email section.
No Auto-Reply to this Domain	Enter the domain name to exclude a domain from receiving the automatic email response. It is common to specify your organization's domain to prevent auto-replies from being sent to your organization's members.
Number of Auto-responses	Set the maximum number of auto-responses to be sent to a unique email address during a period of 24 hours.
Password	Enter the password associated with the email address or username.
Reply-to Address	Enter the email address that will receive any replies to the auto-reply template. If left blank, replies will be sent to the From Address.
Reply-to Name	Enter the name that will be used to receive any replies to the auto-reply template. If left blank, replies will be sent to the From Name.
Sent Folder	Select a folder from your external account to store any email being sent from that account through Sugar.
Status	The current status of the account (i.e. Active, Inactive).
Trash Folder	Select a folder from your external account to be designated as the trash folder. Sugar will place deleted emails into this folder on your external

	account.
Use SSL	Check this box to force the connection and communication between Sugar and the mail server to use a secure socket layer of encryption.
Username	Enter the email address or username used to connect to the SMTP server.

Inbound Email Module Tab

The Inbound Email module tab is typically located on the navigation bar at the top of any Sugar screen after selecting "Inbound Email" from the Admin page. Once in the Inbound Email list view, click the triangle in the Inbound Email module tab to display the Actions and Recently Viewed menus. The Actions menu allows you to perform important actions within the module. The [Recently Viewed menu](#) displays the list of inbound email accounts you last viewed in the module.

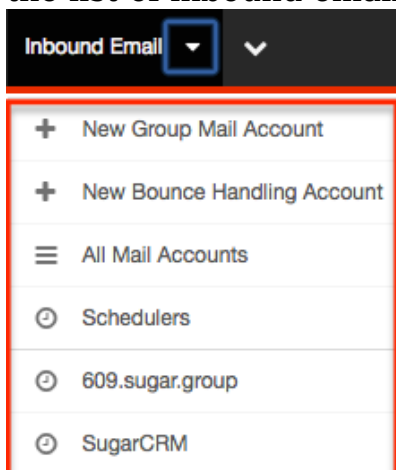

The Actions menu allows you to perform the following operations:

Menu Item	Description
New Group Mail Account	Opens the edit view layout to create a new Group Mail Account
New Bounce Handling Account	Opens the edit view layout to create a new Bounce Handling Account
All Mail Accounts	Opens the list view layout to display all inbound mail accounts
Schedulers	Opens the list view layout to search and display schedulers

Creating Inbound Email Accounts

There are various methods for creating inbound email accounts in Sugar. The full edit view layout opens when creating the inbound account directly from the Inbound Email menu and includes all of the relevant fields for your organization's accounts.

Creating Group Mail Accounts

One of the most common methods of Group Mail Account creation is via the New Group Mail Account option in the Inbound Email module tab. This opens up the edit view layout which allows you to enter all the relevant information for the group mail account. Please note that Group Mail Accounts will only import unread messages from the mail server.

Use the following steps to create a group mail account via the Inbound Email module:

1. Navigate to Admin > Inbound Email.
2. Click the triangle in the Inbound Email module tab and select "New Group Mail Account".

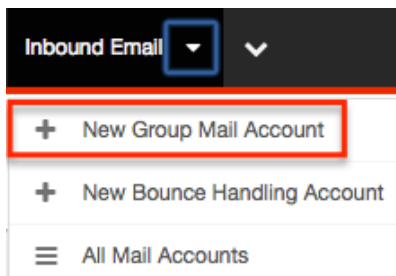

3. Enter appropriate values for the [fields](#) in the edit view layout.
Note: If your mail account is using Gmail, click "Prefill Gmail™ Defaults" to populate many fields with defaults to connect to Gmail.
4. Once the necessary information is entered, click "Save".

A screenshot of the "Mail Account Information" form. At the top, there are three buttons: "Save", "Cancel", and "Test Settings". The "Save" button is highlighted with a red rectangular box. Below the buttons, the form has a section titled "Mail Account Information" with a link "Prefill Gmail™ Defaults". The form fields are: "Name: *" with the value "Inbound Case Creation"; "Mail Server Address: *" with the value "imap.gmail.com"; "Mail Server Protocol: *" with a dropdown menu set to "IMAP"; "Mail Server Port: *" with the value "993"; and "Use SSL: (i)" with a checked checkbox.

Optionally, click "Test Settings" to verify your entries.

Creating Bounce Handling Accounts

One of the most common methods of Bounce Handling Account creation is via the New Bounce Handling Account option in the Inbound Email module tab. This opens up the edit view layout which allows you to enter in all the relevant information for the bounce handling mail account.

Use the following steps to create a bounce handling account via the Inbound Email module:

1. Navigate to Admin > Inbound Email.
2. Click the triangle in the Inbound Email module tab and select "New Bounce Handling Account".

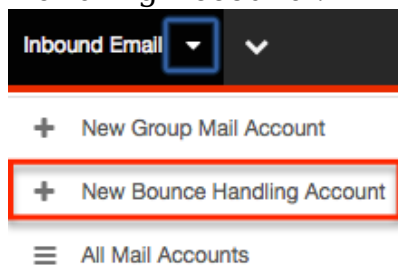

3. Enter appropriate values for the [fields](#) in the edit view layout.
Note: If your mail account is using Gmail, click "Prefill Gmail™ Defaults" to populate many fields with defaults to connect to Gmail.
4. Once the necessary information is entered, click "Save".

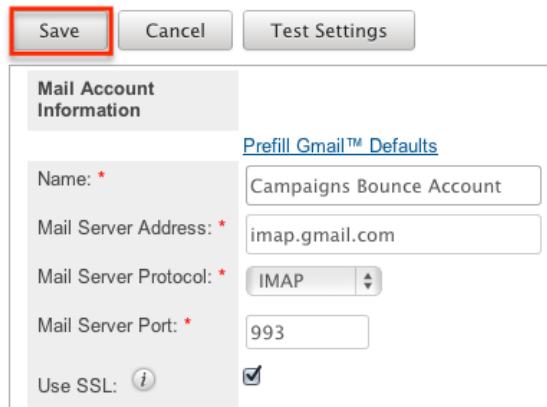
A screenshot of the 'Mail Account Information' form. At the top, there are three buttons: 'Save' (highlighted with a red box), 'Cancel', and 'Test Settings'. Below the buttons is a form section titled 'Mail Account Information'. It includes a link 'Prefill Gmail™ Defaults'. The form fields are: 'Name: *' with the value 'Campaigns Bounce Account'; 'Mail Server Address: *' with the value 'imap.gmail.com'; 'Mail Server Protocol: *' with a dropdown menu set to 'IMAP'; 'Mail Server Port: *' with the value '993'; and 'Use SSL: *' with a checked checkbox and an information icon.

Optionally, click "Test Settings" to verify your entries.

Note: The Campaigns module is not available for Sugar Serve users. For more information on license types and the functionality available for each, refer to the [User Management](#) documentation.

Creating via Duplication

You can also create a new group mail or bounce handling account by duplicating

an existing inbound email account record. The copy option is useful if the inbound email account you are creating has similar information to an existing inbound email account.

Use the following steps to create an inbound email account by duplicating an existing record:

1. Navigate to an inbound email account record's detail view.
2. Click "Copy".

609.sugar.group

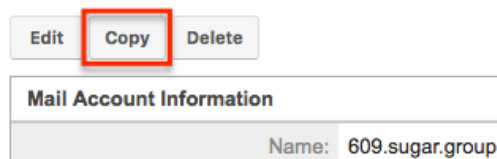

3. The displayed edit view is pre-populated with the original account's values. Update the necessary fields, then click "Save".

609.sugar.group

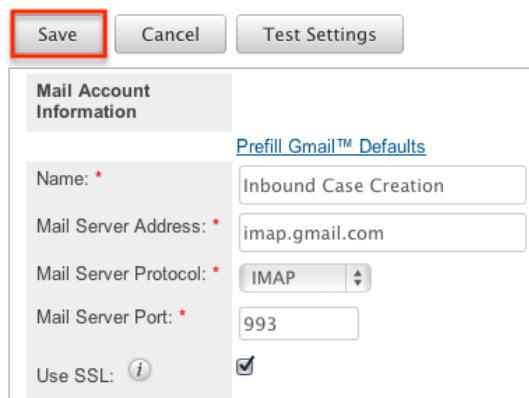

Viewing Inbound Email Accounts

There are various options available for viewing inbound account records in Sugar including via Inbound Email list view, detail view, and Last Viewed menu.

Viewing via List View

The Inbound Email list view displays all inbound account records. To access the list view, simply click the Inbound Email module tab. While list view shows key inbound account fields, you can click the account's name to open the record in detail view. For more information on viewing inbound accounts via list view, please refer to the [Inbound Email List View](#) section.

Viewing via Detail View

The Inbound Email detail view displays thorough inbound account information including all fields. The detail view can be reached by clicking an account record's link from anywhere in the application including from the Inbound Email list view. For more information on viewing inbound accounts via detail view, please refer to the [Inbound Email Detail View](#) section.

Viewing via Recently Viewed

As you work, Sugar will keep track of which inbound accounts you have recently viewed. Click the triangle in the [Inbound Email module tab](#) to see a list of the 3 records you most recently viewed in the module. Clicking the record's name within the list will open the record in detail view.

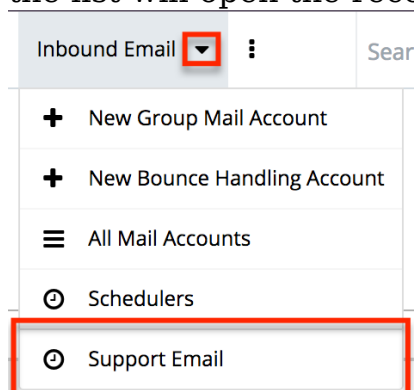

Inbound Email List View

The Inbound Email list view displays all inbound account records meeting the current search criteria and to which your user has access. You can view the basic details of each account within the field columns.

Modifying the Case Macro

The Case Macro field determines what distinct string Sugar will use to match emails to the Cases module. The Case Macro is on the Inbound Email list view and displays the current case macro string. By default, this string is set to [CASE:%1]. To customize it, you can change CASE to a different word, but you must preserve the rest of the string; for example, [TICKET NUMBER:%1].

Home

Save

Case Macro: [TICKET NUMBER:%1] Set the macro which will be parsed and used to link imported email to a Case.
Set this to any value, but preserve the "%1".

Click "Save" to preserve your changes.

Note: Incoming emails must have no space before the case number in order to be related to the existing case. For example, an email with the subject "[Case:1234]" will automatically be related to case number 1234 while an email with the subject "[Case: 1234]" will not.

Pagination

List view displays the current results broken into pages that you can scroll through rather than displaying potentially thousands of rows at once. To the right just below the case macro you can see which records of the total results set are currently being displayed. The two single-arrow Next and Previous buttons can be used to scroll through the records page-by-page. The two double-arrow First Page and Last Page buttons allow you to skip to the beginning or the end of your current results.

By default, Sugar displays 20 records per list view page, but administrators can change the number of records displayed via Admin > System Settings. For more information on changing the number of displayed records, please refer to the [System](#) documentation in the Administration Guide.

Save

Case Macro: [TICKET NUMBER:%1] Set the macro which will be parsed and used to link imported email to a Case.
Set this to any value, but preserve the "%1".

Inbound Email

Delete | Selected: 0

« < (1 - 5 of 7) > »

Checkbox Selection

You can perform several actions on inbound account records directly from the list view by first selecting the desired records. To select individual inbound account records on the Inbound Email list view, mark the checkbox on the left of each row. To select or deselect multiple inbound account records on the list view, use the options in the checkbox dropdown menu:

- **Select This Page** : Selects all records shown on the current page of

inbound account results.

- **Select All** : Selects all records across all pages of inbound account results.
- **Deselect All** : Deselects all records that are currently selected.

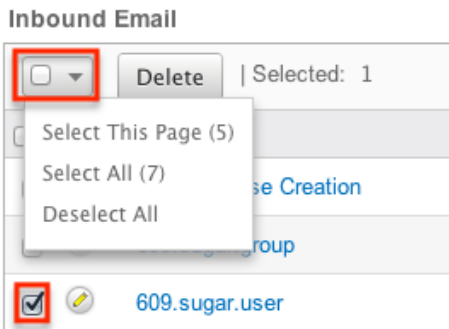

Action Buttons

The Actions menu to the right of the checkbox dropdown typically allows you to perform various actions on the currently selected records.

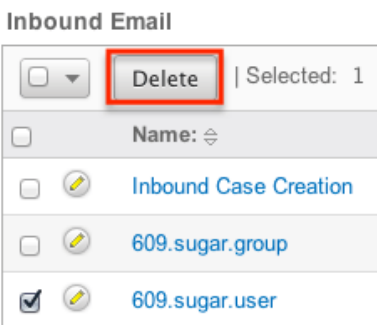

The only action available from the Inbound Email list view is the following operation:

Menu Item	Description
Delete	Delete one or more inbound accounts at a time

Column Sorting

List view provides the ability to sort all of the current results by a field column in either ascending or descending order. To sort by a field or switch the sort direction, click the column header noting that the fields which allow sorting will have a pair of arrows. The list view may be sorted by only one column at a time.

Inbound Email

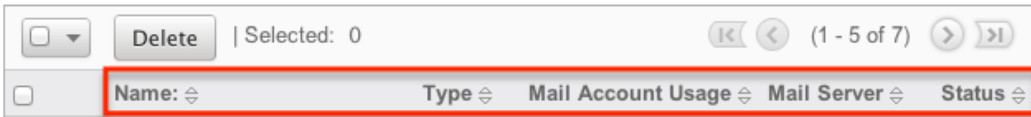

Inbound Email Detail View

The Inbound Email detail view displays thorough inbound account information including all inbound account fields which are grouped by default into the Mail Account Information and Advanced Setup panels. The detail view can be reached by clicking an inbound account record's link from anywhere in the application including from the Inbound Email list view.

Action Buttons

The Action Buttons on the top left of each inbound account's detail view allow you to perform various actions on the current record.

609.sugar.group

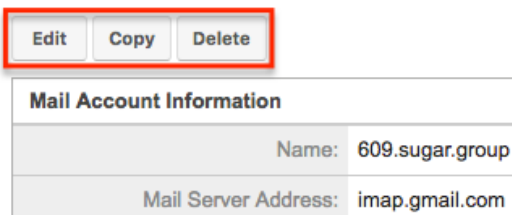

The action buttons allow you to perform the following operations:

Menu Item	Description
Edit	Edit this inbound account.
Copy	Duplicate this inbound email account.
Delete	Delete this inbound account.

Editing Inbound Email Accounts

Inbound accounts may be edited at any time to update or add information to the record. You can make changes to existing inbound account records via the Inbound Email edit view. Edit view is available within the Inbound Email module and includes all of the Inbound Email fields you should need.

Editing via Detail View

You can edit inbound accounts via the [detail view](#) by clicking the Edit button on the upper left of the page. Once the edit view layout is open, update the necessary fields, then click "Save" to preserve your changes.

609.sugar.group

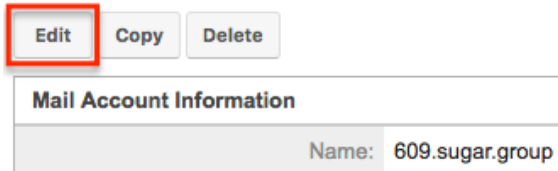

Editing via List View

You can edit inbound accounts via the [list view](#) by clicking the Pencil icon to the left of each inbound account's name. Once the edit view layout is open, update the necessary fields, then click "Save" to preserve your changes.

Inbound Email

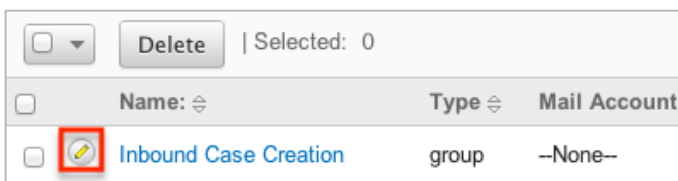

Deleting Inbound Email Accounts

If an inbound account record is invalid or should no longer appear in your organization's Sugar instance, it may be deleted from either the Inbound Email detail view or list view. Deleting via the detail view allows you to delete a single record while the list view allows for mass deleting multiple records at once. Deleting inbound account records will not delete the email imported from this account.

Deleting via Detail View

Use the following steps to delete an inbound account record via the detail view:

1. Navigate to an inbound email account record's detail view.
2. Click "Delete".

609.sugar.group

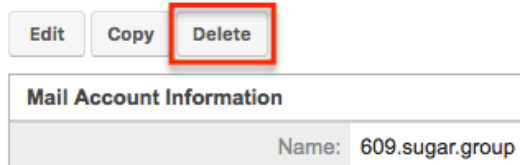

3. A pop-up message will display asking for confirmation. Click "Ok" to proceed.

Mass Deleting via List View

Use the following steps to delete one or more inbound email account records via the list view:

1. Navigate to the Inbound Email list view by clicking the Inbound Email module tab.
2. Select the desired inbound email account records individually or by using the checkbox dropdown's options.
3. Click "Delete".

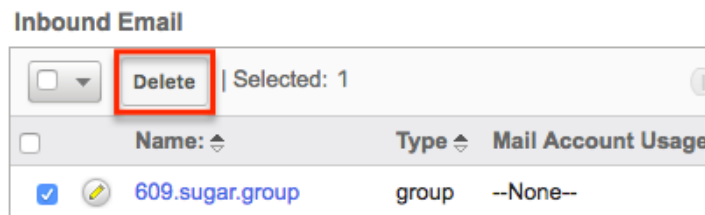

4. A pop-up message will display asking for confirmation. Click "Ok" to proceed.

Due to PHP memory limitations on the server, there may be occasions when the application times out while deleting a large number of inbound account records. If you encounter an error when performing this action, we recommend selecting the records in smaller batches.

Creating Cases From Email

To create a case via email, simply send an email to a group inbound email account that has the case creation option selected. The subject and description of the case are populated with the subject and body of the email respectively. The new case is assigned to the team defined in the inbound email account record and the case can be assigned to a specific user in that team based on two rules:

- **Round-Robin** : Sugar distributes cases evenly among all users within the team.
- **Least-Busy** : Sugar distributes cases to the least busy user within the

team. Least busy is defined by the person with the least number of unread emails assigned to them.

Note: Case assignment is distributed to all members of the specified team, but excludes any inherited members of the team due to the "Reports To" structure. For more information on teams and the Reports To structure, please refer to the [Team Management](#) and [User Management](#) documentation in the Administration Guide.

Cases created from email are automatically related to contact and account records that match the email address in the From field of the email. If a case auto-reply template is specified, the sender of the email will receive an email based on the template selected. The response contains the system-generated case number formatted according to the case macro as a subject line. The body of the email displays below the template text. The case auto-reply also ignores the "No Auto-Reply to this Domain" setting.

Note: If both the Auto-Reply and Case Auto-Reply templates are selected, Sugar will respond to the sender with the Case Auto-Reply template only.

Email Queue

The Email Queue option in Admin is where Sugar administrators can monitor and perform actions on queued email. When sending a campaign, the emails are not sent immediately but are instead queued to be sent. Each queued email has a "Send On" date and time set by the campaign they are sent from. The scheduler "Run Nightly Mass Email Campaigns" takes the queued emails that are ready to be sent based on this date and time and sends them in batches. If an email fails to send from the queue for any reason it will be flagged as a send attempt and, by default, Sugar will not attempt to send that email for another 24 hours. Once Sugar reaches six failed attempts to send an email it will be deleted from the queue. In order to send a failed email sooner than the default 24 hours, you can perform a [mass update](#) to reset the In Process field. For more troubleshooting information, refer to the [Troubleshooting Campaigns Failing to Send From Email Queue](#) article. This section will cover how to use the email queue as well as the various actions and options available from within the email queue.

Note: The Campaigns module is not available for Sugar Serve users. For more information on license types and the functionality available for each, refer to the [User Management](#) documentation.

Viewing via List View

The email queue list view displays all queued email records meeting the current search criteria. To access the list view, simply click the Email Queue link on the Admin page. List view shows key email fields including links to the Campaign, Recipient, and Marketing Message records. For more information on viewing queued email via list view, please refer to the [Email Queue List View](#) section.

Searching Queued Email

The email queue list view includes a Basic and Advanced Search to help you locate records easily and effectively in a module-specific manner. Once the search is performed, the relevant results will be displayed in the Email Queue list view below. Please note that Sugar automatically appends the wildcard character (%) to the end of your search phrase. This allows the system to retrieve all records that start with the keyword entered in the search. If you would like to broaden the search, you can use the wildcard at the beginning of your text as well (e.g. %services). This will pull up any record that has the word "services" in the name, regardless of how it starts or ends.

For more information on using the various search methods as well as how wildcards are used in the different methods, please refer to the [Search](#) documentation.

Basic Search

Basic search offers a few, commonly used fields for a simplified search experience. From the Basic Search panel, you can click "Advanced Search" to access additional search functionality as needed.

The buttons and checkboxes available in Basic Search panel have the following functions:

- **Search** : Click the Search button or press your Return/Enter key to perform the search.
- **Clear** : Click the Clear button to clear all criteria from the searchable fields.

Email Queue



Once the search is complete, the relevant results will populate in the list view below the search panel. To see all queued email records to which you have access, simply click "Clear" and then "Search" to perform a blank search with no filters.

Advanced Search

Advanced Search offers a more in-depth search experience than Basic Search including additional fields, layout options, and saved search capability. From the Advanced search panel, you can click "Basic Search" for simplified searching.

The buttons, checkboxes, and dropdowns available in Advanced Search have the following functions:

- **Search** : Click the Search button or press your Return/Enter key to perform the search.
- **Clear** : Click the Clear button to clear all criteria from the searchable fields.
- **Layout Options** : Use the expandable Layout Options section to configure your list view. For more information, please refer to the [Layout Options](#) section of the Search documentation.
- **Saved Searches** : Save, recall, update, and delete searches that you use often. For more information, please refer to the [Saved Search](#) section of the Search documentation.

Email Queue

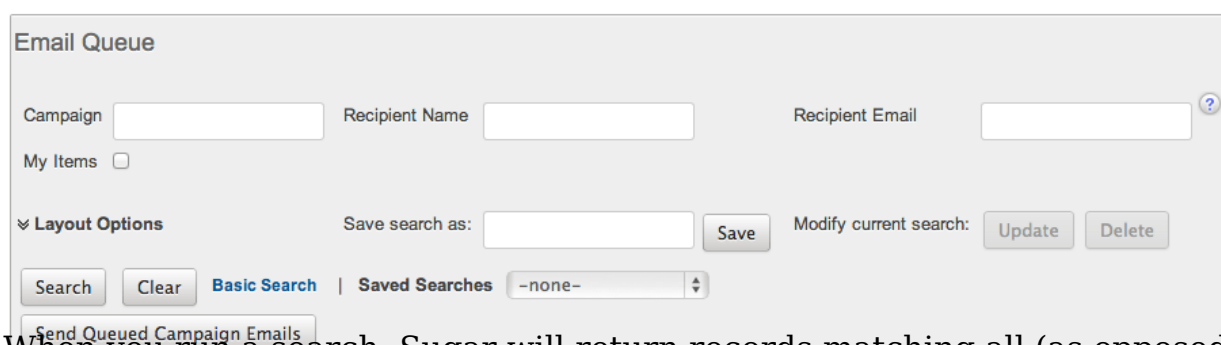

When you run a search, Sugar will return records matching all (as opposed to any) of the fields for which you have given a value. For example, if you enter a campaign name to search and a recipient name, Sugar will only return queued email records with matching both fields. Once the search completes, the relevant results will populate in the list view below the search panel. To see all queued email records to which you have access, simply click "Clear" and then "Search" to perform a blank search with no filters.

Email Queue List View

The Email Queue list view displays all queued email records meeting the current search criteria and to which your user has access. You can view the basic details of each email within the field columns.

You have the option to change what fields are displayed in list view by configuring your layout options in the Advanced Search. For more information on configuring

your list view, please refer to the [Layout Options](#) section of the Search documentation.

Pagination

List view displays the current search results broken into pages that you can scroll through rather than displaying potentially thousands of rows at once. To the right just below the search panel, you can see which records of the total results set are currently being displayed. The two single-arrow Next and Previous buttons can be used to scroll through the records page-by-page. The two double-arrow First Page and Last Page buttons allow you to skip to the beginning or the end of your current results.

By default, Sugar displays 20 records per list view page, but administrators can change the number of records displayed via Admin > System Settings. For more information on changing the number of displayed records, please refer to the [System](#) documentation in the Administration Guide.

Email Queue

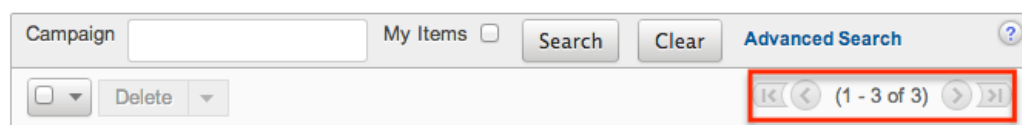

Checkbox Selection

You can perform several actions on queued email records directly from the list view by first selecting the desired records. To select individual queued email records on the Email Queue list view, mark the checkbox on the left of each row. To select or deselect multiple queued email records on the list view, use the options in the checkbox dropdown menu:

- **Select This Page** : Selects all records shown on the current page of results.
- **Select All** : Selects all records in the current search results across all pages of results.
- **Deselect All** : Deselects all records that are currently selected.

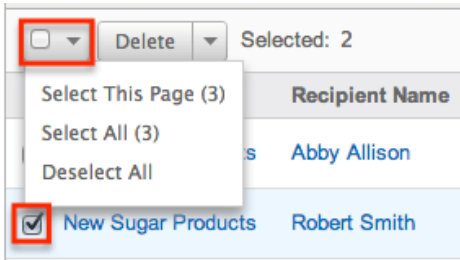

Actions Menu

The Actions menu to the right of the checkbox dropdown allows you to perform various actions on the currently selected records.

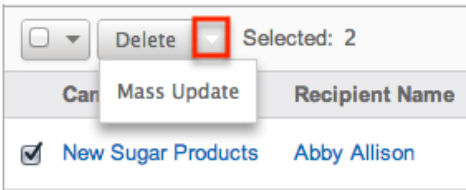

The options in the Actions menu allow you to perform the following operations:

Menu Item	Description
Delete	Delete one or more queued emails at a time
Mass Update	Mass update one or more queued emails at a time

Column Sorting

List view provides the ability to sort all of the current search results by a field column in either ascending or descending order. To sort by a field or switch the sort direction, click the column header noting that the fields which allow sorting will have a pair of arrows. The list view may be sorted by only one column at a time. You can also set a default order-by column using the layout options in Advanced Search. For more information on setting a default column sort, please refer to the [Layout Options](#) section of the Search documentation.



Deleting Queued Email

If a queued email is invalid or should no longer be sent, it may be deleted from the

list view. The list view allows for mass deleting multiple records at once. Deleting queued emails will not delete the campaign or target, but will remove the instance of this email so it will not be sent.

Mass Deleting via List View

Use the following steps to delete one or more queued email records via the list view:

1. Navigate to the Email Queue list view by clicking the Email Queue link on the Admin page.
2. Use the [Basic](#) or [Advanced Search](#) to find the queued email records you wish to delete.
3. Select the desired records individually or using the [checkbox dropdown's](#) options.
4. Choose "Delete" from the Actions menu.

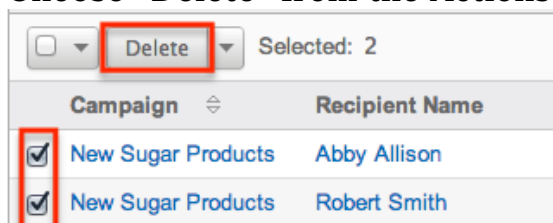

5. A pop-up message will display asking for confirmation. Click "Ok" to proceed.

Due to PHP memory limitations on the server, there may be occasions when the application times out while deleting a large number of queued email records. If you encounter an error when performing this action, we recommend selecting the records in smaller batches.

Mass Updating Queued Email

Mass Updating allows users to make the same change to multiple queued email records at once from the Email Queue list view. Currently, only fields with the data type of date, datetime, dropdown, multiselect, and radio may be altered during a mass update. Due to the PHP memory limitations on the server, there may be occasions when the application times out while mass updating a large number of queued email records. If you encounter an error when performing this action, we recommend selecting the records in smaller batches.

Use the following steps to mass update queued email records from the list view:

1. Navigate to the Email Queue list view by clicking the Email Queue link on the Admin page.

2. Use the list view's [Basic](#) or [Advanced Search](#) to find the queued email you wish to modify.
3. Select the desired records individually or using the [checkbox dropdown's](#) options.
4. Choose "Mass Update" from the Actions menu.

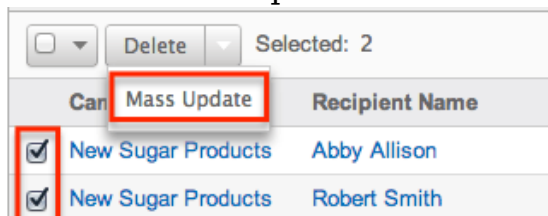

5. Scroll to the Mass Update panel and set values for the fields you wish to alter.

The 'Mass Update' panel contains the following elements:

- Send Date:** A text input field with a calendar icon and the format *(mm/dd/yyyy)*.
- Queued Date:** A text input field with a calendar icon and the format *(mm/dd/yyyy)*.
- In Process:** A dropdown menu currently showing *-none-*.
- Buttons:** 'Update' (highlighted in red), 'Cancel', and 'Send Queued Campaign Emails'.

Note: After an email has failed to send, setting In Process to "No" will flag the email to attempt to send again. Otherwise, the email will not attempt to be sent again until 24 hours have passed. Optionally set the Send Date to configure when the email should be attempted again.

6. Click "Update" to save the changes to all of the currently selected queued email records.

Sending Queued Email

Email in the queue will be automatically be sent out in batches by the "Run Nightly Mass Email Campaigns" scheduler. For more information on setting up and configuring scheduler, please refer to the [Schedulers](#) documentation in the Administration Guide. Alternatively, you can manually send a batch of emails in the queue. The amount of queued email that will be sent is equal to the "Number of emails sent per batch" value specified in the [Campaign Email Settings](#).

Note: The Campaigns module is not available for Sugar Serve users. For more information on license types and the functionality available for each, refer to the [User Management](#) documentation.

Use the following steps to manually send a batch of queued emails from the list view:

1. Navigate to the Email Queue list view by clicking the Email Queue link on

the Admin page.

2. Choose "Send Queued Campaign Emails" from below the list view.

Email Queue

The screenshot shows a web interface for managing an email queue. At the top, there is a search bar labeled 'Campaign' and a 'My Items' checkbox. Below this is a table with two columns: 'Campaign' and 'Recipient Name'. The table contains three rows of data, each with a checkbox on the left. Below the table, there is a 'Delete' button and a 'Send Queued Campaign Emails' button, which is highlighted with a red rectangular box.

Campaign	Recipient Name
<input type="checkbox"/> New Sugar Products	Abby Allison
<input type="checkbox"/> New Sugar Products	Robert Smith
<input type="checkbox"/> New Sugar Products	Chris Olliver

Delete

3. Sugar will then send a batch of queued email whose Send On date and time is equal to now or in the past.

Note: If an email fails to send it will not be tried again for 24 hours.

Selecting specific records and searching for specific records will not determine which queued emails will be sent. This process will send a batch of emails that are queued to be sent in order by the Send On field. For more information on setting the batch amount, please refer to the [Campaign Email Settings](#) section.

Note: If your batch size is set high and you have a lot of queued email, this process can take a while to run through a single batch.

Last Modified: 2020-03-10 02:25:46

Developer Tools

Overview

The Developer Tools section of Sugar's Admin page contains various configuration menus that help you customize your instance to best suit your organization's needs. Developer Tools allow you to edit the look, feel, and functionality of your instance, including adding fields, changing layouts, adding automated processes, and creating entirely new modules.

The Developer Tools section contains the following menus:

Menu	Description
Studio	Modify fields, relationships, and layouts for existing modules
Module Builder	Create new modules to be deployed into this instance or exported to other Sugar instances
Module Loader	Upload and manage customization packages to your instance, such as additional modules or third-party integrations
Sugar Portal	Configure your Sugar Portal
Workflow Management	Manage automated processes in Sugar to optimize and streamline your company's business process
Rename Modules	Update the name of each module within Sugar
Display Modules and Subpanels	Hide or display modules and subpanels across the application
Configure Navigation Bar Quick Create	Configure which modules appear in the Quick Create menu on the navigation bar
Configure API Platforms	Manage platform identifiers for custom API integrations
Dropdown Editor	Manage dropdown lists to add new lists or edit existing lists

Studio

Studio enables administrators to customize stock or custom modules by modifying fields, page layouts, and more. This allows Sugar to be modified to ideally fit your organization's needs and terminology. Please note that only users with administrator or developer access have the ability to make changes via Admin > Studio. For more information on how to utilize Studio, please refer to the [Studio](#) documentation.

Module Builder

Module Builder enables administrators to create, deploy, and maintain custom modules in Sugar. For your convenience, the custom modules are based on templates such as Basic, Person, Company, etc. Modules can then be deployed within your instance of Sugar so that users can utilize the new module in their daily process. In addition, modules can be exported for additional development or published and then imported to other Sugar instances. For more information on using Module Builder, please refer to the [Module Builder](#) documentation.

Module Loader

Module Loader is used to import packages into Sugar that make changes to core files. Examples of module-loadable packages include Sugar custom modules that were created in Module Builder, language packs, third-party integrations, or any other type of file that would make changes to Sugar's core file system. Module Loader provides a portal within the application where zip files can be easily uploaded and then installed. For more information on how to use Module Loader, please refer to the [Module Loader](#) documentation.

Sugar Portal

Sugar Portal is a powerful tool which allows Sugar users to interact with customers and share information related to multiple modules. Your customers can log into the portal and view information in your Sugar instance as well as submit [cases](#), [bugs](#), and review [knowledge base](#) articles. The information allowed and viewable in the portal can be updated and restricted by Sugar users as allowed by team membership, user access type, and assigned roles. Administrators can configure portal settings, the look and feel of the theme, and the layout configurations via Admin > Sugar Portal. For more information on configuring the portal, please refer to the [Sugar Portal](#) documentation.

Note: The Cases and Bugs modules are not available to Sugar Sell users. For more information on license types and the functionality available for each, refer to the [User Management](#) documentation.

Workflow Management

Sugar's Workflow functionality allows administrators to configure cause and effect type actions throughout Sugar and across multiple modules. Workflows can be used to update fields, send emails, or create records once certain sets of conditions are met. Workflows are a great way to configure automated processes within Sugar so that users do not need to remember manual steps and instead can focus

on their primary tasks and job responsibilities. Administrators can create and manage workflows via Admin > Workflow Management. For more information on workflows, please review the [Workflow Management](#) documentation.

Rename Modules

Depending on your business needs, it may be necessary to alter the display label to make the module's name (e.g. Contacts, Accounts, etc.) align with your various business components. Administrators can easily rename modules via Admin > Rename Modules. When editing a name, you are given the option to update both the singular and plural version of the word. This change will be reflected globally across Sugar so that every use of the given module name is updated to your preference, seamlessly to all users. You can also use the language dropdown list at the top of the page to rename the modules to a language other than English.

The following steps cover renaming the Contacts module as an example:

1. Navigate to Admin > Rename Modules.
2. Locate the module you wish to change and click the Pencil icon to the left of the module's name.

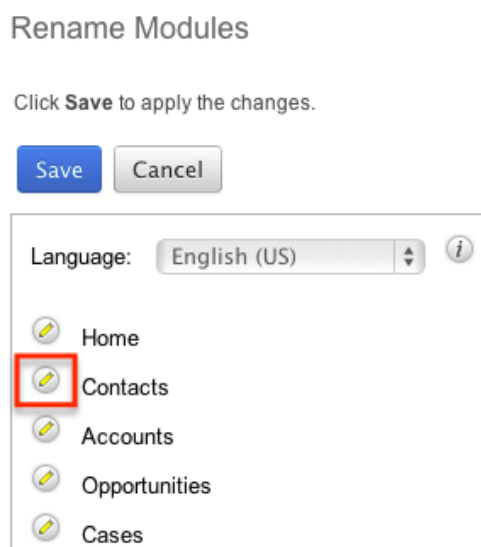

3. Enter a new singular and plural name for the module then click the Pencil icon again to close the text boxes.

Rename Modules

Click **Save** to apply the changes.

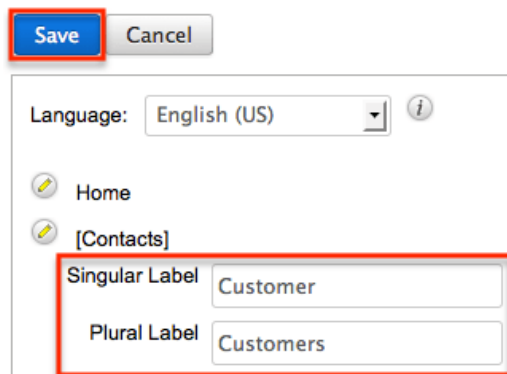

Save Cancel

Language: English (US) ⓘ

Home

[Contacts]

Singular Label Customer

Plural Label Customers

4. Click "Save" to deploy your changes across your instance.

Display Modules and Subpanels

Administrators have the ability to control which modules and subpanels will appear in their instance via Admin > Display Modules and Subpanels. This option is useful as any unnecessary module(s) and subpanel(s) can be hidden to prevent users from accessing it. Please note that not every module and subpanel in Sugar is enabled by default when initially installed.

Once the "Display Modules and Subpanels" page is open, you will see the Displayed Modules, Hidden Modules, Displayed Subpanels, and Hidden Subpanels columns. To configure which modules are displayed on the navigation bar, drag and drop the module from the Hidden Modules column to the Displayed Modules column. To hide a module, simply drag and drop the module from the Displayed Modules column to the Hidden Modules column. To configure which subpanels appear in modules, drag and drop the module from the Hidden Subpanels column to the Displayed Subpanels column. To hide a subpanel, simply drag and drop the module from the Displayed Subpanels column to the Hidden Subpanels column. After making the necessary changes, click "Save" at the top of the page to deploy your changes or "Cancel" to revert back to your previous settings.

Please note that if a hidden module is related to a module that is visible in Sugar, it will display as a subpanel in the record view (for Sidecar modules) or detail view (for Legacy modules) of the related module. In addition, hidden modules continue to be available to users when viewing, creating, and managing reports via the Reports module. When a subpanel is hidden, users cannot view any related records from the record view (for Sidecar modules) or detail view (for Legacy modules) of the related module.

Display Modules and Subpanels

Drag and Drop the names of the modules below to set them to be displayed or hidden

Allow users to select modules to appear in the navigation bar i

Displayed Modules	Hidden Modules
Accounts	Contracts
Contacts	
Opportunities	
Leads	
Calendar	
Reports	
Quotes	
Quoted Line Items	
Documents	
Web Logic Hooks	
Emails	

Displayed Subpanels	Hidden Subpanels
Contacts	Bug Tracker
Leads	Quoted Line Items
Accounts	Contracts

Users have the option to hide and display modules per their viewing preference via the [User Profile](#). The list of available modules to display and hide in a user's account is based on the modules in the Displayed Modules column of the Display Modules and Subpanels page. To disable the users' ability to modify which modules are hidden or displayed on their navigation bar, uncheck the Allow users to select modules to appear in the navigation bar checkbox above the Displayed and Hidden Modules columns.

If you wish to prevent certain users from accessing specific modules in Sugar, you can keep the module enabled globally but assign a role to the user. For more information on creating and assigning roles, please refer to the [Role Management](#) documentation.

Configure Navigation Bar Quick Create

The Quick Create menu allows users to easily create new records from anywhere in Sugar. Simply click the quick-create button on the upper right of any Sugar page to access the menu. Administrators can easily configure the Quick Create menu via Admin > Configure Navigation Bar Quick Create menu to control which

modules are enabled/disabled, as well as the order the modules will appear in the menu.

Once the "Configure Navigation Bar Quick Create" page is open, you will see the Enabled Modules and Disabled Modules columns. Modules that appear within the Enabled Modules column will display in the Quick Create menu. To enable a module to be displayed in the Quick Create menu, drag and drop the module from the Disabled Modules column to the Enabled Modules column. To disable a module, simply drag and drop the module from the Enabled Modules column to the Disabled Modules column. You can also change the order of the modules as they appear in the Quick Create menu by dragging and dropping the modules up-and-down within the Enabled Modules list. After making the necessary changes, click "Save" at the top of the page to deploy your changes or "Cancel" to revert back to your previous settings.

Note: The Quick Create menu can display a maximum of 10 modules at one time.
[Configure Navigation Bar Quick Create](#)

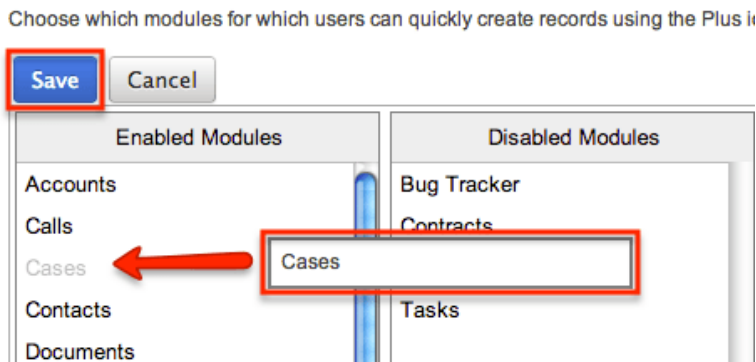

Configure API Platforms

Developers use the platform parameter to distinguish their custom platform from other clients when using the Sugar API. For example, when a user accesses Sugar via the desktop client and the mobile client simultaneously without being logged out of either, it is because the API recognizes that they are different platforms due to their unique platform identifiers. The platform identifier also makes it easy for a Sugar administrator to configure which API platforms are allowed to access their instance via Admin > Configure API Platforms.

Note: To learn more about platform identifiers, please refer to the [Dev Blog](#) in SugarClub.

The API Platforms panel is a list of client IDs that have been given permission to interact with your Sugar instance. The panel will automatically display some

standard platform identifiers required by every Sugar instance. The stock API platforms listed in the following table cannot be removed and must not be reused as platform identifiers for a custom integration.

API Platform Identifier	Platform/Client
base	Sugar desktop client (default platform)
mobile	Sugar Mobile app
portal	Sugar Portal (Enterprise, Ultimate, Sell, Serve)
opi	Sugar Plug-in for Microsoft Outlook 2.x
lpi	Sugar Plug-in for IBM Notes

To allow a new integration for your Sugar instance, find the package's platform parameter, enter it in the text box below the API Platforms panel, and then click "Add". You may need to ask your developer to check the `.custom/clients/platforms.php` file for this information. To remove any custom API platforms from the list, click the Remove icon next to the API platform identifier that you wish to remove. Upon removing the platform, all integrations that relied upon it will stop working.

Configure API Platforms

The screenshot shows a dialog box titled "API Platforms". At the top left, there are "Save" and "Cancel" buttons. The main area contains a list of platform identifiers: *base*, *mobile*, *portal*, *opi*, *lpi*, and *my_custom_integration*. Each identifier is on a separate line. To the right of *my_custom_integration* is a small red square with a white minus sign, used for removal. Below the list is a text input field and an "Add" button. At the bottom left, there are "Save" and "Cancel" buttons.

Alternatively, developers may choose to create a module loadable package to add custom identifier(s) via Sugar's Module Loader tool. To remove platform identifiers that were added via Module Loader, simply uninstall the package. More

information on adding platform identifiers via Module Loader can be found on the [Dev Blog](#) in SugarClub and the [Platforms](#) documentation in the Developer Guide.

Dropdown Editor

The Dropdown Editor allows administrators to view, modify, and create dropdown lists which can be added as fields in Sugar. Since dropdown lists are not module specific, they are stored and managed through the Dropdown Editor. Please note that the dropdown list can only be associated with dropdown, multiselect, and radio-type fields via Admin > Studio. For more information on associating dropdown lists to the different field types, please refer to the [Studio](#) documentation.

You can restrict which dropdown values are available to users based on their roles. For more information about role-based visibility, please refer to the [Editing Role-Based Availability](#) section of this page.

Certain dropdown lists cannot be edited via the Dropdown editor as they are controlled by a separate area (e.g. Contract Types, Releases, etc.) of the Admin page. These include dropdown lists for the [Forecasting](#), [Bug Tracker](#), [Contracts](#), and [Products and Quotes](#) modules. Please refer to the appropriate sections of the Administration Guide for more information regarding the fields and how they can be edited.

Adding Dropdown Lists

Dropdown lists can be created at any time and added to a Dropdown type field via [Studio](#). When creating a list, please keep in mind that this list is not module specific, so be sure to properly name your list and any dropdown options to avoid any confusion in the future.

If desired, you can restrict which dropdown values are available to users based on their roles. For more information about role-based visibility, please refer to the [Editing Role-Based Availability](#) section of this page.

Use the following steps to create a dropdown list via Dropdown Editor:

1. Navigate to Admin > Dropdown Editor.
2. Click the Add Dropdown button, which is located above the list of existing dropdown lists.



3. Enter a name for your dropdown list in the Name field (e.g. "account_manager_list").
 - **Note:** The name must be alphanumeric and use the underscore character for spaces.

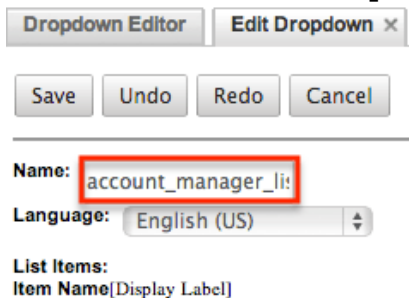

4. To create the items that will appear in your dropdown list, enter an "Item Name" and a "Display Label". Click "Add" once you have populated both fields to add the value to the dropdown list.
 - The item name is the backend system name for the list item and must be alphanumeric. An underscore or a period can be used for the item name.
 - The display label defines what will be displayed in the actual dropdown. Please note that there are no character restrictions when entering the display label. Click "Add" once you have populated both fields to add the value to the dropdown list.

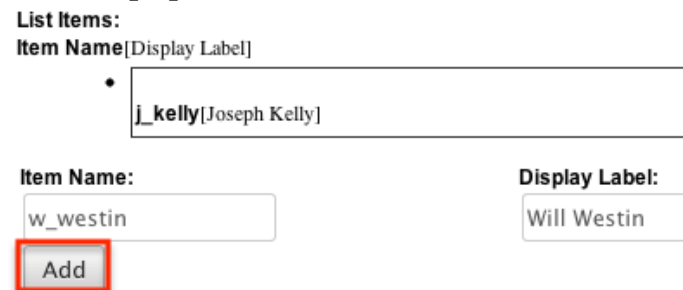

5. Once all values have been added to your dropdown list, you can click one of the sort options to rearrange the values as desired. Lists can be sorted alphabetically in ascending or descending order based on the display label. You can also sort the list manually by dragging and dropping the values up-and-down the list.

Item Name:

Display Label:

Add

Sort Ascending Sort Descending

- Click "Save" at the top of the screen to complete and add your dropdown list. You will be directed back to the main dropdown editor page once the save completes.

Dropdown Editor Edit Dropdown ×

Save Undo Redo Cancel

Name:

Viewing Dropdown Lists

The Dropdown Editor displays all existing dropdown lists in two separate sections (Dropdowns list, Dropdown Editor) on the page. The Dropdowns list to the left of the page displays the dropdown lists in alphabetical order. The Dropdown Editor tab displays the dropdown lists in columns and allows you to view more of the lists at once instead of scrolling down a single list.

Dropdowns

- Elastic_boost_options
- account_manager_list
- account_type_dom
- activity_dom
- available_language_dom
- bopselect_type_dom
- bselect_type_dom
- bug_priority_dom
- bug_resolution_dom

Dropdown Editor

[Home](#) | Dropdown Editor

Add Dropdown

Elastic_boost_options	account_manager_list
activity_dom	available_language_dom
bselect_type_dom	bug_priority_dom
bug_status_dom	bug_type_dom
call_status_dom	campaign_status_dom
campainglog_activity_type_dom	campainglog_target_type_dom

Once you locate the dropdown list you are looking for, click the list's name to open the Edit Dropdown tab to view and edit the list. The Edit Dropdown tab displays the name, the set language for the list, list values, and the item name. The list will be ordered as they appear in the dropdown list when added as a field to a layout. You can reorder the list if you wish by dragging and dropping the items into the desired positions.

Dropdown Editor Edit Dropdown x

Save Undo Redo Cancel

Name: account_type_dom
Language: English (US)

List Items:

Item Name	Display Label
-blank-	[-blank-]
Analyst	[Analyst]
Competitor	[Competitor]
Customer	[Customer]

If your organization uses Sugar in languages other than English, Sugar can display translated dropdown lists for each language used. For example, Sugar will display French dropdown items when a user is logged into Sugar in French. You must provide the translations for each language by specifying display labels for each dropdown item. First, finalize your list's items by [adding or removing items](#); the item names (a.k.a. database values) and order of items will be consistent across all languages. Choose the desired language in the Language dropdown above the list. Then, click the pencil icon for each item and enter a translated display label. When all labels have been translated, click "Save" to preserve your changes. After saving, the list will automatically be displayed in English, but you can change the Language dropdown again to check your labels.

Dropdown Editor Edit Dropdown x

Save Undo Redo Cancel

Name: account type dom
Language: English (US) ✓
Български
Česky
Dansk
Deutsch

Editing Dropdown Lists

Dropdown lists can easily be modified via the Dropdown Editor by selecting the specific dropdown list which opens the edit layout. You can reorder the items in the list, add new values, remove unnecessary values, change the display label for a value, or change the display label language.

If desired, you can restrict which dropdown values are available to users based on their roles. For more information about role-based visibility, please refer to the [Editing Role-Based Availability](#) section of this page.

Please note that the name of the dropdown list cannot be changed once created. Also, dropdown lists cannot be deleted since they can span multiple modules in Sugar and cause important data to be lost if removed in error. Once the necessary modifications have been made, click "Save" on the upper right to preserve the changes made.

To sort the list alphabetically, you can simply click the Sort Ascending or Sort Descending button on the bottom left of the tab view. Please note that the sorting is based on the display label. You can also reorder the items in your list, by dragging and dropping the items into the desired position.

List Items:

Item Name	Display Label
-blank-	[-blank-]
Analyst	[Analyst]
Customer	[Customer]
Competitor	[Competitor]
Integrator	[Integrator]
Investor	[Investor]
Partner	[Partner]
Press	[Press]
Prospect	[Prospect]
Reseller	[Reseller]
Other	[Other]



Item Name: Display Label:

Add

Sort Ascending Sort Descending

To add a new value, enter an item name and corresponding display label below the list of existing values then click "Add". Please note that the item name is the back-end system name and must be alphanumeric without any special characters other than an underscore or a period. The text in the display label defines how the value will be displayed in the dropdown list when viewed in the user interface. Please note that there is no character restriction for the display label.





List Items:
Item Name[Display Label]

- j_kelly [Joseph Kelly]  

Item Name: **Display Label:**

To remove a value from the list, click the Minus icon to the far right of the item row. Once deleted, the item will show a strike through and will be removed from the list once saved.

List Items:
Item Name[Display Label]

- ~~j_kelly [Joseph Kelly]~~  
- ~~w_westin [Will Westin]~~  

The item name of a dropdown value cannot be edited, but you can update the display label via the Dropdown Editor. Simply locate the value in the list then click the Pencil icon to the far right of the item row. Enter the new value into the open text box then click anywhere on the page to close the edit.

List Items:
Item Name[Display Label]

- w_westin  
- j_kelly [Joseph Kelly]  

Editing Sales Stages

The Revenue Line Items module contains two fields that function unlike other fields in Sugar. When the Sales Stage dropdown field is updated, the corresponding probability is automatically populated in the Probability (%) field. This is a unique function of the Revenue Line Items module. These two fields use the two dropdown lists, "sales_stage_dom" and "sales_probability_dom". Both dropdown lists have the same item name for all values but different display labels. The sales_stage_dom list is associated with the Sales Stage field and displays the various sales stages (e.g. prospecting, qualification, closed won, etc.). The sales_probability_dom list is associated with the Probability (%) field and displays the corresponding probability value (e.g. 10, 20, 100, etc.) for each sales stage.

When any changes are made to the sales_stage_dom list, you must consider the sales_probability_dom list as well to ensure the relationship between the two fields remains intact. For example, if you add a new sales stage (e.g. Item Name: "review_stage", Display Label: "Review Stage") to the sales_stage_dom list then you must add a corresponding probability (e.g. Item Name: "review_stage", Display Label: "50") to the sales_probability_dom list in order for it to populate properly in the revenue line item. The two lists' item names and order must match.

The Opportunities module's Status field uses the sales_status_dom list. Modifying this list is not recommended as the values in this dropdown are tied to the Revenue Line Item module's Sales Stage field. Making changes to this dropdown list's item names via code or Studio can cause unexpected behavior. For more information regarding the Status field, please refer to the [Opportunities](#) documentation.

Note: The dropdown lists "sales_stage_dom" and "sales_probability_dom" must have "Closed Won" and "Closed Lost" as item names in order for the Forecasts module to function correctly. Please ensure any changes to these lists does not remove or change the item name for these two options.

Note: The Opportunities, Revenue Line Items, and Forecasts modules are not available to Sugar Serve users. For more information on license types and the functionality available for each, refer to the [User Management](#) documentation.

For sales_stage_dom list:

Name: sales_stage_dom

Language:

List Items:

Item Name[Display Label]

-
-
-
-

For sales_probability_dom list:

Name: sales_probability_dom

Language: English (US)

List Items:

Item Name[Display Label]

- **Prospecting** [10]
- **Qualification** [20]
- **Needs Analysis** [25]
- **Value Proposition** [30]

Users can create similar logic for custom fields using Sugar Logic in [Studio](#).

For sales_status_dom list:

Name: sales_status_dom

Language: English (US)

List Items:

Item Name[Display Label]

- **New** [New]
- **In Progress** [In Progress]
- **Closed Won** [Closed Won]
- **Closed Lost** [Closed Lost]

Editing Time Intervals

The "After Time Elapsed" workflow triggers after a specified period of time has elapsed from when a record save occurs in Sugar. For more information on "After Time Elapsed" workflows, please refer to the [Workflow Management](#) documentation. When creating the conditions for the workflow, you have the option to specify the time interval (e.g. 0 hours, 4 hours, 1 day, 1 week, etc.) used by the system to execute the workflow. The available time interval values can easily be modified via the Dropdown Editor.

The Dropdown Editor contains the "tselect_time_dom" list, which allows administrators to configure the time intervals used for time elapsed workflows. To add new time intervals to the dropdown list, simply enter the "Item Name" and "Display Label", keeping in mind that the item name must display the number of seconds corresponding to the new time interval. The display label value should have the time as it relates to minutes, hours, days, etc. For example, if you are

adding 2 hours to the time interval list, the item name value will be "7200" and the display label will show "2 hours".

Name: tselect_type_dom
Language: English (US)

List Items:
Item Name[Display Label]

•	0 [0 hours]
•	7200 [2 hours]
•	14440 [4 hours]

Editing Role-Based Availability

You can restrict which options are available for a user to select when he or she is editing records based on the user's role. When editing a particular dropdown list, the Roles dropdown appearing on the top right contains all existing roles in the Sugar application. The Default role-list allows admins to add, remove, or reorder options within a dropdown list. By default, none of the other Sugar roles have customized lists, so changes made to the Default role-list will automatically be copied to the other role-lists upon save. This means that as long as no role-list are customized here, all users will continue to see the dropdown options and order matching the Default role-list.

Note: It is recommended to assign each user to a maximum of one role. Users belonging to multiple roles which each have customized role-views may experience unexpected behavior when using record views. For more information about roles, please refer to the [Role Management](#) documentation.

If you wish to restrict certain roles to use a modified list of options when editing records, select the desired role from the Roles dropdown to make changes specific to that role (e.g. Marketing Administrator).

Roles dropdown menu showing:

- Ro ✓ Default
- Customer Support Administrator
- Marketing Administrator (selected)
- Sales Administrator

Buttons: Sort Ascending, Sort Descending

When viewing a Sugar role's role-list (e.g. Marketing Administrator), you have the option to disable, enable, or reorder the existing options. Options cannot be added or deleted via any role-list except "Default". Drag and drop an option in order to change its position in the role-list's options list. To disable an option, deselect the

checkbox in the option's row. Doing so will prevent the option from appearing in the dropdown when a user belonging to this role is editing or creating a record. Once an option is disabled, it will appear greyed out with a strike-through. When the desired changes have been made, click "Save & Deploy".

Note: Each role's role-list must have at least one enabled option.

Analyst [Analyst]	<input checked="" type="checkbox"/>
Competitor [Competitor]	<input checked="" type="checkbox"/>
Customer [Customer]	<input type="checkbox"/>
Custom Type [Custom Type]	<input checked="" type="checkbox"/>

Once you have saved and deployed a modification to a role-list, it is considered customized and will display an asterisk (*) next to the role's name in the Roles dropdown. Reordering options on the Default role-list will no longer have any effect on customized role-lists. However, adding an option, deleting an option, or changing an option's display label on the Default role-list will add, remove, or alter the option for all role-lists including customized role-lists.

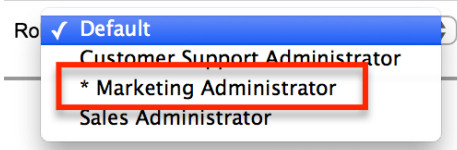

Note: Users will be able to view all dropdown values regardless of role restrictions when viewing records. This means if a record has a dropdown value set to which a user has a role-based restriction, he or she will still be able to view the value.

Note: Role-based customizations to dropdown lists are included when exporting customizations from Studio. For more information, please refer to the [Studio](#) and [Module Loader](#) documentation.

Last Modified: 2020-08-04 14:18:05

Studio

Overview

Studio enables administrators to modify Sugar's fields, page layouts, and more to fit your organization's needs and terminology. Only users with administrator or developer access can make changes via Admin > Studio. This documentation will cover how to use Studio as well as the various actions and options available from within Studio.

Navigation

Studio's navigation is different than other modules within Sugar. Studio is divided into three main sections: the [main panel](#), the [Modules panel](#), and a [footer](#).

Main Panel

The main panel in Studio is where you can access the modules, add fields, configure layouts, and perform other in-app customizations. It displays to the right of the Modules panel and houses the various components (e.g. fields, layouts, subpanels, etc.) of the module. As you select the different components, they will load in new tabs on the main panel.

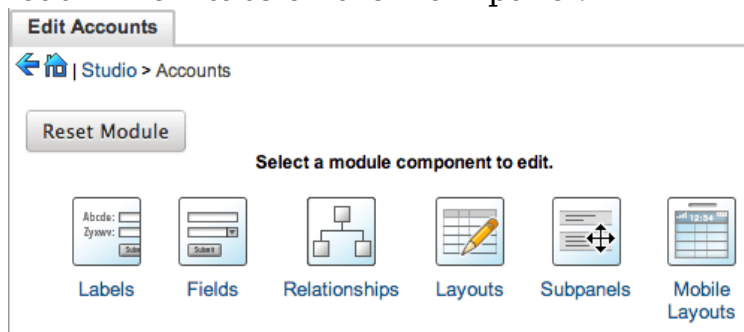

For example, if you select "Fields" on the main panel, the list of available fields along with the options to configure will appear under the Edit Fields tab. Additional tabs that appear as you configure the module can be closed by clicking the "X" within the tab.

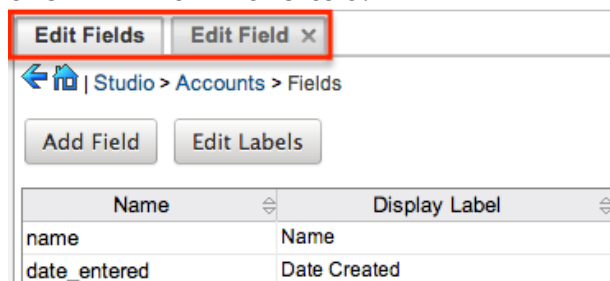

The main panel also includes a breadcrumb bar showing where in Studio you currently are. You can navigate to a specific section by clicking the link within the breadcrumb bar.

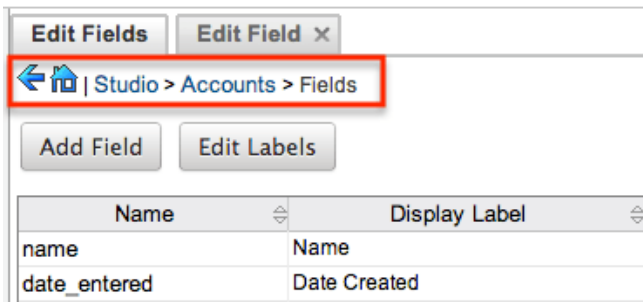

To go back to the previous page that you were viewing, click the Left arrow on the breadcrumb bar. Clicking the Home icon to the right of the arrow will navigate you back to the Developer Tools home page.

Modules Panel

The Modules panel is located to the left of the screen and displays a list of existing stock and custom modules that are editable through Studio. Please note that all modules (e.g. Campaigns, etc.) using the Legacy user interface will display an asterisk (*) to the right of the module's name in Studio. The associated fields, labels, layouts, subpanels, etc. are grouped within each module. Click the plus sign (+) preceding the module name to expand the module tree and display the associated items (e.g. fields, layouts, etc.). Simply select an item in the Modules panel to load the view in the main panel to the right.

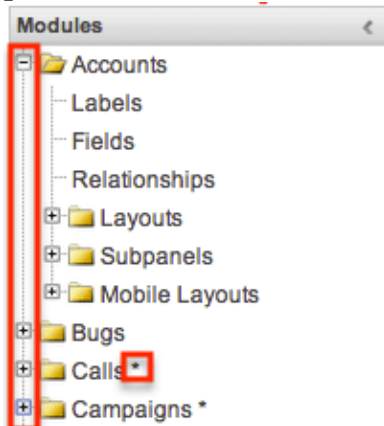

Please note that if you do not see the Modules panel, it may be collapsed. Locate the gray bar to the left of the main panel and click the Right arrow to expand the Modules panel.

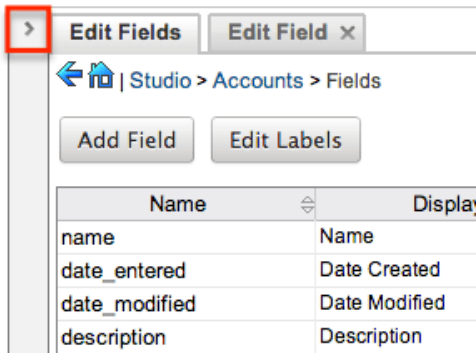

Footer

The footer is located at the bottom of Studio pages and displays buttons which enable you to navigate to the different areas (e.g. Dropdown Editor) of Developer Tools.

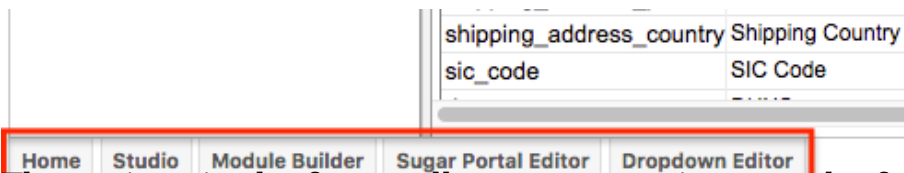

The options in the footer allow you to navigate to the following locations:

Menu Item	Description
Home	Navigates to the home page of the Developer Tools
Studio	Navigates to the home page of Studio
Module Builder	Opens Module Builder to create or edit modules
Sugar Portal Editor	Opens the Sugar Portal Editor to configure the Portal
Dropdown Editor	Opens the Dropdown Editor to modify dropdown options

Editing Labels

Labels are used throughout Sugar to designate field headers, subpanel titles, error messages, and more. To modify the labels for a module, select "Labels" from the Modules panel under the desired module (e.g. Accounts). Please note that HTML tags are not supported in labels.

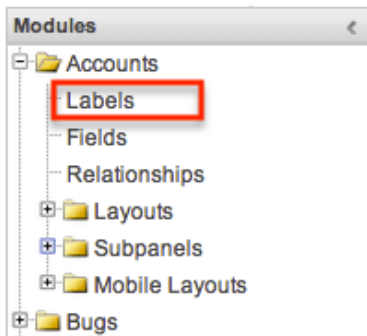

The Edit Labels tab will open in the main panel displaying all the labels associated with the module. Please note that you can change the language for the labels by selecting from the Language dropdown list.

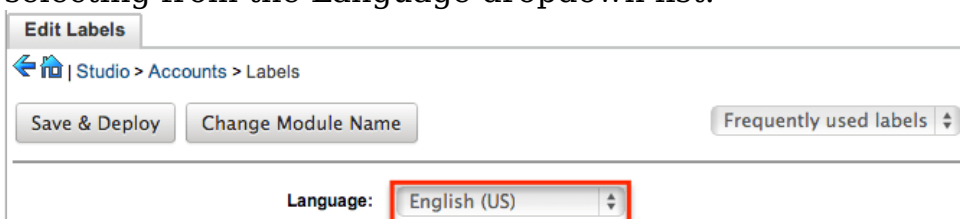

If the label you wish to change cannot be found, change the filter dropdown option from "Frequently used labels" to "All Labels".



Modify the labels accordingly per the selected language and click "Save and Deploy" when complete. This will save your changes and instantly deploy them to your Sugar instance.

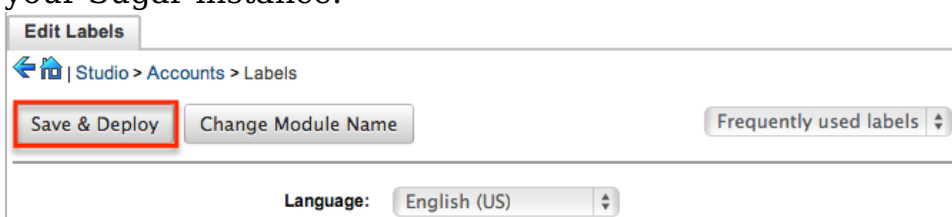

To change the name of the module, click "Change Module Name" to the right of the Save & Deploy button.

This will direct you to the Rename Modules page where you can change the labels for the module accordingly. For more information on how to rename modules, please refer to the [Rename Modules](#) section of the Developer Tools documentation.

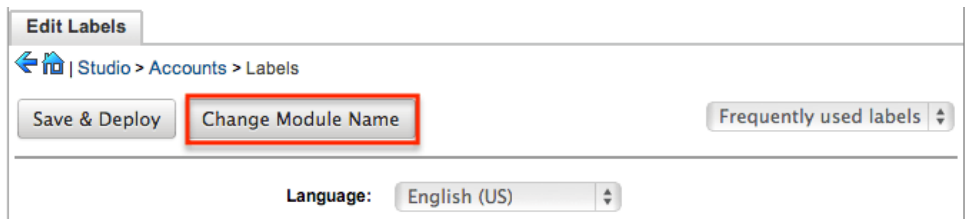

Fields

The Fields section in Studio allows administrators to create new fields for stock and custom modules as well as update existing fields. To access the Fields section in Studio, select "Fields" from the Modules panel under the desired module (e.g. Cases) and the Edit Fields tab will open in the main panel.

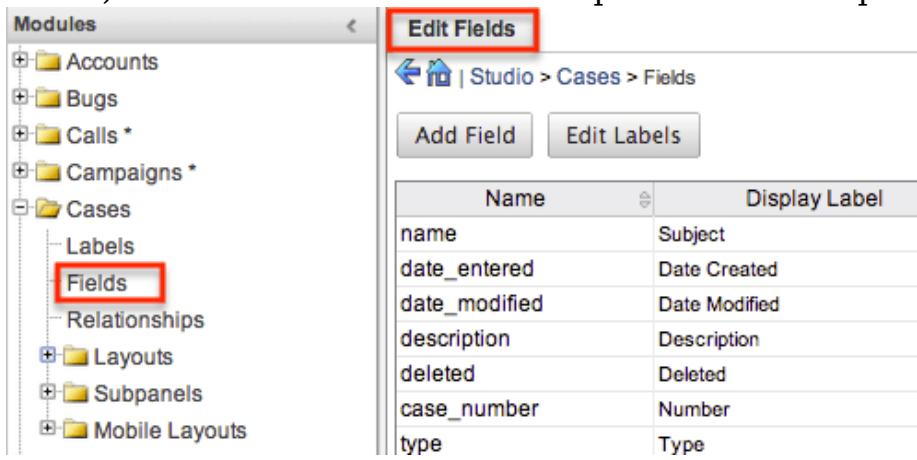

Field Types

Studio comes out-of-the-box with many different types of fields which can be created in Sugar. Please note that the options and properties available when configuring the field varies for each data type.

The following data types are available when creating fields in Studio:

Data Type	Description
Address	Creates fields for street, city, postal code, state, and country. Note: Custom address fields cannot be grouped together like stock address fields (e.g. billing address).
Checkbox	Creates a checkbox for data fields with a Yes/No action.

Currency	Creates a field to enter a currency value. The system automatically creates a dropdown of the currency type if the field does not already exist in that module.
Date	Creates a field to enter a date. Includes a button for a calendar popup.
DateTime	Creates a field to enter the date and time. Includes a Calendar icon button to choose a date via the popup calendar, as well as a dropdown list to select the time.
Decimal	Creates a field to hold a number rounded to a specified decimal precision. Sugar stores the exact representation of the number in the database (e.g. For a precision of 2: 1.236 is stored as 1.24).
Dropdown	Creates a field where you can associate a dropdown list of values.
Encrypt	Creates a field for sensitive information, such as social security numbers, whose value is to be encrypted in the Sugar database. The value is encrypted using the Blowfish algorithm prior to being captured in the database. It is decrypted prior to display in the user interface to users. The first time an encrypted field is enabled, a unique key is automatically generated and stored on the filesystem in the file <code>./custom/blowfish/encrypt_field.php</code> . This generated key is used for all subsequent field level encryption and decryption operations.
Flex Relate	Creates a dropdown list from which you can relate a single record from a variety of modules. Note: Only one Flex Relate-type field is allowed per module. Out of the box, the Flex Relate option is not available for the Accounts, Calls, Contracts, Meetings, Notes, and Tasks modules.

Float	Creates a field to hold a number rounded to a specified decimal precision. Sugar stores the value differently based on the database platform Sugar is running on.
HTML	Creates static HTML-formatted text to display in record views.
IFrame	Creates a field to store or generate a URL to display an iFrame in record views.
Image	Creates an image field to upload an image to display on a record.
Integer	Creates a field to specify positive or negative numbers with no decimal places.
MultiSelect	Creates a dropdown list of values where multiple values can be selected at once.
Phone	Creates a field to enter a phone number.
Radio	Creates a radio button for a user to select one value from a dropdown list.
Relate	<p>Creates a field to associate a record with another module's record as a one-way relationship. You can add multiple Relate fields to a module.</p> <p>Note: Relate fields and custom relationships are independent of each other. Changes made to either one are not reflected in the other. Relate fields can be added to a report, but any data on the related record cannot be accessed in the report. To access related record data in a report you will need to create a custom relationship.</p>
TextArea	Creates an open text area field for multiple lines of text.
TextField	Creates a field for a single line of text.
URL	Creates a field to store or generate a URL and display as a link.

Note: Name-type and ID-type fields cannot be created via Studio. Each stock

module and module created via Module Builder will have a Name-type and ID-type field. The Name-type field is automatically displayed in the header of each record view (for Sidecar modules) while the ID field is not available in Studio but is a part of the unique URL for each record.

Field Options

Fields provide ways to store different data types in Sugar. While many fields come with Sugar by default, there can be instances where your organization needs to create custom fields to store additional data.

Each field, depending on the data type, will have different properties and options available when configuring the field via Studio. Please note that some properties can exist across all data types and some are unique to only a few types.

The following properties and options are available for fields in Studio:

- **Audit** : Select this checkbox to audit the field for changes made in Sugar.
 - Users can view the changes made to audited fields via the View Change Log option in the module's record view (for Sidecar modules) or detail view (for Legacy modules).
 - Fields marked as "Audit" will generate update posts in the activity stream for Sidecar modules (e.g. Accounts, Contacts, etc.) whenever the field gets updated. For more information on activity streams, please refer to the [Activity Streams](#) documentation.
- **Boost value** : Enter a boost value for the field to enhance the relevancy of the field for full-text search.
 - The default boost value is 1.0 which indicates a neutral boost. To apply a positive boost, set the boost value higher than 1. To apply a negative boost, use values lower than 1. For example, a value of 1.35 will positively boost a field by 135%. But using a value of 0.60 will apply a negative boost.
 - **Note:** It is not necessary to perform a full system index when boost values are changed for fields.
- **Border** : For Image data type fields, select this checkbox to add a border around the image for this field.
- **Calculated Value** : Select this checkbox to designate this field as a calculated field.
 - This opens up the Formula option and disables the Default Value and Importable options. For more information regarding entering a formula for a calculated value, please refer to the Formula option listed in this section.

Calculated Value: 

Formula:

- The result of the formula will be entered into the field for any new or modified records. When selecting this option, the field value cannot be modified by users.
- **Note:** The Calculated Value option is only available for the following data type fields:

Checkbox	Currency
Date	Datetime
Decimal	Encrypt
Float	Integer
Phone	TextArea
TextField	

- **Columns** : For TextArea data type fields, enter the number of columns to specify the width of a TextArea data type field.
- **Comment Text** : Enter a comment or description about the field. The comment text is only viewable via Studio.
 - **Note:** The Comment Text option is available for all data type fields except Flex Relate.
- **Default Value** : Specify or select a default value for this field when a record is created. Default values for the record are populated by default but can be modified by users.
 - **Note:** The Default Value option is available for all data type fields except HTML, Image, Flex Relate, and Relate.
- **Dependent** : Select this option to designate this field as being dependent on a formula or a parent dropdown.
 - For dropdown data type fields you can select "Parent Dropdown" or "Formula" for the dependency.

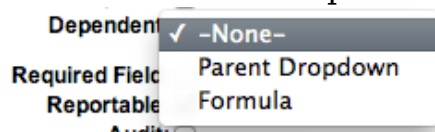

- Selecting "Parent Dropdown" will open the Parent Dropdown option as shown below. Selecting "Formula" will open the "Visible If" option to create a dependency formula. For other field data types (e.g. Date), select the Dependent checkbox to open the Visible If option. For more information regarding entering a formula to make a dependent field visible, please refer to the Visible If option listed in this section.



- **Note:** The Dependent option is available for all data type fields except Address.
- **Disable Format** : For Integer data type fields, select this checkbox to

disable number formatting such as the thousands separator.

- **Display Label** : Enter a value to display as the field label and header in layouts. Normally defaults to the Field name entered when creating field.
 - This value is also modifiable via the [Labels](#) section of Studio.
 - **Note:** The Display Label option is available for all data type fields except Flex Relate. Flex Relate uses the Label Value option.

- **Drop Down List** : Select a list of values to associate to the field.

Drop Down List: 

- Only values in the chosen list will be available for selection in the field. Click "Edit" to change the values for the currently selected list, or click "Add" to create a new list.
 - **Note:** The Dropdown List option is only available for the dropdown, multiselect, and radio data type fields. For more information on editing dropdown values via the Dropdown Editor, please refer to the [Editing Dropdown Lists](#) section of the Developer Tools documentation.
- **Duplicate Merge** : Select one of the following options to determine the field's functionality when records are being merged:
 - **Disabled** : Selected by default. The field will not appear on the Merge Duplicates screen.
 - **Enabled** : The field will appear on the Merge Duplicates screen.
 - **In Filter** : (Legacy/BWC modules only) The field will appear in the Merge Duplicates feature, and will also be available in the Find Duplicates feature.
 - **Default Selected Filter** : (Legacy/BWC modules only) The field will be used for a filter condition by default in the Find Duplicates page, and will also appear in the Merge Duplicates feature.
 - **Filter Only**: (Legacy/BWC modules only) The field will not appear in the Merge Duplicates feature but will be available in the Find Duplicates feature.
 - **Note:** The Duplicate Merge option is available for all data type fields except Image.
 - **Field Name** : Enter the name of the field being created. Once a field has been created the field name cannot be changed.
 - Field names can contain only alphanumeric characters as well as the underscore character.
 - Custom fields added via Studio are automatically appended with "_c" to ensure the field does not conflict with a current or future stock field.
 - **Full Text Searchable** : Specify whether or not the field should affect Global Search results.
 - **Disabled** : Select "Disabled" if you do not want this field to be captured when the database is indexed for searches. Search indices collect the values of searchable fields for evaluation by the Global

Search.

- **Searchable** : Select "Searchable" to include this field's value in search indexes.
 - Selecting "Searchable" will reveal the Boost value field, which allows you to set a relevance weight for searches. When a user's search query matches the value of a field with a higher boost level, the record will appear higher in the search results. For more information regarding boost values in Full-Text Search, please refer to the [Search](#) documentation in the Application guide.
 - The Full Text Searchable option is only available for the following data type fields:

Phone	TextArea
TextField	URL

- **Note**: For a list of searchable fields for each module for global search, please refer to the [Search](#) documentation in the Application guide.
- **Formula** : Contains the current formula to return a calculated value.
 - Click "Edit Formula" to launch the formula builder and change the formula. For more information on how to build a formula using the formula builder, please refer to the [Using Sugar Logic](#) section of this documentation.

Calculated Value: ⓘ

Formula:

- **Note**: The Formula option is only available when the Calculated Value option is selected when editing or creating a field.
- **Generate URL** : For IFrame and URL data type fields, select this checkbox to allow variables from the current module to be placed into the Default Value option for creating dynamic URLs.

Generate URL:

Default Value:

- This is useful for providing links or iFrames to internal systems such as an ERP or to external systems such as Google Maps.
 - Select the desired field to add from the dropdown and click "Insert Field" to add the field to the Default Value. When selecting this option, the field value cannot be modified by users.
- **Height** : For Image data type fields, enter the number of pixels to

vertically scale the image for this field. Enter only the Width or Height options to retain the aspect ratio of the image.

- **Help Text** : Enter basic instructions for populating this field. The text entered here will display below the field when creating or editing a record for modules using the Sidecar user interface. For modules using the Legacy user interface, the help text will appear when users hover their mouse within the field in the Edit View layout.
- **HTML** : For HTML data type fields, enter static rich text with formatting or HTML code to display on a record. For more information on how to use the text editor please refer to the [TinyMCE](#) section of the User Interface documentation in the Application guide.

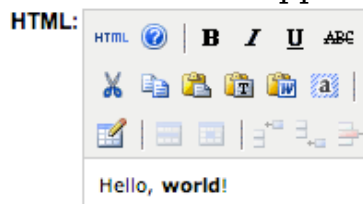

- **IFrame Height** : For IFrame data type fields, enter the number of pixels for the height of the IFrame field. The width of the IFrame field is always the width of the field container.
- **Importable** : Select one of the following options to determine the field's functionality when records are being imported:
 - **Yes** : The field can be included in an import operation.
 - **No** : The field cannot be included in an import.
 - **Required** : A value for the field must be provided in any import.
- **Label Value** : For Flex Relate data type fields, enter a value to display as the field label and header in layouts. This value is also modifiable in the Modules panel under [Labels](#). Defaults to "Flex Relate".
- **Mass Update** : Select this checkbox to add this field as an option to mass update.
 - **Note:** The Mass Update option is only available for the following data type fields:

Date	Datetime
Dropdown	MultiSelect
Radio	

- **Max Size** : Enter the maximum number of characters (or, for DB2 databases, the maximum number of bytes) allowed for this field. Defaults to 255.
 - **Note:** The Max Size option is only available for the following data type fields:

Address	Decimal
Float	IFrame
Integer	Phone

URL

TextField

- **Max Value** : For Integer data type fields, enter the highest value allowable for this field. If a user enters a higher value in the field than the specified value, a notification will appear upon save informing them of the set maximum value.
- **Min Value** : For Integer data type fields, Enter the lowest value allowable for this field. If a user enters a value in the field that is lower than the specified value, a notification will appear upon save informing them of the set minimum value.
- **Module** : For Relate data type fields, select a module from the dropdown to relate to the current module.
 - A module can relate back to itself, a good example of this would be a relate field on Contacts to relate back to Contacts for a referred by field. This will allow users to select which contact record referred a different contact. The chosen module cannot be modified once the field is created.

Module:

- **Open Link In** : For URL data type fields, select one of the following options to determine how a URL will open:
 - **New Window** : Opens the URL in a new Tab or Window depending on your browser and settings.
 - **Same Window** : Opens the URL in the same window as the record you are currently browsing.
- **Parent Dropdown** : When the Dependent option has "Parent Dropdown" selected, choose an option from the dropdown to specify the parent that controls the visibility of this dropdown field.
 - The Parent Dropdown option is populated with the other dropdown data type fields in the current module.

Dependent:

Parent Dropdown:

- Click "Edit Visibility" to specify which options are available from the current dropdown for each value of the parent dropdown. In the Visibility Editor window, drag values from the current dropdown list to the value sections of the parent dropdown.

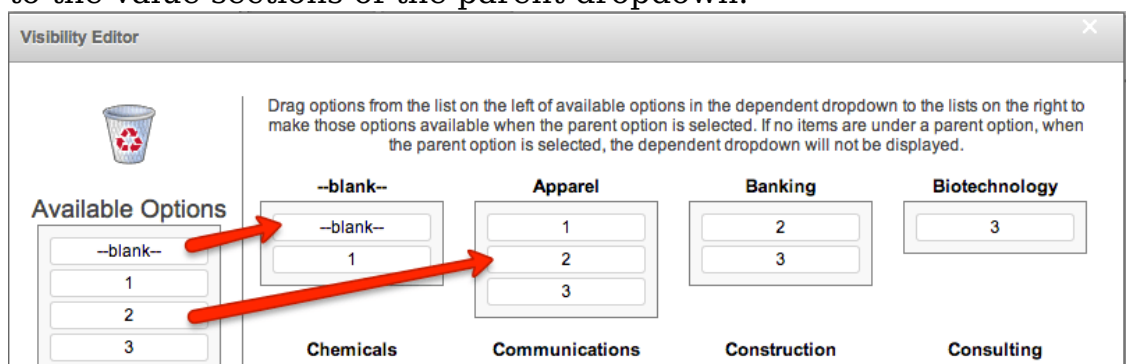

- This will determine which options in the dropdown list are available when the parent dropdown is set to the specified value. In this example, if the parent dropdown is set to "Apparel", then the current dropdown will have options 1, 2, and 3 where if the parent dropdown is set to "Banking", then the current dropdown will only have options 2 and 3 available. If there are no available options for a parent dropdown value, then the dependent dropdown will not display. To remove an item from the list, simply click and drag the value to the Trash bin on the left. Once the values are set, click "Save" to preserve your changes.

- **Precision** : For Decimal and Float data type fields, enter a number to specify the number of digits to the right of the decimal point the value should be stored as in Sugar.
- **Reportable** : Select this checkbox to allow the field to be used in reports.
 - **Note:** The Reportable option is available for all data type fields except Encrypt, Flex Relate, HTML, IFrame, and Image.
- **Required Field** : Select this checkbox to mark the field as required in Sugar. The user will be required to enter a value for the field when saving the record.
 - **Note:** The Required option is available for all data type fields except Checkbox and HTML.
- **Rows** : For TextArea data type fields, enter the number of rows to specify the height of a TextArea data type field.
- **System Label** : Enter the system value for storing the label of the field. This is defaulted to the name of the field preceded with "LBL_ ". Any lowercase characters entered will be converted to an uppercase upon saving. Once the field has been created, the system label cannot be changed.
 - It is recommended that administrators avoid naming fields with the same system label in order to prevent the same label and header values from existing in the system.
- **Visible If** : Contains the current formula to determine if a field is visible on the layout or not. Click "Edit Formula" to launch the formula builder to change the formula.

Dependent:

Visible If:

- The formula must result in a Boolean (true/false) response. For more information on how to build a formula using the formula builder, please refer to the [Using Sugar Logic](#) section of this

documentation.

- **Note:** The "Visible If" option is only available when the Dependent option is checked or "Formula" is selected from the dropdown.
- **Width** : Enter the number of pixels to horizontally scale the image for this field. Enter only the Width or Height options to retain the aspect ratio of the image.
 - **Note:** The Width option is only available for Image data type fields.

Creating Fields

Use the following steps to create a new field via Studio:

1. Expand out the tree under the desired module (e.g. Cases) in the Modules panel and select "Fields".

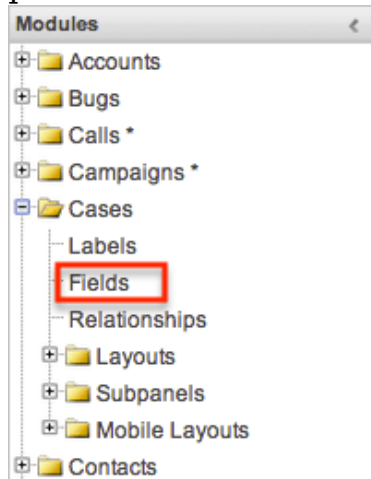

2. In the main panel, click "Add Field".

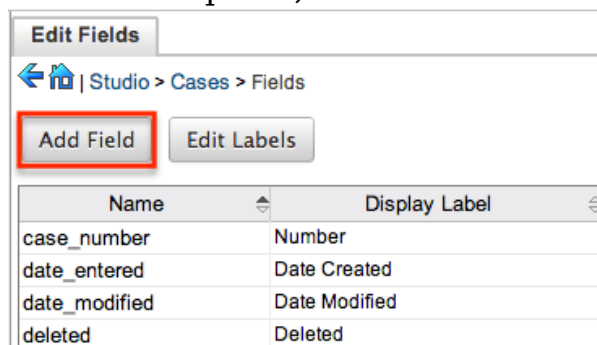

3. Enter appropriate values for the [Field Options](#).
Note: Field Name is required.
4. Once the necessary information is entered, click "Save".

Please note that once a field is created, it must be placed on the record view (for Sidecar modules) or edit view (for Legacy modules) layout before users can enter data into that field. For more information on editing layouts, please refer to the [Editing Layouts](#) section of this documentation.

Editing Fields

Use the following steps to edit an existing field via Studio:

1. Expand out the tree under the desired module (e.g. Cases) in the Modules panel and select "Fields".

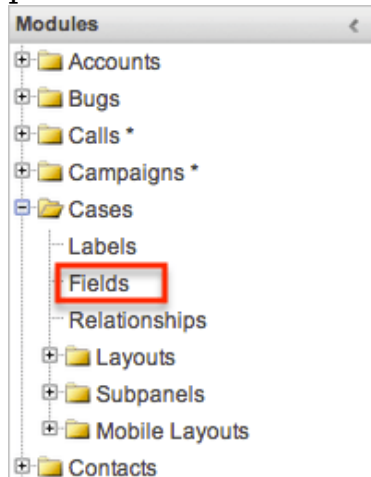

2. In the main panel, select a field to edit. Sorting the fields by the column header will help in locating the field faster.
 - **Note:** Fields created via Studio will display an asterisk next to their names.

Edit Fields

← Studio > Cases > Fields

Add Field Edit Labels

Name	Display Label	Type
case_number	Number	Integer
date_entered	Date Created	Datetime
date_modified	Date Modified	Datetime
deleted	Deleted	Checkbox
description	Description	TextArea
name	Subject	Name
portal_viewable	Show in Portal	Checkbox
priority	Priority	DropDown
resolution	Resolution	TextArea
status	Status	DropDown
* support_level_c	Support Level	DropDown
system_id	System ID	Integer
type	Type	DropDown
work_log	Work Log	TextArea

* field created in Studio

3. Enter appropriate values for the [Field Options](#).
4. Once the necessary information is entered, click "Save".

Edit Fields Edit Field ×

Save Cancel Clone

Data Type: TextArea
 Field Name: description
 Display Label:
 System Label:
 Help Text:
 Comment Text:
 Rows:
 Columns:

Deleting Fields

Use the following steps to delete an existing field via Studio:

1. Expand out the tree under the desired module (e.g. Cases) in the Modules panel and select "Fields".

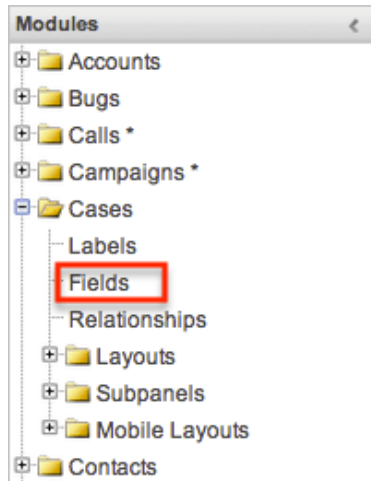

2. In the main panel, select a field to delete. Sorting the fields by the column header will help in locating the field faster.
 - Fields created via Studio will display an asterisk (*) next to their names.
 - **Note:** Stock fields cannot be deleted.

Edit Fields

← | Studio > Cases > Fields

Add Field Edit Labels

Name	Display Label	Type
case_number	Number	Integer
date_entered	Date Created	Datetime
date_modified	Date Modified	Datetime
deleted	Deleted	Checkbox
description	Description	TextArea
name	Subject	Name
portal_viewable	Show in Portal	Checkbox
priority	Priority	DropDown
resolution	Resolution	TextArea
status	Status	DropDown
* support_level_c	Support Level	DropDown
system_id	System ID	Integer
type	Type	DropDown
work_log	Work Log	TextArea

* field created in Studio

3. Click "Delete" to remove the field.

The screenshot shows the 'Edit Fields' dialog box with the following details:

- Data Type:** DropDown
- Field Name:** support_level_c
- Display Label:** Support Level
- System Label:** LBL_SUPPORT_LEVEL
- Help Text:** The current support le
- Comment Text:** (empty)
- Drop Down List:** support_level_list

Buttons at the top: Save, Cancel, Delete (highlighted), Clone. Buttons at the bottom: Edit, Add.

4. A pop-up message will display asking for confirmation. Click "Ok" to proceed.
 - When deleting fields, both the field and all the data related to the field in the database will be permanently removed. Before deleting a field, confirm that the field is no longer used or displayed in the following places:
 - Report filters or display columns
 - Workflows that filter by or display the field
 - Dashlets that filter by or display the field
 - Sugar Logic formulas for other fields
 - Email templates
 - Saved searches (legacy modules)
5. The field will automatically be removed from any module layouts when deleted.

Cloning Fields

Use the following steps to clone an existing field via Studio:

1. Expand out the tree under the desired module (e.g. Cases) in the Modules panel and select "Fields".

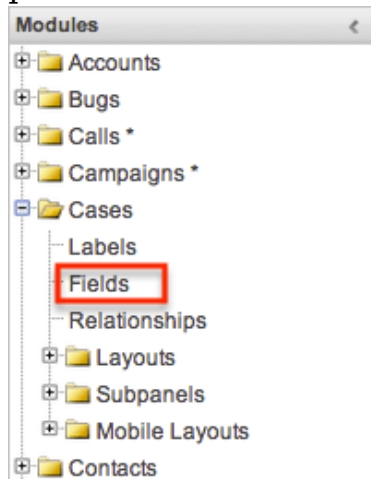

2. In the main panel, select a field to delete. Sorting the fields by the column header will help in locating the field faster.
 - **Note:** Fields created via Studio will display an asterisk (*) next to their names.

Name	Display Label	Type
case_number	Number	Integer
date_entered	Date Created	Datetime
date_modified	Date Modified	Datetime
deleted	Deleted	Checkbox
description	Description	TextArea
name	Subject	Name
portal_viewable	Show in Portal	Checkbox
priority	Priority	DropDown
resolution	Resolution	TextArea
status	Status	DropDown
* support_level_c	Support Level	DropDown
system_id	System ID	Integer
type	Type	DropDown
work_log	Work Log	TextArea

* field created in Studio

3. Select "Clone" to duplicate the field.
 - **Note:** Some non-standard stock fields (e.g. Name) do not have the ability to clone.

Edit Fields | Edit Field x
 Save Cancel Delete **Clone**

Data Type: DropDown
Field Name: support_level_c
Display Label: Support Level
System Label: LBL_SUPPORT_LEVEL
Help Text: The current support le
Comment Text:
Drop Down List: support_level_list

Edit Add

4. Enter appropriate values for the [Field Options](#).
5. Once the necessary information is entered, click "Save".

Edit Fields Edit Field x
 Save Cancel

Data Type: DropDown
 Field Name: secondary_support
 Display Label: Secondary Support
 System Label: LBL_SECONDARY_SUPP
 Help Text: The current support le
 Comment Text:
 Drop Down List: support_level_list
 Edit Add
 Default Value: Standard
 Mass Update:
 Dependent: -None-
 Required Field:

Relationships

Relationships define the links between different modules in Sugar and allow records between those modules to be related. Related records display in fields or subpanels on a module's record view (for Sidecar modules) or detail view (for Legacy modules) depending on the relationship type. When you create a new relationship between two modules, the system automatically creates the necessary subpanels, related fields, and metadata relationships. Relationships provide the added benefit in reports to allow access to a related records fields in addition to the base module's fields.

The relationships section in Studio allows administrators to create new relationships between custom and stock modules as well as change some properties on existing relationships. To access the Relationships section in Studio, select "Relationships" from the Modules panel and the module's relationship tab will open in the main panel.



Relationship Types

Sugar contains a few different types of relationships you can create between modules. The relationship type will determine which fields or tables will be created in the database as well as what the interface will look like to the user when managing relationships for the affected records.

When you create a relationship between modules, the module you initiate the relationship from is considered the primary module and the module that you relate it to is the related module.

The following sections explain the relationship types available in Studio.

One-to-One Relationships

When records in the primary module and the related module are uniquely related to each other, you have a one-to-one relationship. In other words, each primary record will relate to only one related record and vice-versa.

As an example, in a one-to-one relationship between Accounts and Contacts, an account can be associated with only one contact and a contact can be associated with only one account. The relationship will show as a field in each module's record view. For this two-way relationship, changing the related record from one module's record will also change the value in the other module's record.

- From the primary Accounts module:

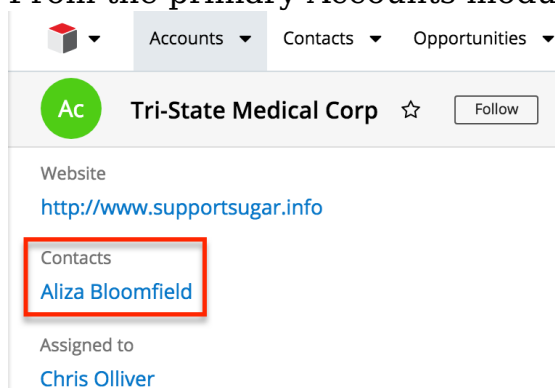

- From the related Contacts module:

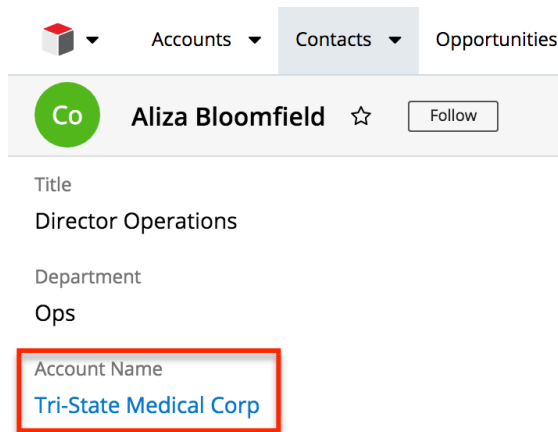

Note: You can alternatively create a one-way relationship between modules using relate fields. For more information regarding relate fields, please refer to the [Field Types](#) section of this documentation.

One-to-Many and Many-to-One Relationships

In one-to-many relationships, one primary record may relate to many records in the related module, but the related module records will only be able to relate to one primary record. This is often referred to as a parent-child(ren) relationship.

Note: Only modules with subpanels available can be on the "Many" side of a relationship. For example, the Product Catalog module lacks a subpanel; therefore, Product Catalog can only be selected on the "One" side of a relationship.

As an example, in a one-to-many relationship between Accounts and Contacts, an account can be associated with many contacts, but each contact can be associated with only one account. The record view of the primary module will display a subpanel for the related module, and the record view of the related module will display a field containing a link to the related record.

A one-to-many relationship is the same as a many-to-one relationship except the primary and related modules are reversed.

- From the primary Accounts module:

Accounts Contacts Opportunities Leads Calendar Reports

Ac Tri-State Medical Corp ☆ Follow

Website: <http://www.supportsugar.info> Industry: Consulting

Member of: Type: Customer

Assigned to: Chris Olliver Office Phone: (171) 906-5479

Show more...

Related All Filter All Records Search...

Co CONTACTS (3)

Name	City	State	Er
☆ Aliza Bloomfield	San Francisco	NY	be

- From the related Contacts module:

Accounts Contacts Opportunities

Co Aliza Bloomfield ☆ Follow

Title: Director Operations

Department: Ops

Account Name: [Tri-State Medical Corp](#)

You can also create a one-to-many relationship between a module and itself. For example, Sugar relates Accounts to Accounts in order to allow "Member Organization" sub-accounts within the primary "Member of" parent account.

Note: Adding a custom one-to-many relationship to "Activities" will add custom relationships to calls, meetings, notes, tasks, and emails. This will also automatically add these subpanels to the record view.

Many-to-Many Relationships

In many-to-many relationships, many primary records may be related to many related records, often overlapping. For example, the contact Joe Smith may relate to many different Sugar campaign records, and each of those campaign records may relate to many contacts in addition to Joe Smith.

For a many-to-many relationship between Accounts and Contacts, an account could be associated with many contacts, and a contact, in turn, could be associated with many accounts. Both modules' record views would display a subpanel for the opposite module.

Note: Only modules with subpanels available can be on the "Many" side of a relationship. For example, the Product Catalog module lacks a subpanel; therefore, Product Catalog can only be selected on the "One" side of a relationship.

Creating Relationships

Use the following steps to create a new relationship via Studio:

1. Expand the tree under the desired module (e.g. Cases) in the Modules panel and select "Relationships".

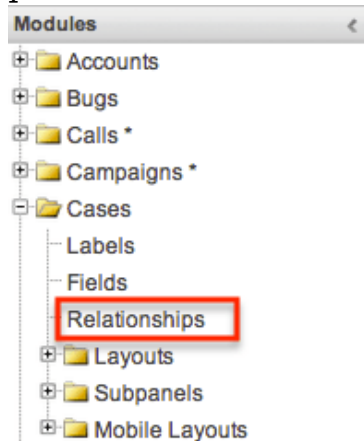

2. In the main panel, click "Add Relationship".

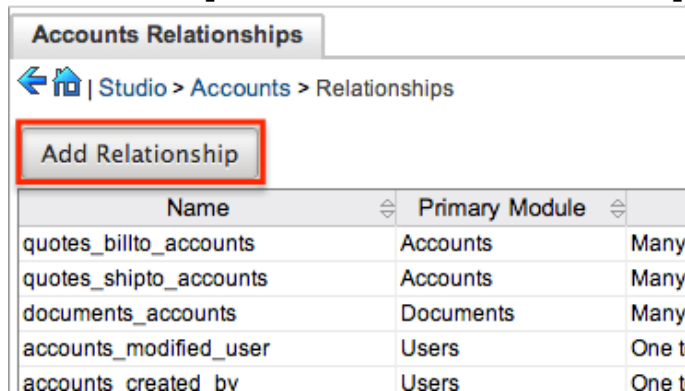

3. Enter appropriate values for the following options:

Type : Select the type of relationship to create from the options in the [Relationship Types](#) section.

Module : The Primary module is set as the module to which you are adding the relationship. Select the related module from the dropdown list to the right. The Primary and Related module can be the same in order to create a parent-child relationship.

Label : Enter a label to reference the Primary module or Related module's subpanels for this relationship.

◦ **Note:** This option is only available for the "Many" side of a relationship. Select a subpanel option to display the Primary or Related module's records in. This will determine the fields displayed in the subpanel.

- **Note:** This option is only available for the "Many" side of a relationship.
4. Once the necessary information is entered, click "Save & Deploy".

Primary Module		Type	Related Module	
Module:	Cases	Many to Many	Module:	Products
Label:	Product Cases		Label:	Products Affected
Subpanel from Cases:	default		Subpanel from Products:	ForProducts

5. The required fields and subpanels are instantly created and deployed to the appropriate modules.

Editing Relationships

Use the following steps to edit a relationship via Studio:

1. Expand out the tree under the desired module (e.g. Cases) in the Modules panel and select "Relationships".

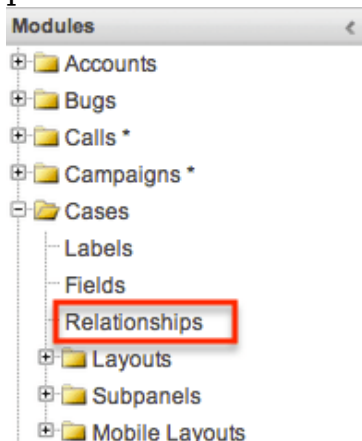

2. In the main panel, select a relationship to edit.
- Sorting the column header will help in locating the relationship faster.
 - **Note:** Relationships created via Studio will display an asterisk next to their names.

Cases Relationships

← Studio > Cases > Relationships

Add Relationship

Name	Primary Module	Type	Related Module
case_kbdocuments	Cases	One to Many	Knowledge Base
cases_bugs	Cases	Many to Many	Bug Tracker
contacts_cases	Contacts	Many to Many	Cases
projects_cases	Projects	Many to Many	Cases
documents_cases	Documents	Many to Many	Cases
cases_products_1*	Cases	Many to Many	Products
cases_modified_user	Users	One to Many	Cases
cases_created_by	Users	One to Many	Cases
cases_assigned_user	Users	One to Many	Cases
case_calls	Cases	One to Many	Calls
case_tasks	Cases	One to Many	Tasks
case_notes	Cases	One to Many	Notes
case_meetings	Cases	One to Many	Meetings
account_cases	Accounts	One to Many	Cases

* relationship created in Studio

- The only editable field on a relationship is the Label field for naming the Primary or Related modules subpanels.
 - Note:** This option is only available for the "Many" side of a relationship.
- Once the necessary information for the Label field is entered, click "Save".

Cases Relationships Edit Relationship ×

Save Cancel Delete

Language: English (US)

Name: cases_products_1

Primary Module	Type	Related Module
Module: Cases	Many to Many	Module: Products
Label: Product Issues		Label: Products Affected
Subpanel from Cases: default		Subpanel from Products: ForProducts

Deleting Relationships

Use the following steps to delete a relationship via Studio:

- Expand out the tree under the desired module (e.g. Cases) in the Modules panel and select "Relationships".

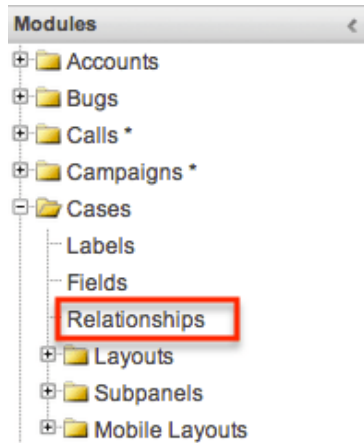

2. In the main panel, select a relationship to delete.
 - Sorting the column header will help in locating the relationship faster.
 - **Note:** Relationships created via Studio will display an asterisk next to their names.

Cases Relationships

← Studio > Cases > Relationships

Add Relationship

Name	Primary Module	Type	Related Module
case_kbdocuments	Cases	One to Many	Knowledge Base
cases_bugs	Cases	Many to Many	Bug Tracker
contacts_cases	Contacts	Many to Many	Cases
projects_cases	Projects	Many to Many	Cases
documents_cases	Documents	Many to Many	Cases
cases_products_1*	Cases	Many to Many	Products
cases_modified_user	Users	One to Many	Cases
cases_created_by	Users	One to Many	Cases
cases_assigned_user	Users	One to Many	Cases
case_calls	Cases	One to Many	Calls
case_tasks	Cases	One to Many	Tasks
case_notes	Cases	One to Many	Notes
case_meetings	Cases	One to Many	Meetings
account_cases	Accounts	One to Many	Cases

* relationship created in Studio

3. Select "Delete" to remove the relationship.

Cases Relationships Edit Relationship ×

Save Cancel **Delete**

Language: English (US)

Name: cases_products_1

Primary Module	Type	Related Module
Module: Cases	Many to Many	Module: Products
Label: Product Issues		Label: Products Affected
Subpanel from Cases: default		Subpanel from Products: ForProducts

4. A pop-up message will display asking for confirmation. Click "Yes" to proceed.

-
- **Note:** If you wish to retain the data and table structure that currently exists for the relationship, select the "Do Not Remove Tables" option. Leaving the "Do Not Remove Tables" unchecked will delete the relationship data and remove the tables for the relationship from the database.
 - Before deleting a relationship please verify and resolve the following issues:
 - Relationship must be removed from any report filters or displays
 - Relationship must be removed from any workflows that filters or displays fields from the relationship
 - Relationship must be removed from any Sugar Logic formulas referencing the relationship

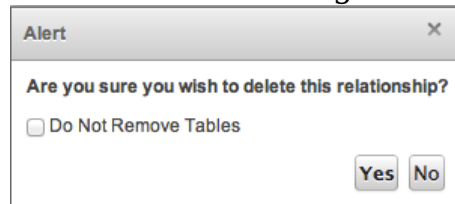

Layouts

The layouts in Studio are used to represent the various views (e.g. record view, list view, edit view, etc.) in Sugar. Users with administrator or developer access have the ability to configure these layouts via Admin > Studio. Please note that the layouts available to configure will vary based on whether the module uses the Sidecar or Legacy user interface. All modules using the Legacy user interface will display an asterisk (*) to the right of the module's name in Studio. The available layouts for the selected module will appear once you open up the Layouts option.

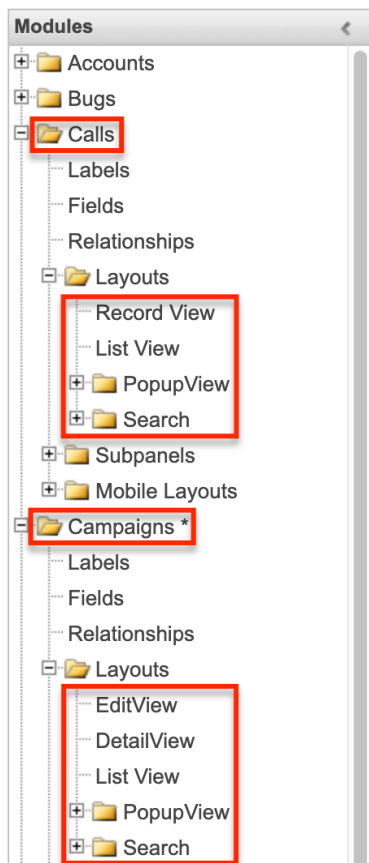

Layout Types

Sugar comes with different types of layouts to represent different sections of Sugar. Please note that not all layouts are available in every module.

The following layout options are available in Sugar:

- **Convert Lead** : The Convert Lead layout can be configured to mark modules as required for lead conversion, add or remove modules from the convert lead layout, etc. Please note that the Convert Lead layout is only available for the Leads module. For more information on modifying the Convert Lead layout, please refer to the [Editing Convert Lead Layout](#) section below.
- **Record View(for Sidecar modules)** : Record view is used to modify, create, or view the current record's details within a specified module. This layout is specific to modules using the Sidecar user interface and controls the layout for viewing, creating, and editing a record, as well as the quick-create layout and the fields displayed when the record is viewed via the preview pane.
- **Record View Dashlet (for Sidecar modules)** : The Record View dashlet displays the record view of a module within a tab of the dashlet. This layout

is used to configure the fields displayed in the tab. Note that this layout configuration is only available for the Accounts, Cases, and Opportunities modules and the dashlet can only be used by Sugar Sell and Sugar Serve users.

- **Edit View (for Legacy modules)** : Edit view layout is used to modify or create records in the specified module.
- **Detail View(for Legacy modules)** : Detail view layout is used to view the current data for a record within the specified module.
- **List View** : List view layout is used to view multiple records within the specified module. The list view is also used for displaying the results from module search (for Sidecar modules), as well as Basic or Advanced search (for Legacy modules).
- **Quick Create (for Legacy modules)** : Quick Create layout is used in Sugar to quickly view and modify records within a specified module without having to navigate away from the current page. For example, logging a call from the Quotes detail view will open up the call's quick create form.
- **Popup List View** : Pop-up list view layout is used to view a list of records in a pop-up window when selecting one or more records to relate to a current record.

Account List

Acct. Name	City	State	Country	User
SugarCRM Inc	Cupertino	California	United States	Administrator

- **Popup Search(for Legacy modules)** : Pop-up search layout allows users to search for records in the pop-up window to relate to a current record and appears above the pop-up list view in the same window. Legacy modules (e.g. Quotes) use this layout for pop-up searching while Sidecar modules (e.g. Accounts) use the Search layout's configuration.

Account Search

Name	<input type="text" value="Sugar"/>	Billing City	<input type="text"/>
Billing State	<input type="text"/>	Billing Country	<input type="text"/>
Any Email	<input type="text"/>	Assigned to	Administrator Will Westin
<input type="button" value="Search"/> <input type="button" value="Clear"/>			

- **Search** : Search layout is used to allow users to search for records from a module's list view via module search (for Sidecar modules) or Basic and

Advanced search (for Legacy modules). This layout is also used by Sidecar modules on the pop-up search and select. In addition, changes made to the Search layout for Sidecar modules affects the list of available fields to filter for the module's list view dashlet (e.g. My Contacts) since it is controlled by the same layout as well.

Note: Encrypt fields cannot be added to Search layouts.

Layout Options

Administrators have the ability to configure the various layouts (e.g. record view, list view, etc.) available via Studio. The following are some of the options available to administrators when configuring layouts in Studio.

Record views may be configured to display differently [based on the viewing user's role](#).

Panels

Every field on a layout is contained within a panel, which can be organized to contain groups of similar or related fields to assist in organization. Modules using the Legacy user interface will have fields grouped by default into the Overview and Other panels while modules using the Sidecar user interface will have the Business Card and Show More panels. You can change the panel header titles by clicking the Pencil icon to the right of the panel name.

Note: You can have the panel collapsed by default on the Record View, Edit View, or Detail View by marking the Collapse? checkbox to the far right of the panel header.

Record View layout (for Sidecar modules):

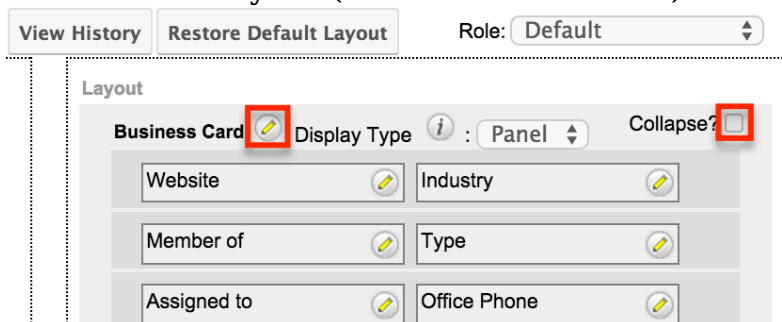

Edit View layout (for Legacy modules):

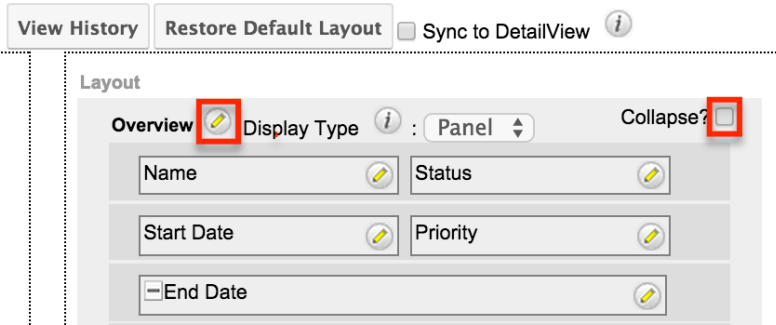

Tabs

Each of the panels (Business Card, Overview, etc.) may optionally be displayed as tabs in the layout. You can also nest panels within other panels defined as tabs. For example, if you set the Business Card panel as a "Tab" and leave "Show More" as a panel in the Record View layout, the Show More panel will appear within the Business Card tab.

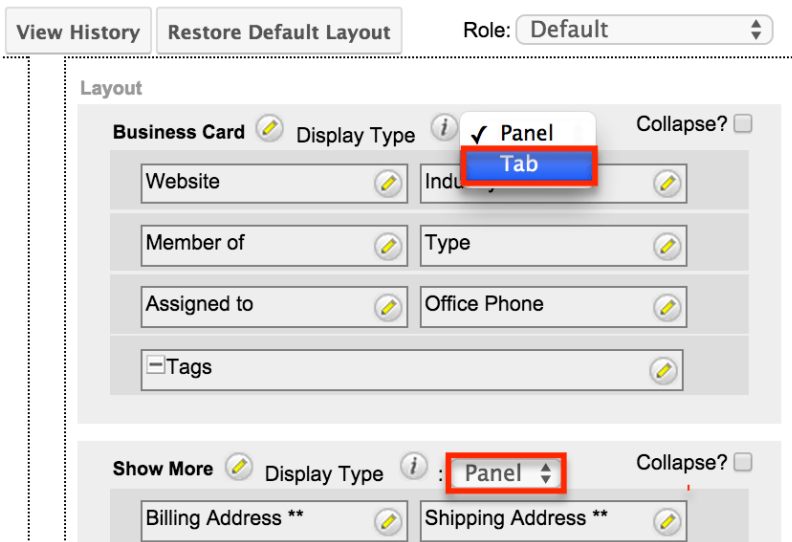

Every panel listed under a Tab display type will be a panel within the tab until the next Tab display type panel is reached. So if you add a new panel below "Show More" and set both the Business Card and Show More panel as "Tabs", then the newly added panel will appear within the Show More tab.

Restoring Layouts

Sugar keeps a history of the changes made to each layout. You can preview and restore historical layouts via "View History". For more information on viewing the history of layouts, please refer to the [Viewing Layout History](#) section of this documentation.

It is also possible to restore the Record View, Detail View, etc. layouts back to the

default out-of-the-box layout. For more information on how to reset a layout to default, please refer to the [Restoring Default Layouts](#) section in this documentation.

Note: When using role-specific record view layouts, the functionality of the Restore Default Layout button changes depending on which the Role dropdown's selection. Please refer to the [Restoring Customized Role-Views to the Default Role-View Layout](#) section for more information.

Sync And Copy (Legacy Modules)

Sugar provides administrators with the ability to sync and copy certain layouts to assist in configuring layouts. Often it makes sense for a module's edit view and detail view layouts to be identical. Instead of having to duplicate any changes made to one layout, administrators can configure the detail view layout to be synced to the edit view layout.

To sync the layouts, select the Sync to DetailView checkbox on the upper right of the EditView layout and click "Save & Deploy".



The current detail view layout will be replaced with the current edit view layout. At this point, changes cannot be made to the DetailView layout in Studio, but any changes made to the EditView layout will automatically be synced to the DetailView layout when saved.

As an alternative to syncing the layouts, administrators can copy the layout from the EditView to the DetailView or QuickCreate layouts. This is especially useful if you want the layouts to be similar, but different. Make any necessary changes to the EditView layout, then navigate to either the DetailView or QuickCreate layout. Select "Copy from EditView" to replace the current layout with details from the EditView layout. Once copied, you can continue to edit the DetailView layout as you wish.



Note: The copy feature is a one-time copy of the layouts. Any future changes to the EditView layout will not be reflected on the DetailView layout without performing

the copy again.

Editing Layouts

You can add, remove, hide, etc. the fields for the available layouts in the module by selecting the specific layout under the Modules panel to edit. Please note that the List View, PopuView, and Search layouts have columns where you can designate fields users can and cannot see.

Record views may be configured to display differently [based on the viewing user's role](#).

Editing Record View Layout

The following steps cover editing the Record View layout for the Accounts module as an example:

1. Expand "Layouts" from the Modules panel under the Accounts module and select "Record View". The Record View layout will display in the main panel to the right.

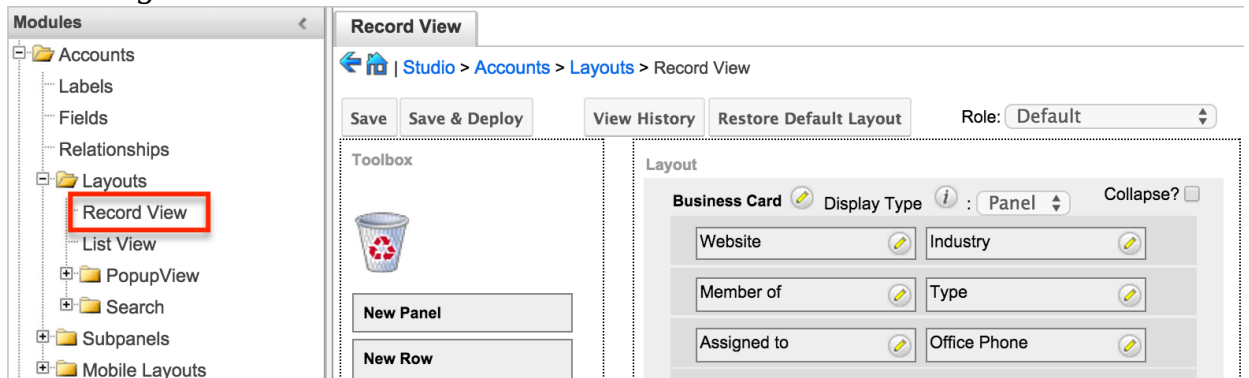

2. To add a field to the Record View layout, drag the field from the list of fields in the Toolbox to a "(filler)" location on the layout per your preference.
 - You can also drag a field to a location on the layout that already has a field in place. The newly added field and the existing field on the layout will swap places.

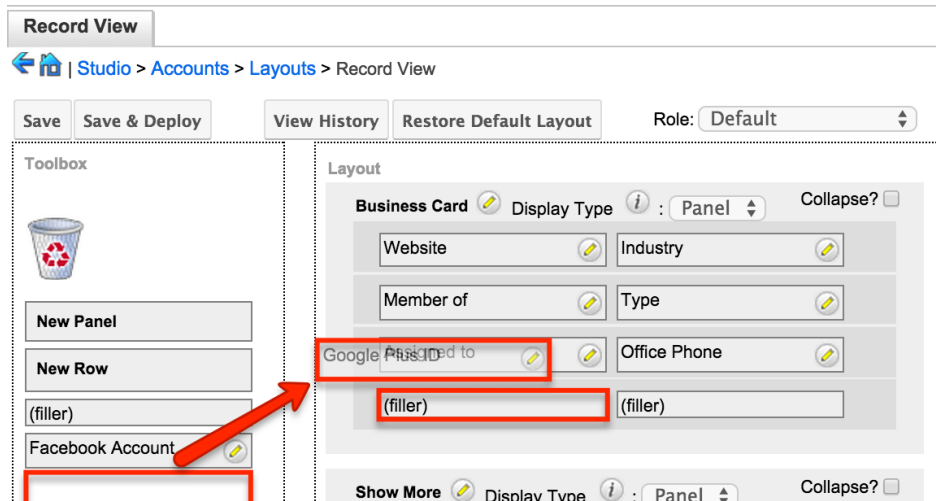

- To remove a field from the layout, drag and drop the field from the layout to the trash bin in the toolbox to remove the field from the layout. You may remove an entire row in the layout using the same method.

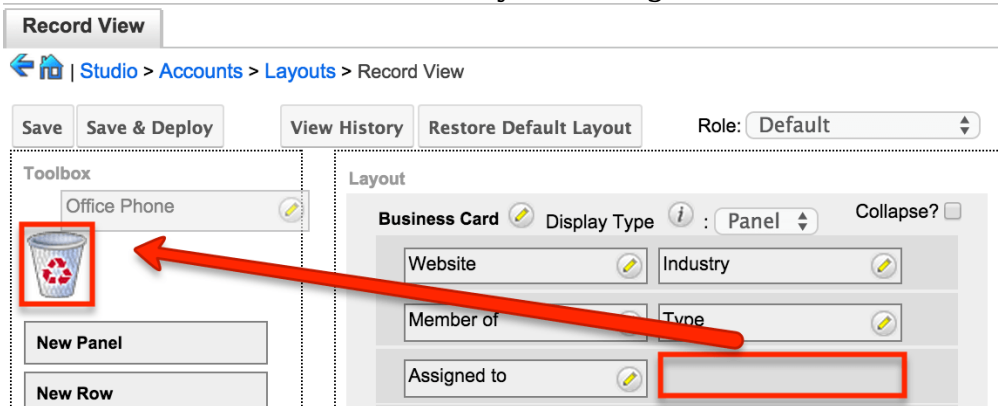

- To expand or minimize the field column in the layout, click the Plus icon (+) to stretch the field over two columns or click the Minus icon (-) to fit the field into one column. Some fields with content that can become long (e.g. Comment Log) are better suited to being displayed across two columns. **Note:** The layout will display a "(filler)" if there is no field in that location.

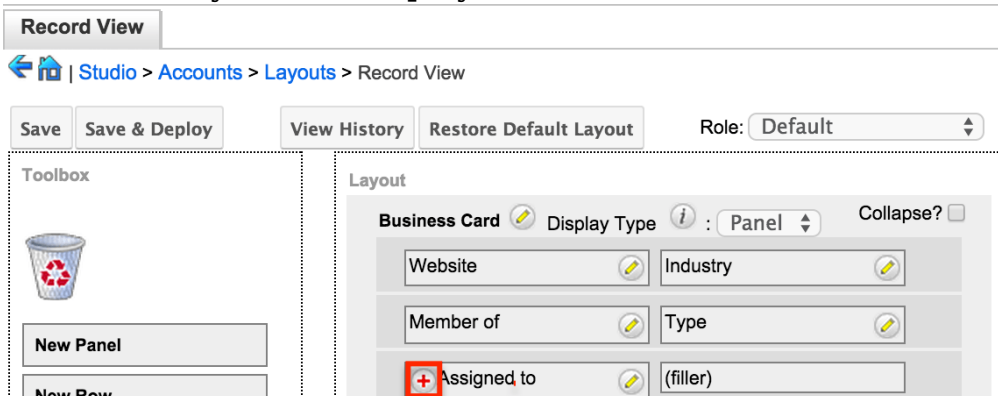

- To add a new row, drag the "New Row" item in the Toolbox to the layout to allow additional fields or blank spaces to be added.

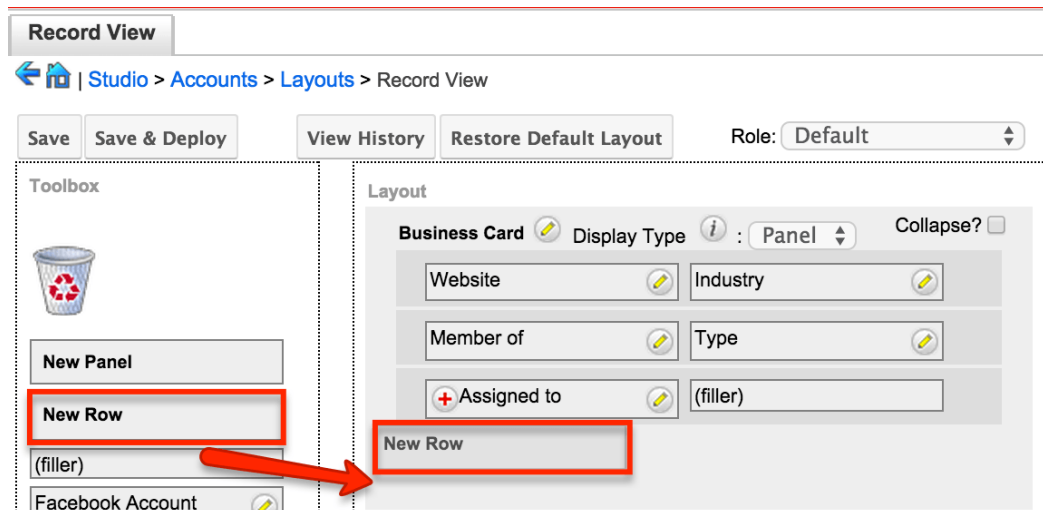

- To add a new panel, drag the "New Panel" item in the Toolbox to the layout to group different sets of fields together in the Record View layout.

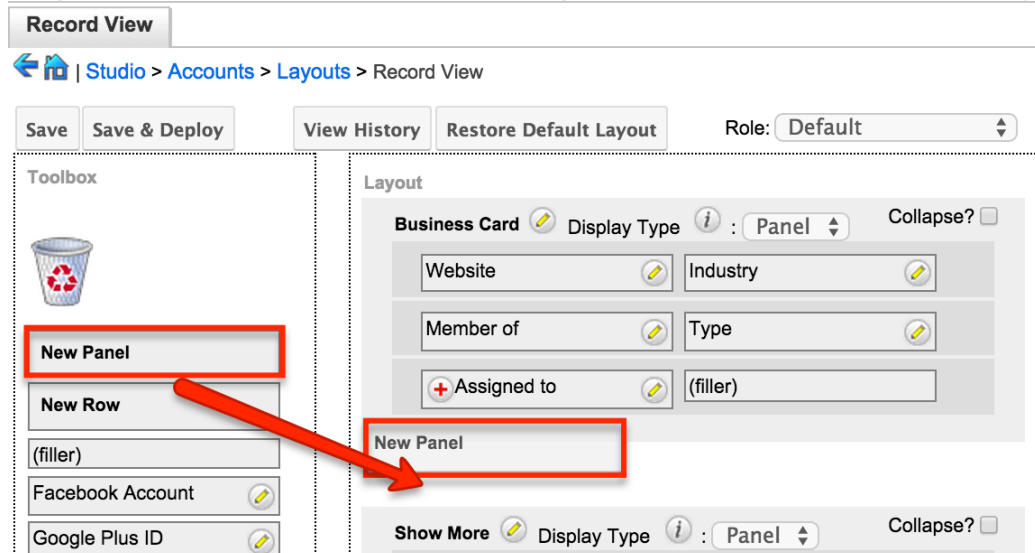

- Once the layout is finalized, click "Save & Deploy" to preserve your changes and deploy immediately.
 - You can click "Save" if you wish to preserve the changes made but not deploy to Sugar's user interface.

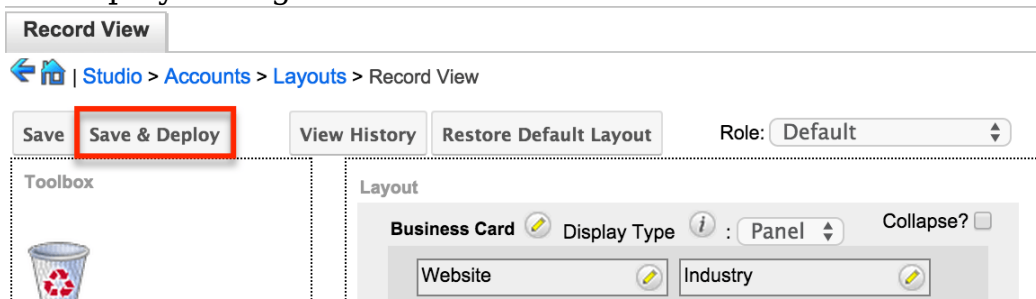

Note: It is recommended that dependent fields be placed below and/or to the right of the independent field in order to preserve the correct display of fields on the layout.

Creating Role-Based Record View Layouts

Record Views can be configured to display customized layouts based on the viewing user's role. The availability and organization of fields may be altered to provide only the relevant fields for each user's role according to your business practices. When editing a particular module's record view, the Role dropdown appearing on the top right contains all existing roles in the Sugar application. By default, none of the Sugar roles have customized views, so changes made to the Default role-view will automatically be copied to the other role-views upon save. This means that as long as no role-views are customized here, all users will continue to see the record view layout matching the Default role-view.

Note: It is recommended to assign each user to a maximum of one role. Users belonging to multiple roles which each have customized role-views may experience unexpected behavior when using record views. For more information about roles, please refer to the [Role Management](#) documentation.

Note: Role-based customizations to record views are included when exporting customizations from Studio. For more information, please refer to the [Exporting Role-Based Customizations](#) section and the [Module Loader](#) documentation.

If you wish to cause certain roles to use a modified record view for a module (e.g. Accounts), navigate to Admin > Studio > Accounts > Layouts > Record View and select the desired role from the Role dropdown to make changes specific to that role (e.g. Marketing Administrator).

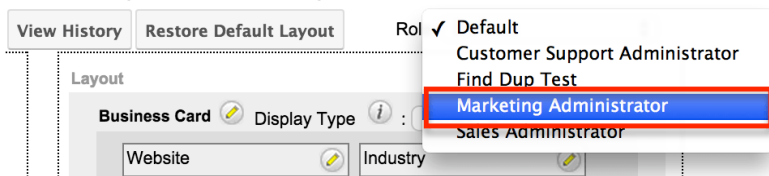

When viewing a Sugar role's role-view (e.g. Marketing Administrator), you have the option add, remove, and rearrange fields and panels. You may manipulate the layout as described in the [Editing Record View Layout](#) section above. The inclusion and location of fields will be specific to the role-view you are customizing. However, changes made to a field's display label from any of the role-views will update that field's display label on all role-views.

Once you have saved a modification to a role-view, it is considered customized and will display an asterisk (*) next to the role's name in the Role dropdown. Adding, removing, and rearranging fields or panels on the Default role-view will no longer have any effect on customized role-lists.

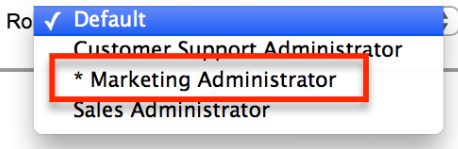

Note: Role-based views are not available for Legacy modules' detail views or any other sidecar layouts besides the record view. The Sidecar module must be available for editing in Studio for you to be able to create role-based record views for it.

Copying a Role-View From a Customized Role-View Layout

Customized role-view layouts may be copied to any other role-view except for the Default role-view.

1. Select the role-view you wish to alter in the Role dropdown
2. Click "Copy from..." and select the customized role-view you wish to duplicate.

Note: The Copy from... button will only appear when a customized role-view is available to be copied.

3. Click "Copy" and save.

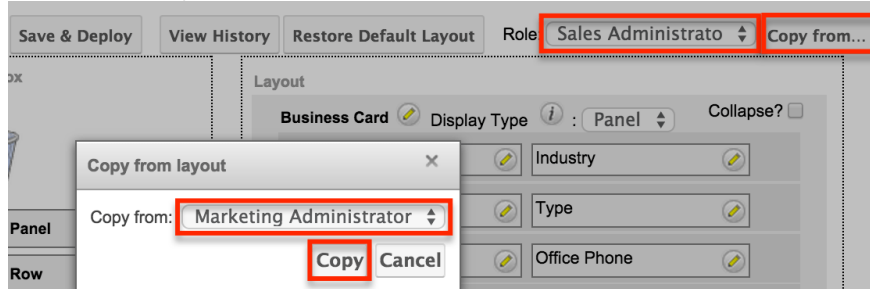

This will update the role-view to match the copied layout, and the role-view will now be considered customized and display an asterisk (*) next to the role's name in the Role dropdown.

Restoring Customized Role-Views to the Default Role-View Layout

The Restore Default Layout button may be used to bring a customized role-view back to the Default role-view's layout.

1. Select the customized role-view in the Role dropdown.
2. Click "Restore Default Layout" and save.

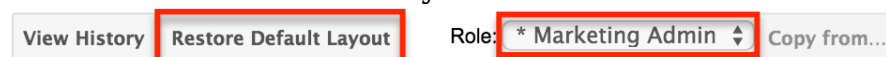

This will re-establish the link between the selected role-view and the Default role-view so that changes to the Default role will once again be automatically applied to the selected role-view. This will also remove the asterisk from the selected role-view's name in the Role dropdown since it is no longer considered customized.

Restoring the Default Role-View to the System Default Layout

The Restore Default Layout button can also be used to bring the Default role-view back to the system stock record view layout.

1. Select the Default role-view in the Role dropdown
2. Click "Restore Default Layout" and save.



This will remove any Studio changes to the layout so that it once again matches the system's stock layout. All other, non-customized role-views will also be updated to match.

Editing List View Layout

The List View layout has columns where you can define the fields that users can and cannot see. The List View layout also controls the list of available fields for the module's list view dashlet (e.g. My Contacts). Once the appropriate configurations are made in Studio, the deployed changes will be reflected in the Columns field of the corresponding module dashlet's Configuration Options page. Keep in mind that the module dashlet will not automatically reflect the Studio changes and users must edit the dashlet in order to view the changes, add new fields to the layout, etc.

To configure the List View layout, move the displayed fields among the Default, Available, and Hidden columns :

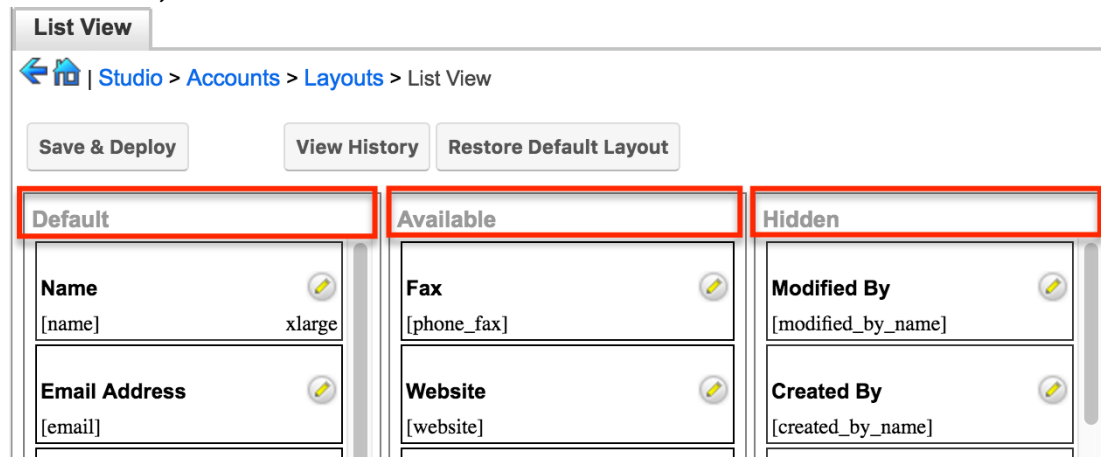

- **Default** : Drag fields into the Default column to display them on the default List view layout. The top-to-bottom order of fields corresponds with the left-to-right presentation of columns on the list view (or right-to-left for users viewing an RTL language). For example, the topmost field in the default column will be shown in the leftmost column of the list view.
- **Available** : Drag fields into the Available column to make them available for users to personalize their view of the layout without making them part of the default layout. Users will be able to click the Column Selection icon to see the list of available fields. For more information on working with columns in the list view, please refer to the [User Interface](#) documentation.
 - **Note:** Not all list-type layouts have an Available fields section.
- **Hidden** : Drag fields into the Hidden column to hide them from users in the list view. Hidden fields will be unavailable in list view regardless of a user's team or role settings, but they may still be available to users in other places such as in reports or the record view.

Note: To enable fields as filters in a Sidecar module's list view and list view dashlet (e.g. the "My Contacts" dashlet), please refer to the [Editing Search Layout](#) section.

The following steps cover editing the List View layout as an example:

1. Expand "Layouts" from the Modules panel under the Accounts module and select "List View".

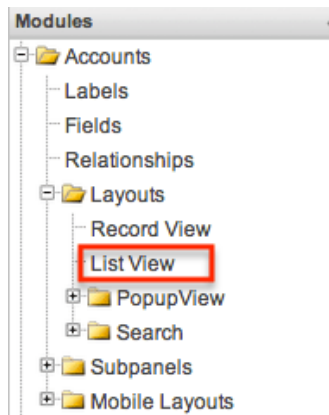

2. To add a field to the List View layout, drag and drop the fields from the Hidden column to the Default column.
 - **Note:** The fields in the Default column will be available to add as display columns in the corresponding module dashlet (e.g. My Accounts).

3. To remove a field from the layout, drag and drop the field from the Default column to the Hidden column.
4. To change the left-to-right order of the fields displayed on the list view, drag and drop fields up or down within the Default list.
 - **Note:** The order of fields designated for the List View layout also affects the order for the list of available fields in the corresponding module dashlet (e.g. My Accounts).
5. Optionally, modify the label and width for the field. Click the Pencil icon next to each field, enter the new label or select the width (e.g. small, medium, large), then click "Save". Changes to a field's label will affect all List View layouts for this module. For more information on setting column widths, please refer to the [List View Column Widths](#) section.

6. Click "Save & Deploy" to preserve your changes and deploy immediately.

List View Column Widths

Administrators can easily set the column widths for specific fields when configuring the List View layout. You can choose from a pre-defined list of width sizes (e.g. small, medium, large) that are available out-of-the-box with Sugar or

enter a custom width value. The custom width value should be entered in pixels (e.g. 200) for Sidecar modules. Legacy modules should be entered as a percentage (e.g. 40) of the total width of the list view that should be dedicated to the column.

The following table describes the available column width sizes for fields in Sugar's list-view layouts. The Approximate Characters column indicates the maximum number of characters that the column will display before indicating overflow with an ellipsis. For example, a column size with an Approximate Characters value of 4 would display "University of Miami" as "Univ...". This number is an approximation due to the various widths of characters in the alphabet (e.g. a "w" character occupies more horizontal space than an "i" character). Users may expand the default column width manually or hover over the ellipses to reveal the field's entire contents.

Name	Width	Approximate Characters
xxsmall	20px	1
xsmall	40px	2
small	68px	8
medium	128px	15
large	180px	30
xlarge	280px	50
xxlarge	460px	85

Note: For currency fields, Sugar enforces a minimum 141px column width. Therefore, only the "large" setting and above will apply and custom values must be defined as 141 or wider.

Editing Search Layout

The Search layout controls which fields are available as filters in a module's list view or list view dashlet. You edit the Search layout in the same fashion as the [List View layout](#), but using only the Default and Hidden columns. Fields placed in the Default column will be available as filters for users in the module's list view and list view dashlet; fields placed in the Hidden column will not. For more information on dragging and dropping fields between the Default and Hidden columns, please refer to the [Editing List View Layout](#) section of this page.

Note: After an administrator edits the Search layout for a module in Studio, users must edit or re-create their list view dashlets to see the deployed changes to their available filters or columns.

Editing Record View Dashlet Layout

The [Record View dashlet](#) layout can be configured in Studio for the Accounts, Cases, and Opportunities modules only. You edit the Record View dashlet layout in the same fashion as the [Record View layout](#). The only exception is that the Comment Log field cannot be added to the dashlet's layout. However, the [Comment Log dashlet](#) can be used instead to view the Comment Log on a dashboard.

Note: The Record View and Comment Log dashlets are only available to Sugar Serve and Sugar Sell users. For more information, refer to the [License Types](#) documentation.

Editing Convert Lead Layout

The Convert Lead layout in Sugar is structured differently from the other layouts as it is specific to the lead conversion page for the Leads module. Administrators can configure which modules are available to convert, mark modules as required, add modules to the Convert Lead page, etc.

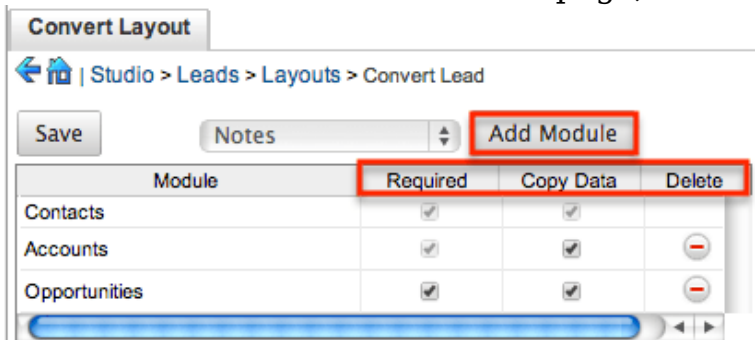

The following settings are available when configuring the Convert Lead layout:

- **Required** : Makes the module required during lead conversion. Required modules must be created or selected on the Convert Lead page in order for the lead to be converted and saved.
- **Copy Data** : Copies data from the Leads fields (stock and custom) to fields with the same name in the newly created record for the module.
 - **Note:** The field name and type must match between both modules (e.g. Leads and Accounts) in order for the data to copy over.
- **Delete** : Removes the module from the Convert Lead layout.

The following steps cover adding the Notes module to the Convert Lead layout:

1. Select the Notes module from the dropdown list above the convert lead

table then click "Add Module".

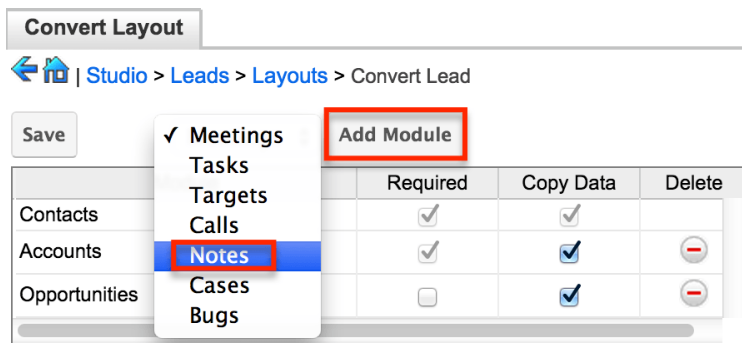

2. The Notes module will appear in the convert lead table and you can configure the settings as necessary. Click "Save" to preserve your changes.
 - **Note:** Modules added to the Convert Lead layout can be re-arranged by dragging and dropping the row (e.g. Notes) within the table. The Contacts, Accounts, and Opportunities modules cannot be re-arranged on the layout.

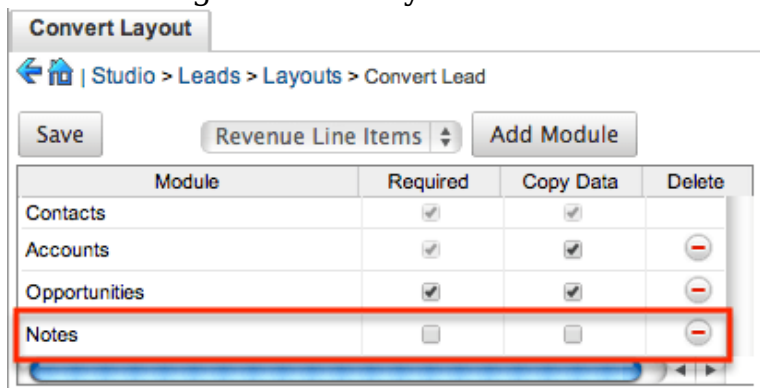

Subpanels

Related records between modules in Sugar are commonly displayed in Subpanels. Similar to list type layouts, administrators can modify the subpanel layouts to change which fields are shown in a module's subpanel. You can add or remove fields for these subpanels depending on the information you want to be displayed to users. You can also rename a subpanel if needed. To access the subpanels section in Studio, expand "Subpanels" from the Modules panel under the desired module and the available subpanels will appear. Please note that the list of available subpanels for each module will vary.

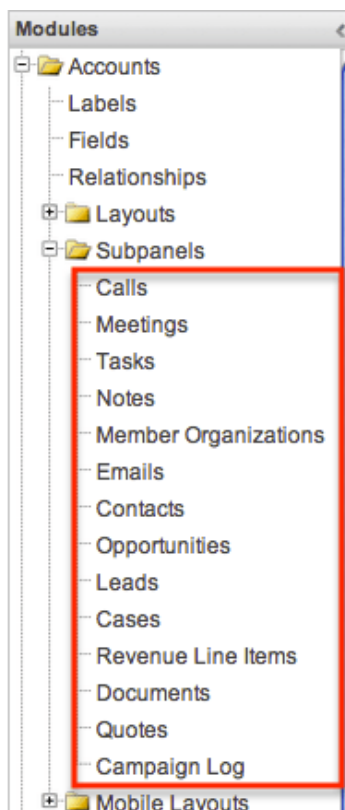

Subpanel Options

When configuring the Subpanel layout in Studio, there are options which allow you to change the subpanel title, view historical layout changes, as well as restore the default layout.

The following options are available when configuring subpanels in Studio:

- **Subpanel Title** : Sugar administrators have the option to modify the name of the subpanel. This will change the display value of the subpanel when viewing the record view (for Sidecar modules) or detail view (for Legacy modules) of a record from the specified module.
- **View History** : Sugar keeps a history of the changes made to each subpanel. You can preview and restore historical layouts via "View History". For more information on viewing the history of subpanels, please refer to the [Viewing Layout History](#) section of this documentation.
- **Restore Default Layout** : Restores the subpanel layout back to the default out-of-the-box layout. For more information on how to reset a subpanel to the default layout, please refer to the [Restoring Default Layouts](#) section of this documentation.

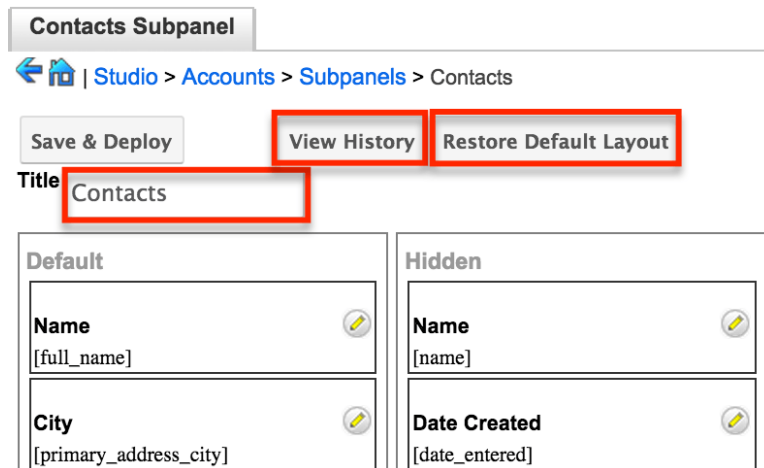

Editing Subpanels

The following steps cover editing the Notes subpanel for the Cases module as an example:

1. Expand "Subpanels" from the Modules panel under the Cases module and select "Notes". The Notes subpanel layout will display in the main panel to the right.

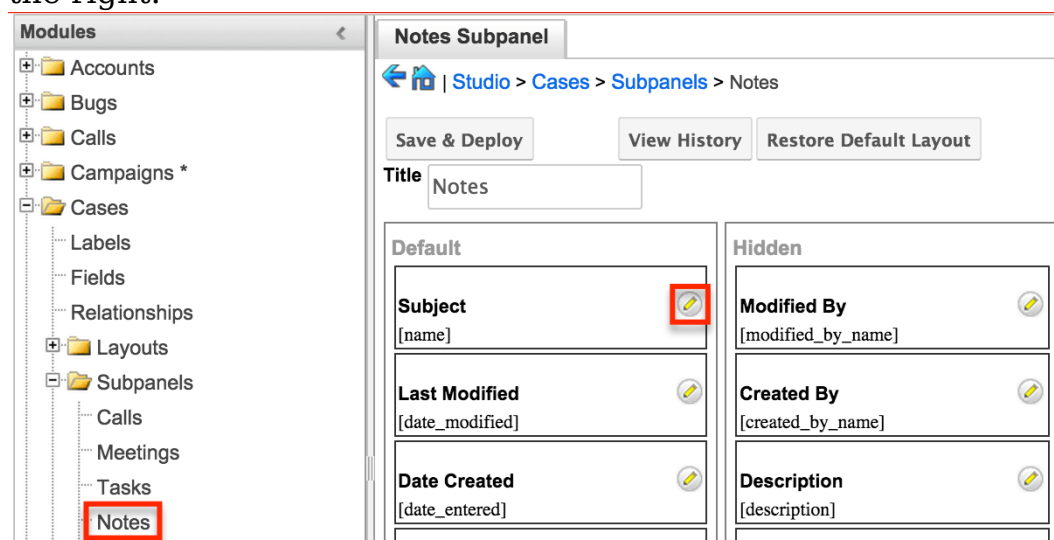

2. To add a field to the Subpanel layout, drag and drop the fields from the Hidden column to the Default column. You can then drag the field up and down the list to change the position of the field in the subpanel.

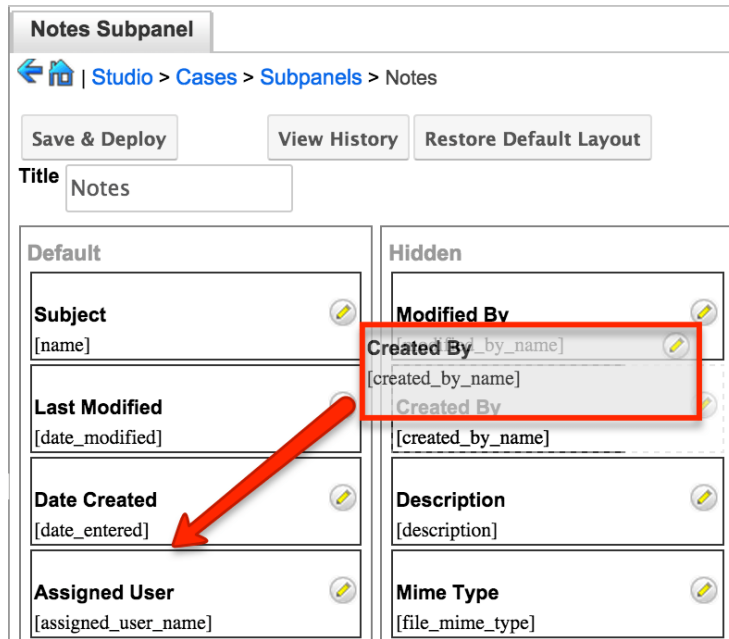

- To remove a field, drag and drop the fields from the Default column to the Hidden column.

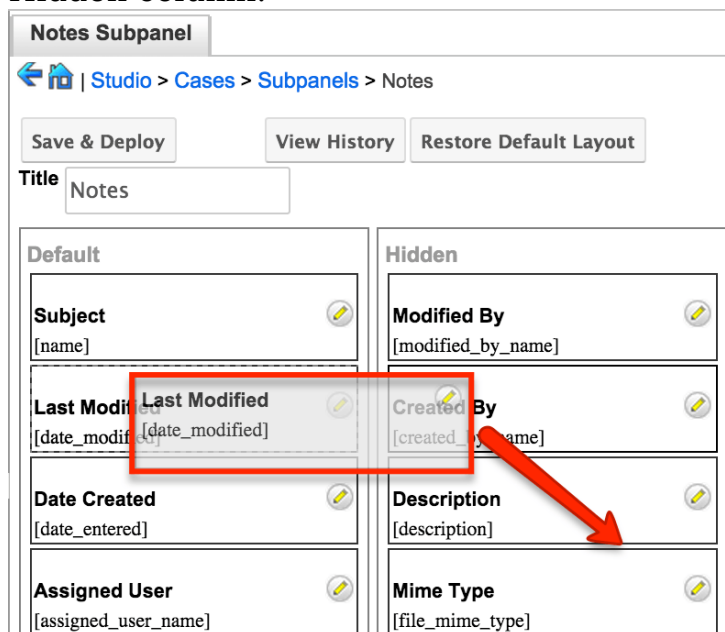

- Click the Pencil icon to change the column width of the field in the subpanel.
 - Note:** Administrators can choose from a pre-defined list of width sizes (e.g. default, small, medium, etc.). Please note that selecting the Default width will set the list view column to equal the Medium width size. Selecting "custom" from the list will allow you to enter a custom width value in the open box. The custom width value should be entered in pixels (e.g. 200) for Sidecar modules. Legacy modules should be entered as a percentage (e.g. 40) of the total width of the list view that should be dedicated to the column.
 - When defining the column width for currency fields (e.g. Likely, Best, etc.), only "large" and above applies because there is a

minimum width requirement in Sugar for this field type. In addition, when defining a custom width for currency fields, the value must be 141px or wider.

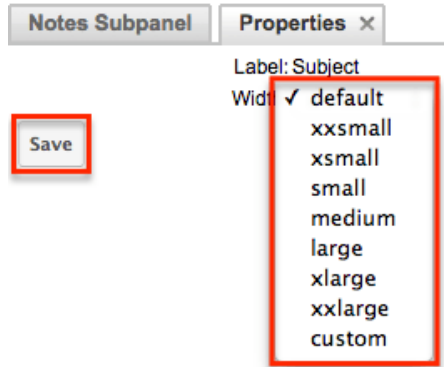

5. Click "Save & Deploy" to preserve your changes and deploy immediately.

Mobile Layouts

Mobile layouts are used to represent the views in Sugar Mobile. The mobile layouts section in Studio allows administrators to add fields and configure the various mobile layouts. To access the mobile layouts section in Studio, expand "Mobile Layouts" from the Modules panel under the desired module. The available mobile layouts for the selected module will appear under "Mobile Layouts".

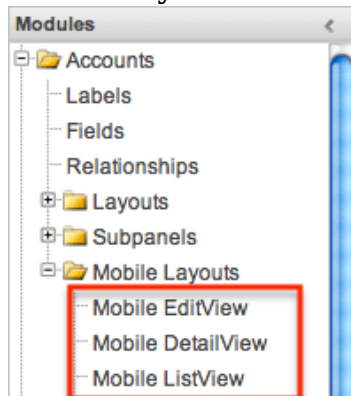

Mobile Layout Types

There are various mobile layouts in Sugar to represent the different areas of the Sugar Mobile application. Please note that not all layouts are available in every module and the different mobile applications will use the information defined here differently.

The following mobile layouts are available in Sugar:

-
- **Edit View** : Edit view layout is used to modify or create records in the specified module.
 - **Detail View** : Detail view layout is used to view the current data for a record within the specified module. Certain fields are translated to Sugar Mobile as buttons instead of data. For example, instead of seeing the phone number, there is a phone icon to be able to call the number on the record.
 - **List View** : List view layout is used to view multiple records within the specified module. Only the first two fields in the list view section will be displayed in Sugar Mobile.

Mobile Layout Options

Administrators have the ability to configure the various mobile layouts available via Studio.

The following options are available when configuring mobile layouts in Studio:

- **View History** : Sugar keeps a history of the changes made to each layout. You can preview and restore historical layouts via "View History". For more information on viewing the history of layouts, please refer to the [Viewing Layout History](#) section of this documentation.
- **Restore Default Layout** : Restores the mobile layout back to the default out-of-the-box layout. For more information on how to restore the default layout, please refer to the [Restoring Default Layouts](#) section in this documentation.
- **Role** : Record views may be configured to display differently based on the viewing user's role. For more information, please refer to the [Creating Role-Based Record View Layouts](#) section.

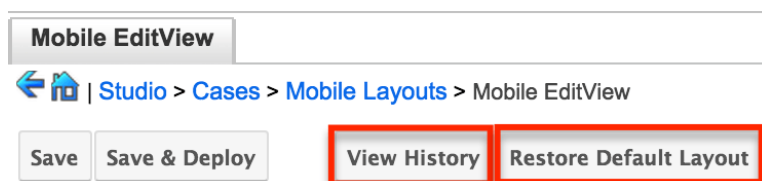

Editing Mobile Layouts

You can add, remove, hide, etc. the fields for the available layouts in "Mobile Layouts" by selecting the specific layout under the Modules panel to edit. Please note that the Mobile EditView and DetailView layouts are modified in similar fashions. The Mobile ListView layout has columns where you can designate fields users can and cannot see.

Mobile EditView and DetailView can both be configured to display customized layouts based on the viewing user's role. The availability and organization of fields may be altered to provide only the relevant fields for each user's role according to your business practices. For more information about configuring role-based layouts, please refer to the [Creating Role-Based Record View Layouts](#) section above.

The following steps cover editing the Mobile EditView layout for the Cases module as an example:

1. Expand "Mobile Layouts" from the Modules panel under the Cases module and select "Mobile EditView". The Mobile EditView layout will display in the main panel to the right.

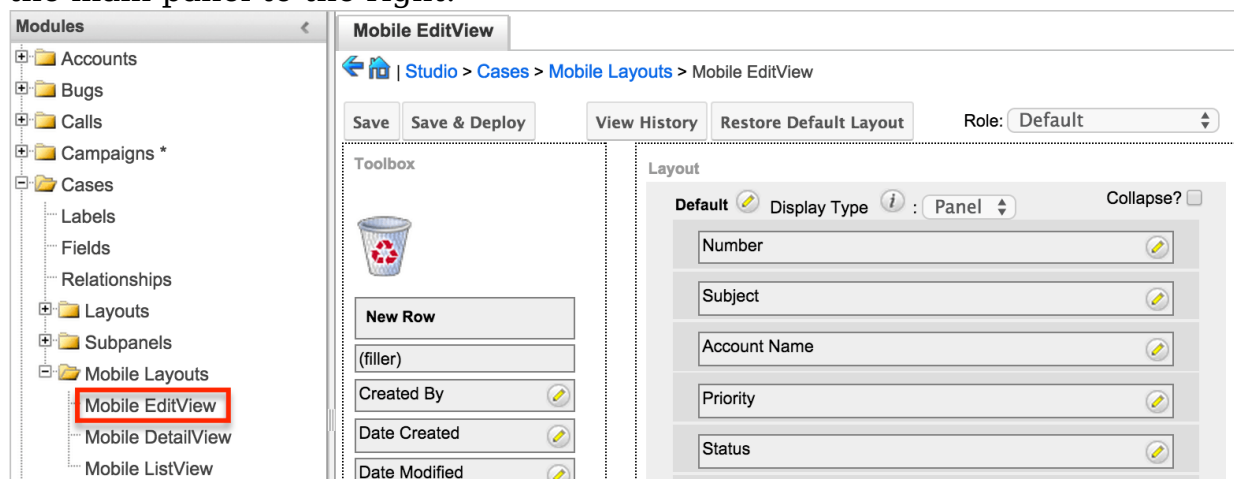

2. To add a field to the Mobile EditView layout, drag the field from the list of fields in the Toolbox to a "(filler)" location on the layout per your preference.
3. You can also drag a field to a location on the layout that already has a field in place. The newly added field and the existing field on the layout will swap places.

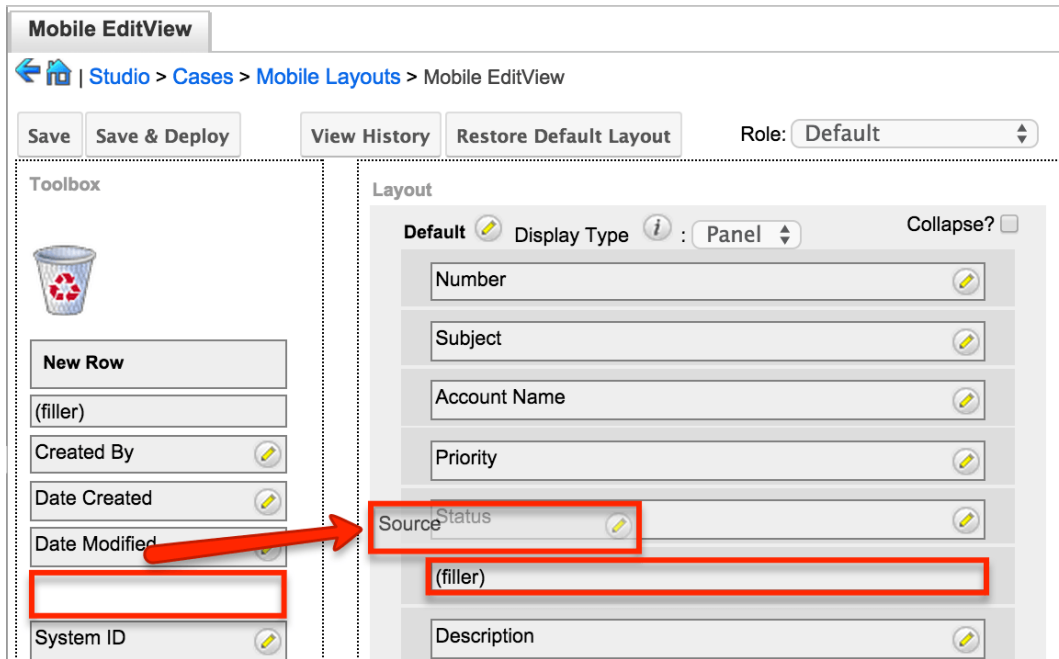

4. To remove a field from the layout, drag and drop the field from the layout to the trash bin in the Toolbox to remove the field from the layout. You may remove an entire row in the layout using the same method.

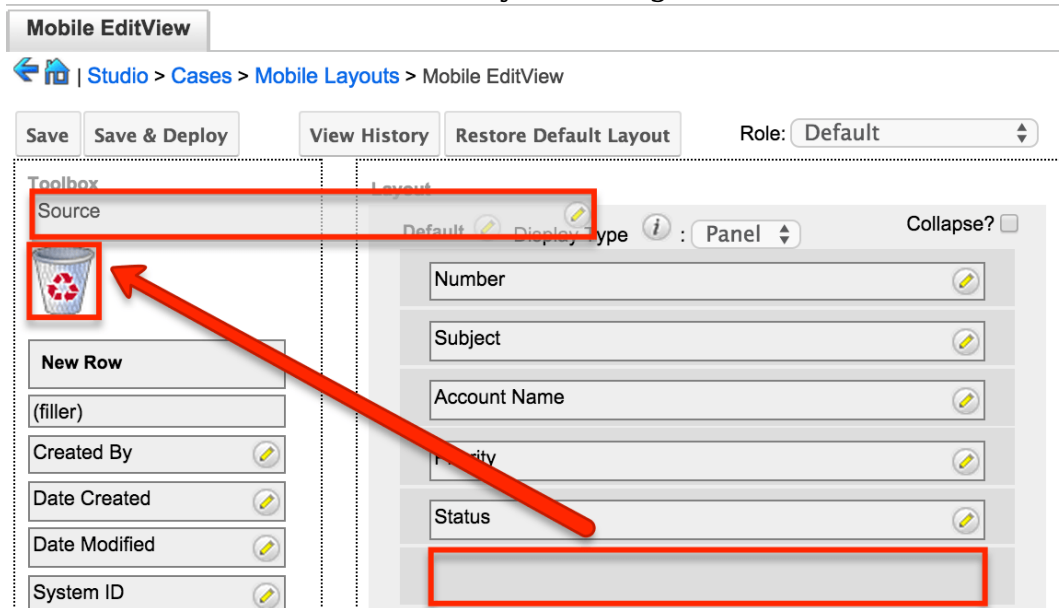

5. To add a new row, drag the "New Row" item in the Toolbox to the layout to allow additional fields or blank spaces to be added.

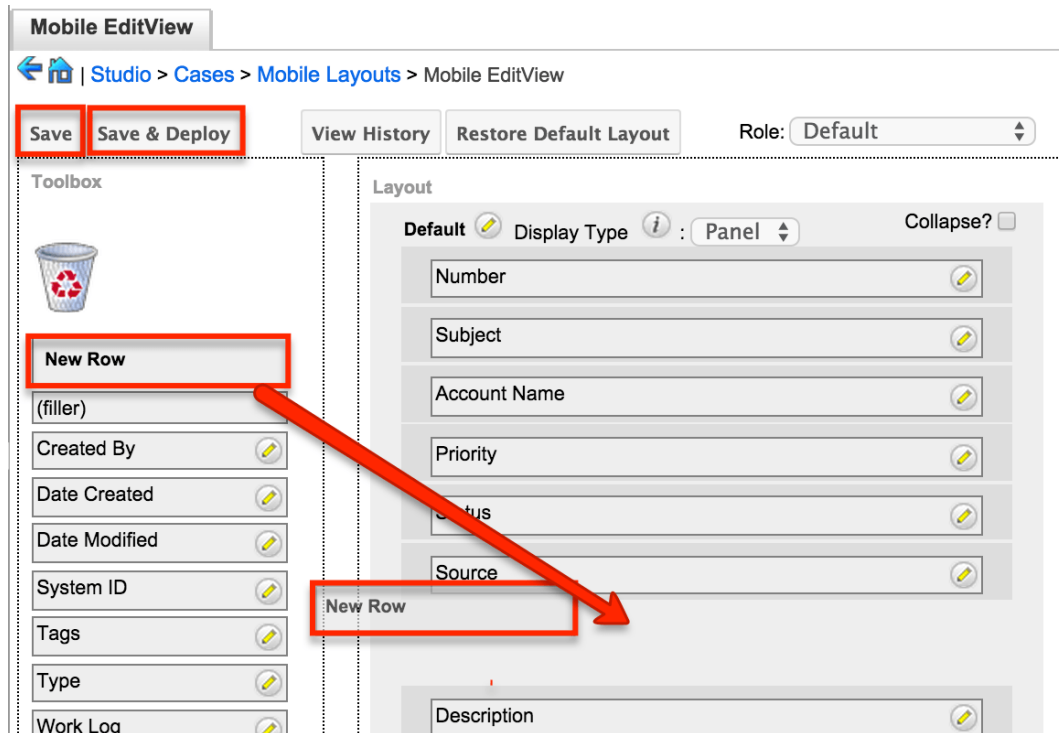

6. Once the layout is finalized, click "Save" to preserve your changes or "Save & Deploy" to preserve your changes and deploy them instantly.

Unlike the Mobile EditView layout, the Mobile List View layout has columns where you can designate fields users can and cannot see. When configuring the Mobile List View layout, you will see three columns (Default, Available, Hidden) where fields can be dragged and dropped accordingly.

- **Default** : This column contains fields that are displayed in the list view.
- **Available** : Available fields are fields that will not show by default in the layout, but if the layout can be personalized, users can add these fields to their view of the layout. Not all list type layouts have an available fields section.
- **Hidden** : This column contains fields that will not be displayed in the list view.

The following steps cover editing the Mobile List View layout as an example:

1. Expand "Layouts" from the Modules panel under the Cases module and select "Mobile List View".

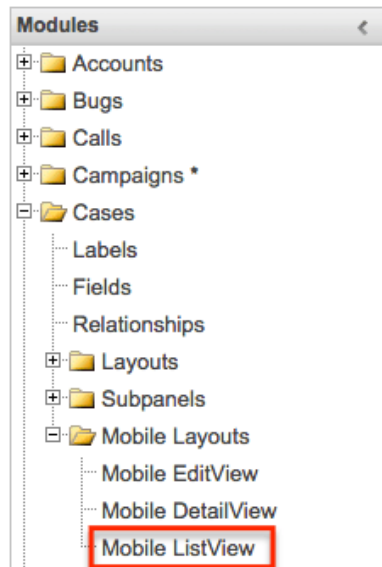

- To add a field to the Mobile ListView layout, drag and drop the fields from the Hidden column to the Default column.

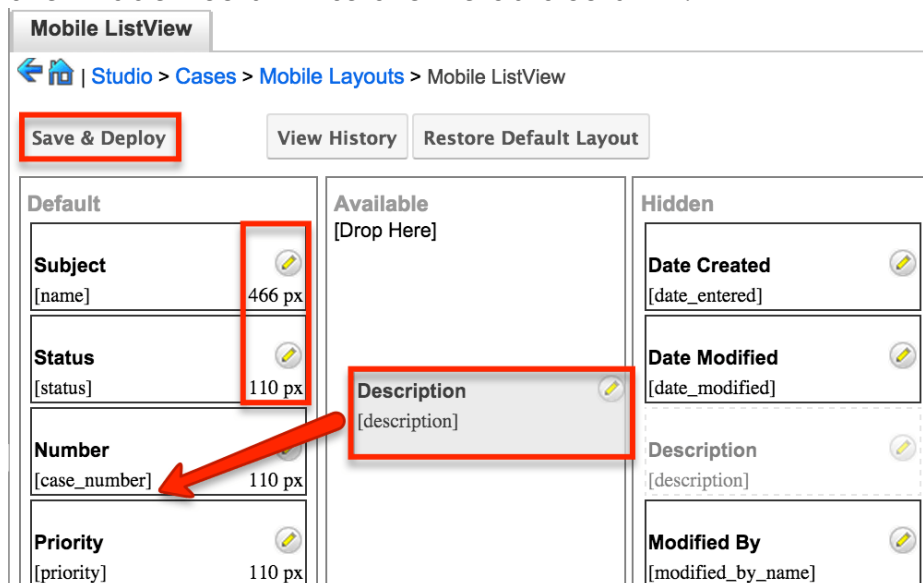

- Click the Pencil icon to modify the label of the field as well as the width size the field will take up in the list view. Please note that the modified label will display in all List View layouts.
- Click "Save & Deploy" to preserve your changes and deploy immediately.

Using Sugar Logic

Sugar Logic allows administrators to write simple formulas and logic checks to provide a calculation for a field or to set the visibility of a field. For more information regarding the types of field that you can use Sugar Logic in, please refer to the [Field Options](#) section of this documentation. A calculated field uses a formula to derive its value based on the values of other fields as well as mathematical or logical operators. A dependent field uses a formula to determine

whether or not the field should be displayed. These formulas are automatically recalculated when the record is updated. In addition, when a record containing a formula's input field is updated, the formula is automatically recalculated.

Note: When creating a calculated formula for a Currency field, the currency symbol should not be used for a value (e.g. \$100) in the formula. The formula should only define the numeric value (e.g. 100), as including the currency symbol will result in improperly calculated values.

When a calculated or dependent field is created or its formula is modified, all existing records in the module will not use the new formula until they have undergone a save action. To update the existing records to use the new formula, the module's list view includes a Recalculate Value action. Admin users or users with developer-level access can use this feature to cause existing records to recalculate affected fields without having to perform an update on each record individually. For more information, please refer to the [User Interface](#) documentation in the Application Guide.

Administrators can access the formula builder for the fields and options that accept formulas by selecting "Edit Formula".

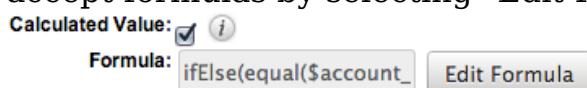

For more information and examples using Sugar Logic, please refer to the [Sugar Logic section of the Knowledge Base](#), which includes articles covering the use of dependent and calculated fields. Topics range from introductory information to example Sugar Logic formulas and detailed walkthroughs of how to construct various fields and formulas in the formula builder.

Functions

Functions are listed on the lower left-hand corner of the formula builder and provide a variety of calculations, logic checks, and formatting options. To locate the function you need, simply scroll through the list or enter search criteria to narrow the list.

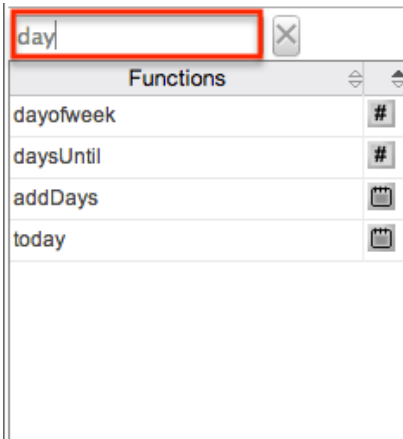

To see how to use a function, simply hover over the function to view the syntax, parameters, and a brief description of what the function does.

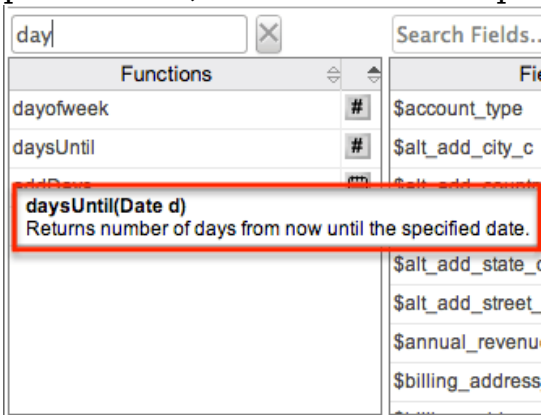

The function name is followed by a comma-separated list of parameters to the function. The list specifies the data type expected for each parameter. For example, the function "daysUntil" expects one parameter of Date type.

The description in the hover text will typically specify what data type is being returned, but if it does not, the symbol to the right of the function also represents the function's data type.

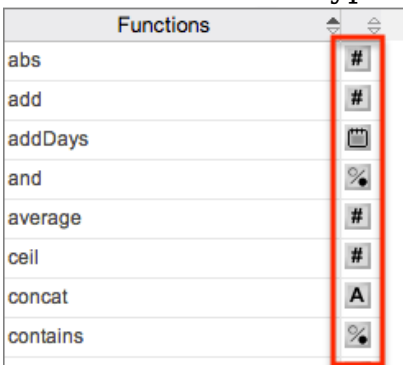

The following is a list of the possible return type symbols and the data types they return:

Symbol	Description
#	Returns a Number

Calendar	Returns a Date object with a date and time
%	Returns a Boolean (true or false) value
A	Returns Text
[]	Returns a List
?	Returns a variable data type that could be any of the above

List of Functions

Some functions require a given number of parameters while others are more flexible. Most parameters require a specific data type to be passed in for the function to work. Functions with the same data type can be nested in a single formula.

The following functions and their parameters (multiple parameters are represented by "...") are available in Sugar:

Function	Description	Parameters	Return Type
abs	Returns the absolute value of \$param1.	Number \$param1	Number
add	Returns the sum of the given parameters.	Number \$param1, ...	Number
addDays	Returns \$date moved forward or backwards by \$days.	Date \$date, Number \$days	Date
and	Returns true if and only if all given parameters are true.	Boolean \$param1, ...	Boolean
average	Returns the average of the given parameters.	Number \$param1, ...	Number
ceil	Returns \$param1 rounded up to the next integer.	Number \$param1	Number

concat	Returns all of the given parameters appended together in the order passed.	String \$param1, ...	Text
contains	Returns true if \$needle is within \$haystack.	String \$haystack, String \$needle	Boolean
count	Returns the number of records related to this record by \$module	Relate \$module	Number
countConditional	Returns the number of records related to this record by \$link and that match the value of a specific field.	Relate \$link, Field \$string, Values \$list	Number
createList	Returns a List of the given parameters.	Generic \$param1, ...	List
date	Returns \$param1 as a Date object.	String \$param1	Date
dayofweek	Returns the number of the day of week that \$param1 falls on.	Date \$param1	Number
daysUntil	Returns the number of days from now until \$param1.	Date \$param1	Number
divide	Returns the \$numerator divided by the \$denominator.	Number \$numerator, Number \$denominator	Number
equal	Returns true if \$param1 is equal to \$param2.	Generic \$param1, Generic \$param2	Boolean
floor	Returns \$param1 rounded down to the next integer.	Number \$param1	Number
forecastIncludedCo	Returns all the		List

mmmitStages	included commit stages for the Forecast module.		
forecastSalesStages	Returns all the included sales stages for the Forecast module from the sales_stage_dom; If you pass in "false" for the \$includeWon or \$includeLost, those values will not be returned in the list.	Boolean \$includeWon, Boolean \$includeLost	List
getDropdownKeySet	Returns a List of the keys in the dropdown named \$param1. This list must be defined in the Dropdown editor.	String \$param1	List
getDropdownValue	Returns the value for the \$key found in the dropdown named \$list. This list must be defined in the Dropdown editor.	String \$list, String \$key	Text
getDropdownValueSet	Returns a List of the values in the dropdown named \$param1. This list must be defined in the Dropdown editor.	String \$param1	List
getListWhere	Returns the matched array from lists.	String \$trigger, Enum \$lists	List
greaterThan	Returns true if \$param1 is greater than \$param2.	Number \$param1, Number \$param2	Boolean
hoursUntil	Returns the	Date \$param1	Number

	number of hours from now until \$param1.		
ifElse	Returns \$return1 if \$condition is true or \$return2 if \$condition is false.	Boolean \$condition, Generic \$return1, Generic \$return2	Variable
indexOf	Returns the position of \$needle in \$haystack or -1 if \$haystack does not contain \$needle. The index starts at 0.	Generic \$needle, List \$haystack	Number
isAfter	Returns true if \$param1 is after \$param2.	Date \$param1, Date \$param2	Boolean
isBefore	Returns true if \$param1 is before \$param2.	Date \$param1, Date \$param2	Boolean
isForecastClosed	Returns true if \$status is in the forecast config for sales_stage_won or sales_stage_lost	String \$status	Boolean
isForecastLost	Returns true if \$status is in the forecast config for sales_stage_lost	String \$status	Boolean
isForecastWon	Returns true if \$status is in the forecast config for sales_stage_won	String \$status	Boolean
isInList	Returns true if \$needle is contained within \$haystack.	Generic \$needle, List \$haystack	Boolean
isValidDate	Returns true if \$param1 is a valid date string.	String \$param1	Boolean
isValidEmail	Returns true if \$param1 is in a	String \$param1	Boolean

	valid email address format.		
isWithinRange	Returns true if \$value is greater than or equal to \$min and less than or equal to \$max.	Number \$value, Number \$min, Number \$max	Boolean
ln	Returns the natural log of \$param1.	Number \$param1	Number
log	Returns the \$base Log of \$value.	Number \$value, Number \$base	Number
max	Returns highest value of the given parameters.	Number \$param1, ...	Number
maxRelatedDate	Returns the highest value of \$field in records related to \$module.	Relate \$module, String \$field	Date
median	Returns the median of the given parameters.	Number \$param1, ...	Number
min	Returns lowest value of the given parameters.	Number \$param1, ...	Number
monthofyear	Returns the number of the month that \$param1 is in.	Date \$param1	Number
multiply	Returns the value of the given parameters multiplied together.	Number \$param1, ...	Number
negate	Returns the negated value of \$param1.	Number \$param1	Number
not	Returns true if \$param1 is false, and false if \$param1 is true.	Boolean \$param1	Boolean
now	Returns a Date object representing		Date

	today's date and the current time.		
number	Returns the numeric value of \$param1.	String \$param1	Number
or	Returns true if any given parameters are true.	Boolean \$param1, ...	Boolean
pow	Returns the \$value raised to the power of \$exponent.	Number \$value, Number \$exponent	Number
related	Returns the value of \$field in the related \$module.	Relate \$module, String \$field	Variable
rollupAve	Returns the average value of \$field in records related to \$module.	Relate \$module, String \$field	Number
rollupConditionalSum	Returns the sum of the values of \$field in records related by \$link where \$conditionField contains something from \$conditionalValues.	Relate \$link, String \$field, String \$conditionField, List \$conditionalValues	Number
rollupMax	Returns the highest value of \$field in records related to \$module.	Relate \$module, String \$field	Number
rollupMin	Returns the lowest value of \$field in records related to \$module.	Relate \$module, String \$field	Number
rollupSum	Returns the sum of the values of \$field in records related to \$module.	Relate \$module, String \$field	Number
strlen	Returns the number of characters in \$param1.	String \$param1	Number

strToLower	Returns \$param1 converted to lower case.	String \$param1	Text
strToUpper	Returns \$param1 converted to upper case.	String \$param1	Text
subStr	Returns the portion of \$value specified by \$start and \$length. The position starts at 0.	String \$value, Number \$start, Number \$length	Text
subtract	Returns \$param1 minus \$param2.	Number \$param1, Number \$param2	Number
timestamp	Returns the passed in datetime string as a unix timestamp.		Date
today	Returns a Date object representing todays date.		Date
toString	Returns \$param1 converted to a string.	Generic \$param1	Text
translateLabel	Returns the translated value of \$label for \$module.	String \$label, String \$module	Text
valueAt	Returns the value at position \$index in \$haystack.	Number \$index, List \$haystack	Variable

Fields

Fields are listed on the lower right-hand corner of the formula builder and contain the fields for the current module. Fields can be referenced in formulas and will start with a \$. To locate the field you need, simply scroll through the list or enter search criteria to narrow the list.

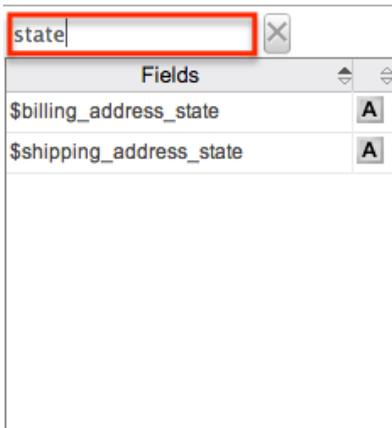

To add a field to the formula, simply click on the field to be added. The variable name for the field will be placed at the end of the formula. You can also type the variable names manually in the formula.

Related Field

Related fields are available to be added to formulas via the related function. You can manually add related function calls to your formula or you can build the syntax for the related function by clicking "Related Field".

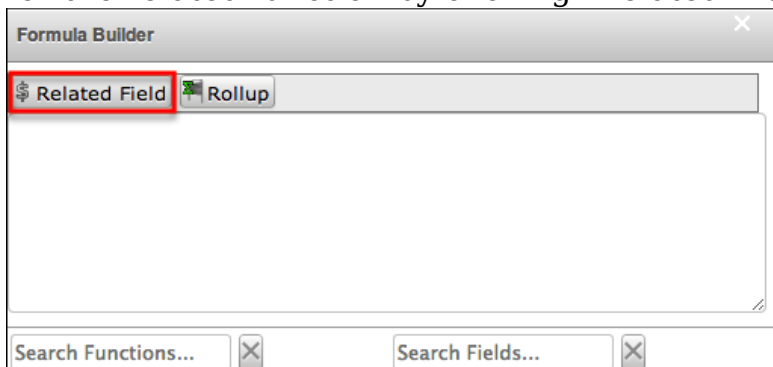

This will open a dialog box which will assist in building the syntax to use the related function. Select a module and a field within that module to pull the related field from and click "Insert".

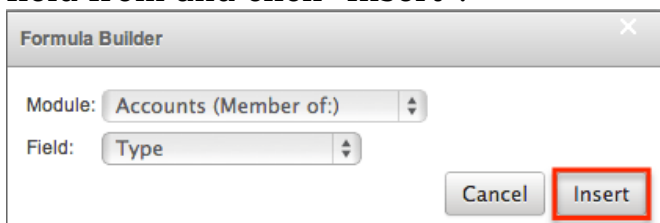

The resulting syntax for the selected options will be added to the formula.

Note: If a record has multiple related records to a module, the related function

will pull the field from one of the related records. It is not recommended to rely on the related function to pull the same related records for a many relationship.

Rollup

In addition to adding related fields, you can also add aggregate functions on related fields to formulas via the rollup functions. You can manually add rollup function calls to your formula or you can build the syntax for the rollup function by clicking "Rollup".

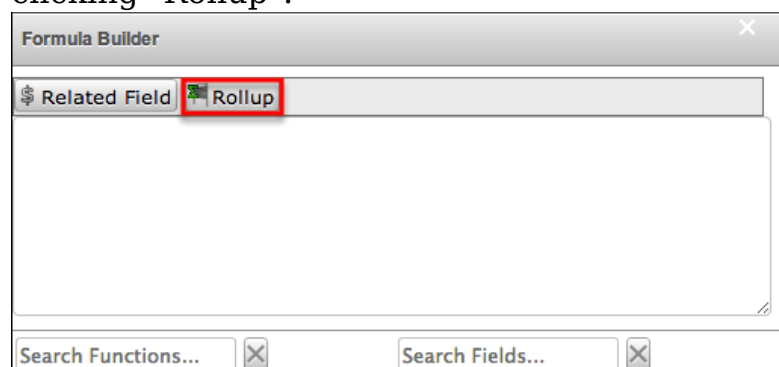

This will open a dialog box which will assist in building the syntax to use the rollup function. Select the type of rollup function (Sum, Average, Minimum, or Maximum) to perform on the module field. To perform a count of related records, please refer to the count function listed in the [Functions](#) section. Select a module and a field within that module to perform the rollup function on and click "Insert".

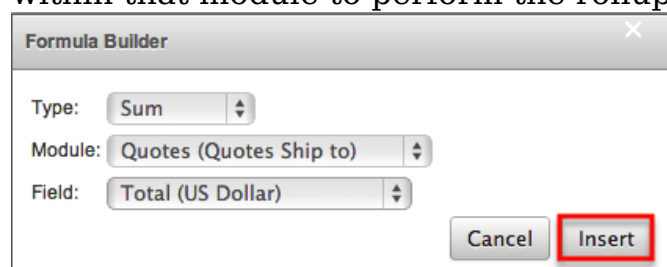

The resulting syntax for the selected options will be added to the formula.

Note: Rollup functions can only aggregate number type fields.

Viewing Layout History

Layouts, subpanels, and mobile layouts in Studio keep a history of the last ten changes made to the specific layout. To view the history for any of these layouts, simply select "View History" from the Record View (for Sidecar modules), List View, Edit View (for Legacy modules), etc. layout in Admin > Studio.

The following steps cover viewing the layout history for the Record View layout as an example:

1. Navigate to the [Record View](#) layout in Admin > Studio.
2. Click the View History button on the upper left of the layout editor.

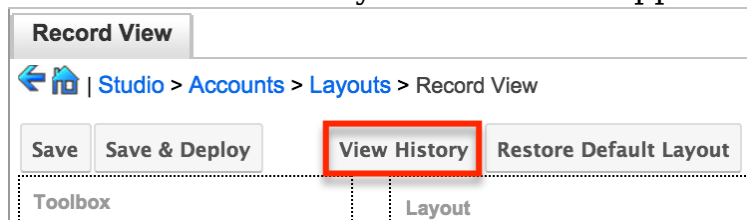

3. The History dialog box will appear showing the timestamps of the last ten saves to the selected layout.

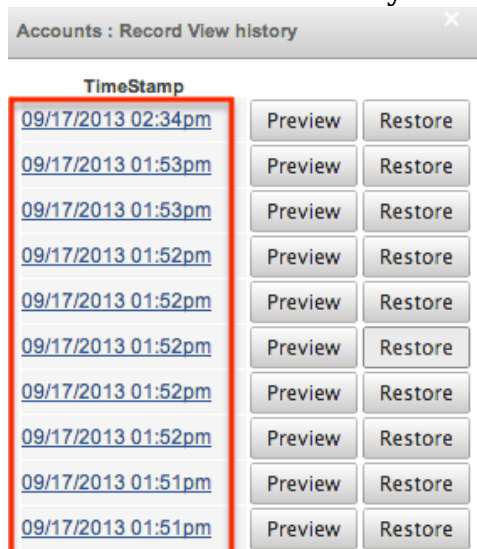

4. Click the timestamp or Preview button and a preview of the modified layout will appear in a new tab of the main layout panel.

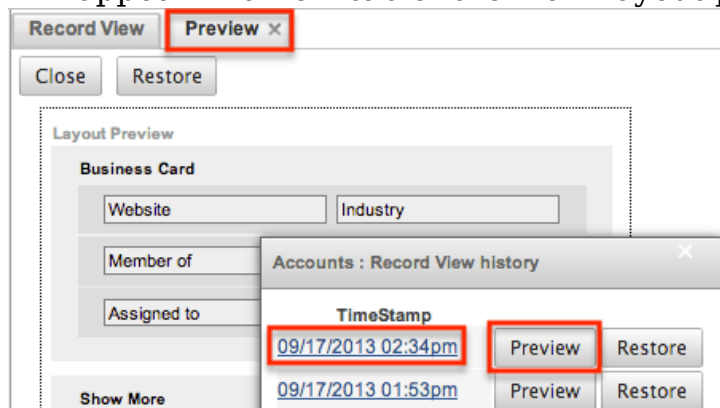

5. To restore a specific layout per the history, click the Restore button within the Preview layout or from the History dialog box.

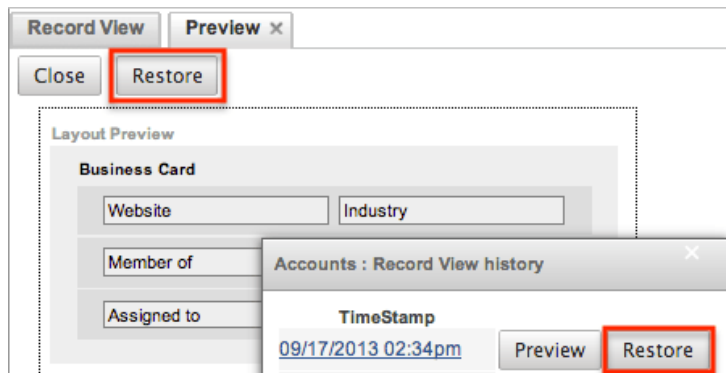

The chosen Record View layout will load into the editor and you may make appropriate changes to the layout as you wish. Click "Save" to preserve your changes or "Save & Deploy" to preserve your changes and deploy immediately.

Restoring Default Layouts

Various layouts in Studio can be restored back to the default out-of-the-box configuration, which will revert all changes made to the specific layout (e.g. list view, record view, etc.). To restore the default layout, simply click the Restore Default Layout button from the Record View (for Sidecar modules), List View, Edit View (for Legacy modules), etc. layout in Admin > Studio.

From Record View layout (for Sidecar modules) :

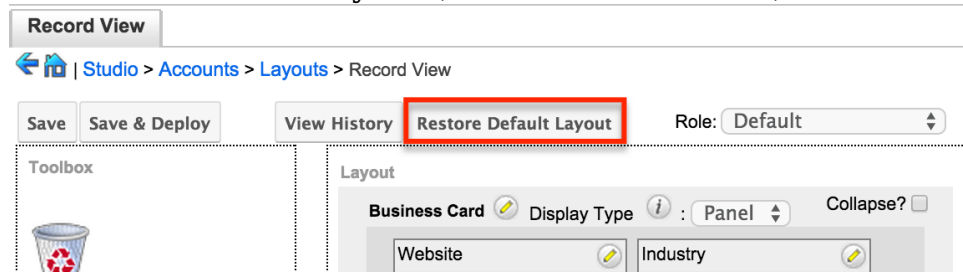

From Edit View layout (for Legacy modules) :

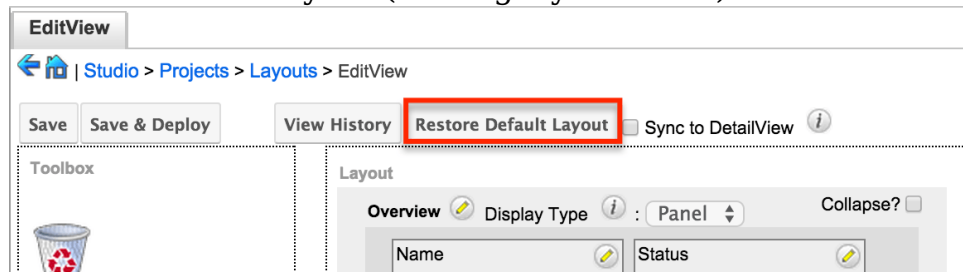

The default layout will load into the editor and you may make appropriate changes to the layout as you wish. Click "Save" to preserve your changes or "Save & Deploy" to preserve your changes and deploy immediately.

Note: When using role-specific record view layouts, the functionality of the Restore Default Layout button changes depending on which the Role dropdown's

selection. Please refer to the [Restoring Customized Role-Views to the Default Role-View Layout](#) section for more information.

Resetting Modules

Sugar comes with the ability to reset an entire module back to the default settings. You can also pick and choose which customizations you would like to remove. To reset a module, select the module from the Modules Panel and click "Reset Module" in the Main Panel.

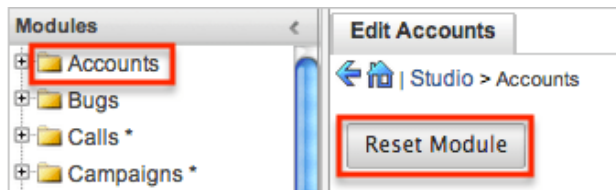

The next screen will give you the following options to remove specific customizations:

- **Clear Relationships** : Deletes all relationships added via Studio.
- **Remove Custom Fields** : Deletes all fields added via Studio.
- **Reset Layouts** : Resets the layouts back to the out-of-the-box configuration. You will need to click "Save & Deploy" on edit view and detail view layouts to be able to access the layouts.
- **Reset Labels** : Deletes the custom language files located in `./custom/modules/{Module Name}/language/` which sets the labels for the module.
- **Clear Extensions** : Deletes any customizations made to stock or custom fields and sets them back to the default. Deletes the module folder located in `./custom/Extension/modules/`.

Select the desired options and click "Reset" to execute the reset.

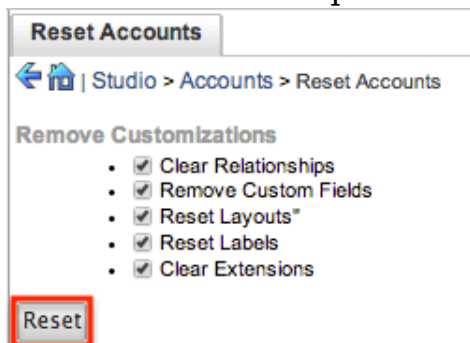

Exporting Customizations

Sugar allows you to export a module's customized layouts, fields, and field labels from one Sugar instance to import into another Sugar instance. To do this, you will need to package the customizations in Studio, export it to your local machine, and then upload it into another Sugar instance. The system applies the customizations to the appropriate layouts, fields, and field labels.

Note: Safari users will need to change the default browser setting to disable automatic unzipping of files to ensure that exported packages install properly in Sugar. Navigate to Safari > Preferences > General and uncheck "Open 'safe' files after downloading" to disable the setting.

Use the following steps to export your customizations via Studio:

1. From the Studio home page, select "Export Customizations" in the main panel.

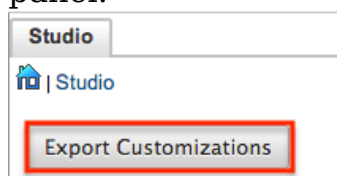

2. Enter appropriate values in the following fields. All required fields are marked with a red asterisk and must be completed prior to saving.

- **Package Name** : Enter the name of the package to be displayed during installation.
- **Author** : Enter the name of the author creating the package to be displayed during installation.
- **Description** : Enter a description of the export to be displayed during installation.
- Select at least one module to include in the customization export and click "Export".

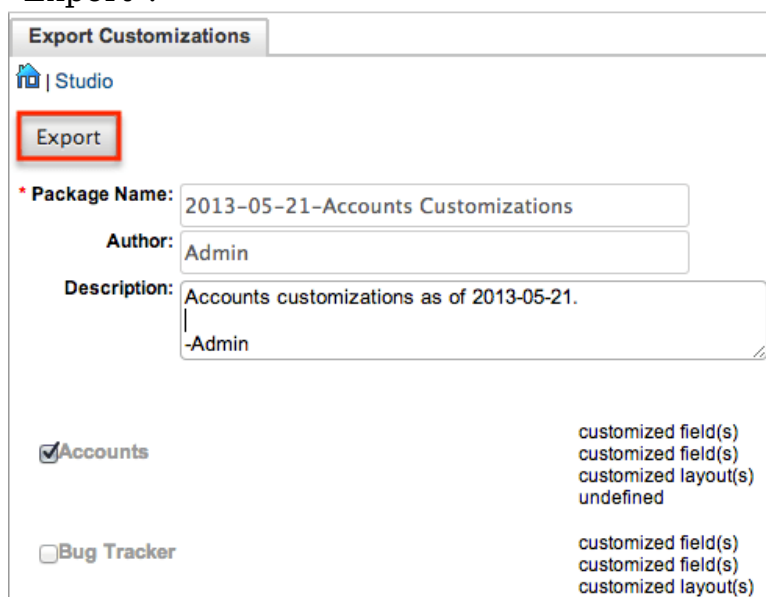
A screenshot of the 'Export Customizations' form in the Studio application. The title bar says 'Export Customizations'. Below it is a home icon and '| Studio'. A button labeled 'Export' is highlighted with a red box. The form contains the following fields:

- * Package Name:** 2013-05-21-Accounts Customizations
- Author:** Admin
- Description:** Accounts customizations as of 2013-05-21.
-Admin

Below the description field, there are two checkboxes for selecting modules to export:

- Accounts: customized field(s), customized field(s), customized layout(s), undefined
- Bug Tracker: customized field(s), customized field(s), customized layout(s)

-
- The customizations are saved to your computer in a zip file that can be loaded into a different instance of Sugar via the module loader. For more information regarding installing packages, please refer to the [Module Loader](#) documentation.

Exporting Role-Based Customizations

If you have created role-based [custom record views](#) or [custom dropdown lists](#), these role-based customizations will be included in your exported package. When installing the package on another Sugar instance, you will be given the opportunity to map role-based customizations from the package's roles to the destination instance's roles. Please refer to the [Module Loader](#) documentation for more information.

Last Modified: 2019-12-18 19:15:44

Module Builder

Overview

Module Builder enables administrators to create, deploy, and maintain custom modules in Sugar. Modules can be created in Module Builder and then deployed within your instance of Sugar or exported for additional development and deployment to other instances of Sugar. This is convenient for testing new modules and for distributing a module to many different instances. Please note that only users with administrator or developer access can create and manage custom modules via Admin > Module Builder. This documentation will cover how to use Module Builder as well as the various actions and options available from within Module Builder.

Navigation

Sugar's Module Builder is divided into three main sections which consist of the main panel, packages panel, and footer. You can easily create, access, and manage the custom modules via the main panel and Packages panel. The footer of Module Builder allows you to access different areas (e.g. Studio, Dropdown Editor) of the Developer Tools section by clicking the corresponding buttons at the bottom of the page.

Main Panel

The main panel in Module Builder is where you can create a new package, access existing packages, deploy a package, etc. As you create and configure the module(s) within the package, the various sections (e.g. layouts, fields, etc.) you access will open inside tabs on the main panel. Additional tabs that open up can be closed by clicking the "X" within the tab.

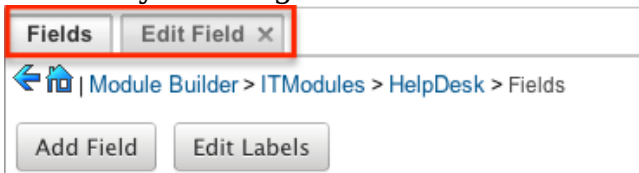

The main panel also displays the breadcrumbs bar showing where in Module Builder you currently are. You can navigate to a specific section by clicking the link within the breadcrumb bar.

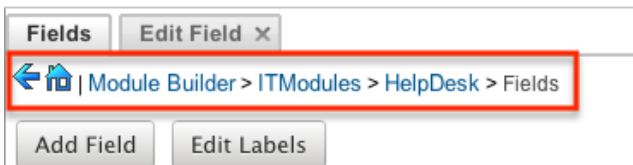

To go back to the previous page you were viewing, click the Left arrow on the breadcrumbs bar. Clicking the Home icon will navigate you back to the Developer Tools home page.

Packages Panel

The Packages panel is located to the left of the main panel and displays a list of existing packages and associated custom modules that are accessible via Module Builder. The custom modules are grouped under a package and the fields, layouts, subpanels, etc. specific to each module appear when you expand out the tree for the module.

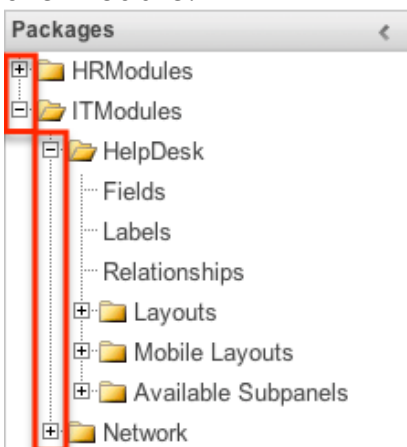

Select an item in the Packages panel to load it into the main panel. Please note that if you do not see the Packages panel, it may be collapsed. Simply locate the

gray bar to the left of the main panel and click the Right arrow to expand the Packages panel.

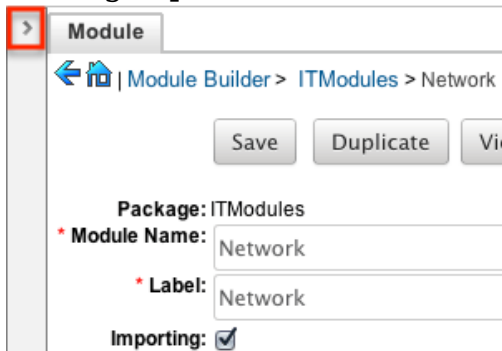

Footer

The footer is located on the bottom left of Module Builder and displays buttons which enable you to navigate to the different areas (Studio, Dropdown Editor, etc.) of Developer Tools.

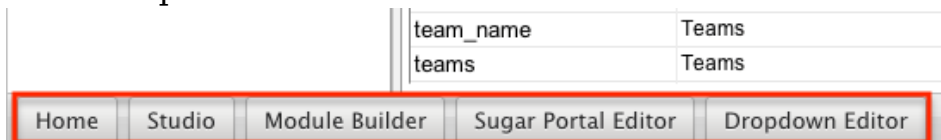

The options in the footer allow you to navigate to the following locations:

Menu Item	Description
Home	Navigates to the home page of Developer Tools
Studio	Navigates to the home page of Studio
Module Builder	Opens Module Builder to create and manage custom modules
Sugar Portal Editor	Opens the Sugar Portal Editor to configure the Portal
Dropdown Editor	Opens the Dropdown Editor to create and edit dropdown lists

Packages

Packages in Module Builder allow you to create and house multiple modules of different types. Please note that a package must first be created in order to create a custom module via Module Builder. While packages can be useful to group similar or dependent modules together to ensure they are deployed together, it is

generally recommended that a separate package be created for each module. This can help prevent potential issues down the road since if you ever need to uninstall a module and it is part of a larger package, then all modules in that package must be uninstalled. Keeping modules isolated to their own package allows greater flexibility in the future if a module is no longer needed.

Creating Packages

Use the following steps to create a new package via Module Builder:

1. Navigate to the Module Builder's main panel and click "New Package".

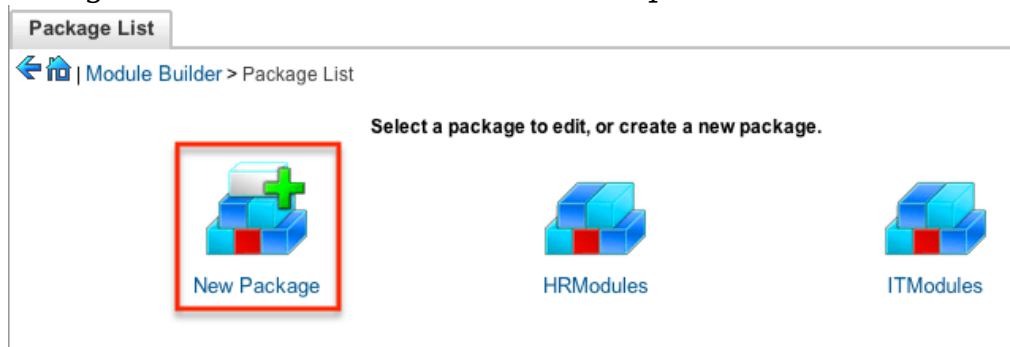

2. Enter appropriate values for the following fields:
 - **Package Name** : The name or designation of the package. The package name is what displays in the Packages panel and in Module Loader when installing packages.
 - **Author** : The author who is creating the package. The author displays in Module Loader when installing packages.
 - **Key** : The key is an alphanumeric text to distinguish modules with similar names. The system will prefix all class names, directories, and table names with this key.
 - **Description** : A description or other information about the package.
 - **Readme** : Click "Readme" to display an open text box where you can enter additional information about the package or modules contained in the package.
 - **Note**: All required fields are marked with a red asterisk and must be completed prior to saving.
3. Once the necessary information is entered, click "Save".

Package

Module Builder > New Package

Save

* Package Name: FinModules

Author: Admin

* Key: FIN

Description:

Readme

Deploying Packages

Once the package is created and saved, you can create custom modules by clicking the New Module icon. Please note that the package must contain at least one module in order to properly publish and deploy the package, as well as export the customizations. There are various options (e.g. deploy, publish, export, etc.) available when viewing the package which allow you to perform various actions.

Package

Module Builder > FinModules

Save Duplicate Deploy Publish Export Delete

Last Modified: 09/26/2013 11:17am

* Package Name: FinModules

Author: Admin

* Key: Fin

Description:

Readme

Modules:

New Module

The Package options allow you to perform the following operations:

Action	Description
Save	Click "Save" to preserve any changes made to the Package details (Package Name, Author, etc.).
Deploy	Installs the package into the current instance. Any modules in the package

	<p>will be created or updated in the current instance.</p> <p>Note: Do not re-deploy a package once deployed from Module Builder as any workflows, code-level customizations, or changes made through Studio for the custom modules will be lost. It is recommended that module packages be deleted from Module Builder after a successful deploy to avoid an accidental re-deploy. Please use Studio to perform any additional configurations to your module once deployed.</p>
Publish	<p>Saves the package into an installable zip file containing all customizations. Upload the file via Module Loader to install the package into a different instance.</p> <p>Note: Packages developed on Sugar Serve can only be installed on instances running the same version of Sugar Serve.</p>
Export	<p>Saves the package into an importable zip file containing all customizations. Upload the file via Module Loader to view the package in Module Builder on a different instance where it can then be further developed and deployed.</p> <p>Note: Packages developed on Sugar Serve can only be installed on instances running the same version of Sugar Serve.</p>

Deleting Packages

If a package is invalid or should no longer appear in your organization's Sugar instance, it may be deleted from Module Builder. Please note that deleting a package will delete all files contained in the package, but will not remove the package from any instance where the package was deployed. For more information on how to uninstall a deployed package from an instance, please refer to the [Module Loader](#) documentation in the Administration guide.

Note: We recommend deleting packages from Module Builder after they have been deployed in a production instance to prevent it from accidentally being re-deployed. The only exception to this rule is in a development environment as you may want to continue working and testing until you are ready to move the module to your production environment.

Use the following steps to delete a package via Module Builder:

1. Select the desired package from either the Packages panel or from the main panel.

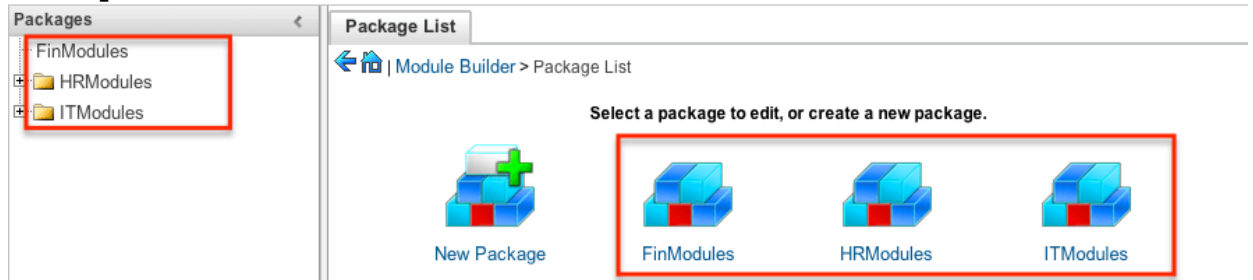

2. Click "Delete" to remove the package.

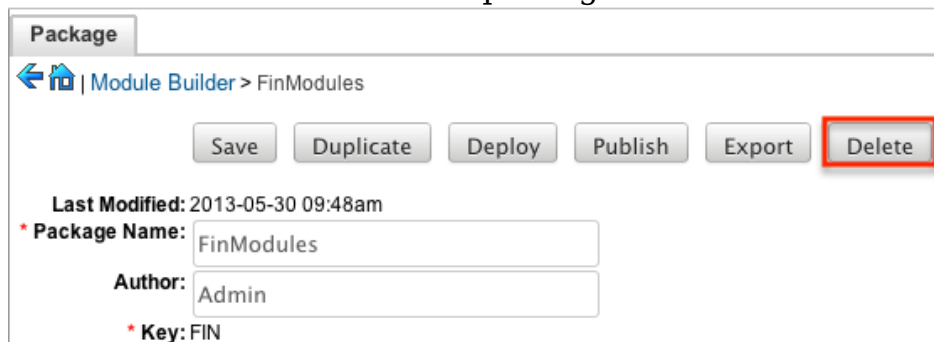

3. A pop-up message will display asking for confirmation. Click "Ok" to proceed.

Modules

Various types of modules can be created and configured within the package in Module Builder. Although multiple custom modules can be created in a package, it is generally recommended that only one module be created per package. This will help prevent potential issues down the road and allow greater flexibility in the future if a module is no longer needed.

Note: Activity streams are not available for custom modules.

Module Types

Module Builder comes with a few predefined module templates for creating

modules. Select the module type that best fits your organization's use of the new module and then customize the module to further fit your needs.

The following module types are available by default in Module Builder:

Type	Description
Basic	Generic module with only the most basic fields defined by default. All other module types build on top of the basic module type.
Company	Contains fields designed for company, account, or organization type records. Includes billing and shipping addresses, email address, phone numbers, industry, website, and more.
File	Contains fields designed for file upload or document records. Includes category, expiration date, status, filename, and more.
Issue	Contains fields designed for bug, issue, or case record types. Includes issue number, status, priority, work log, and more.
Person	Contains fields designed for people, contacts, or lead records. Includes first and last name, primary and alternate addresses, email addresses, phone numbers, and more.
Sale	Contains fields designed for sales, transactions, or opportunities. Includes, amount, currency, probability, sales stage, and more.

Module Options

When creating modules in Module Builder, the following options are available to complete when setting it up:

- **Module Name** : The name (e.g. HelpDesk) or designation of the module. The module name is what displays in the Packages Panel as well as in Studio after deploying.
- **Plural Label** : The plural label (e.g. HelpDesks) for the module name. The

label is what displays when using the module within Sugar.

- **Singular Label** : The singular label (e.g. HelpDesk) for the module name. The label is what displays when using the module within Sugar.
- **Importing** : Select this option to enable importing for the module.
- **Team Security** : Select this option to enable team security for the module. If this option is unchecked, records in this module will not be assigned to a team and will be restricted by roles only. For more information on teams and roles, please refer to the [Team Management](#) and [Role Management](#) documentation in the Administration guide.
- **Navigation Tab** : Select this option to add the module and module actions to the navigation bar.
- **Type** : Select the module type to use as a template when building the module. Each module type includes a list of stock fields by default which can be added and removed in the layout as necessary. Please note that the module type can only be selected when initially creating the module. For more information regarding the module types, please refer to the [Module Types](#) section of this page.

Creating Modules

While you have the option to create multiple types of modules within a package, it is generally recommended that only one module be created per package. Doing so will help prevent potential issues down the road and allow greater flexibility in the future if a module is no longer needed.

Creating Modules Via Package

One of the most common methods of module creation is via the New Module option in the package. When the New Module icon is selected, it opens up the New Module screen which allows you to enter in the module's details (e.g. name, label, etc.) as well as select the module type you wish to use as a template.

Use the following steps to create a custom module in the package:

1. Select a package from the Packages Panel to create a new module.

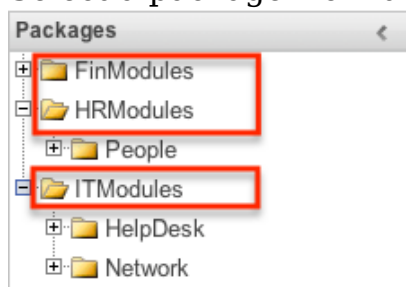

2. In the main panel select "New Module".

Package

Module Builder > HRModules

Save Duplicate Deploy Publish Export Delete

Last Modified: 2013-05-30 03:45pm

* Package Name: HRModules

Author: Admin

* Key: HR

Description:

Readme

Modules:

New Module People

3. Enter the appropriate values for the [Module options](#). All required fields are marked with a red asterisk and must be completed prior to saving.
4. Select a module type (e.g. file) to use as a template when configuring your module.
5. Once the necessary information is entered, click "Save".

Module

Module Builder > HRModules > New Module

Save

Package: HRModules

* Module Name: Resumes

* Label: Resumes

Importing:

Team Security:

Navigation Tab:

* Type:

basic company file issue person sale

Creating Modules Via Duplication

You can also create a new module by duplicating an existing module within a package. The duplicate option is useful if the module you are creating has similar information or structure to an existing module.

Use the following steps to create a module by duplicating an existing module:

1. Select a package from the Packages panel to create a new module.

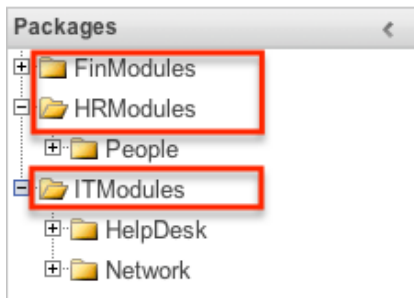

2. In the main panel, select a module to duplicate.

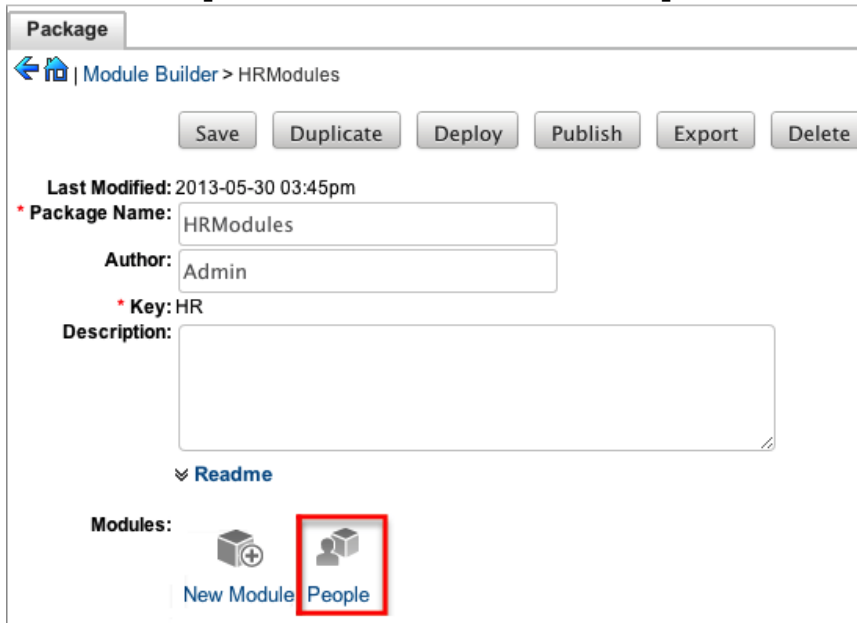

3. Click "Duplicate" to create a copy of the module.

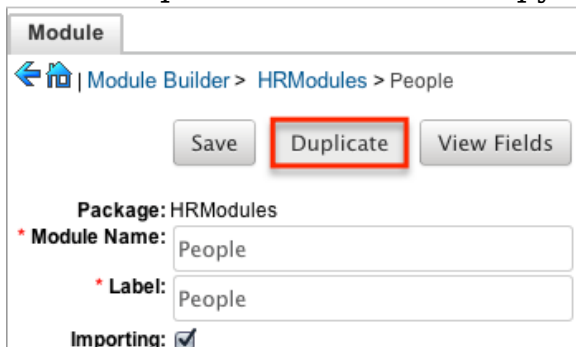

4. The selected module is duplicated to a new module with a "1" appended at the end of the module name. Update the necessary fields, then click "Save".

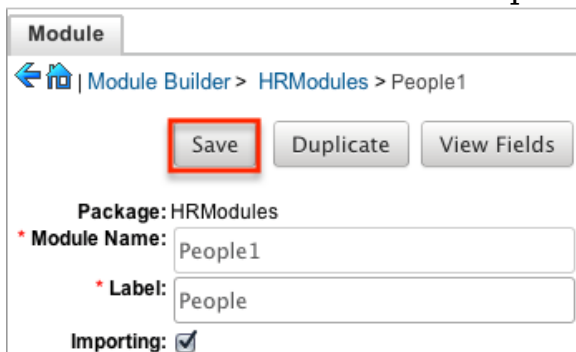

Modifying Modules

The associated fields, labels, layouts, subpanels, etc. for each module can be modified within each package. Click the plus sign (+) preceding the module name to expand the module and view the associated items (e.g. Layouts, Fields, etc.). Selecting the module from the Packages panel will load the view into the main panel. You can modify the [Module options](#) for the selected module via this page.

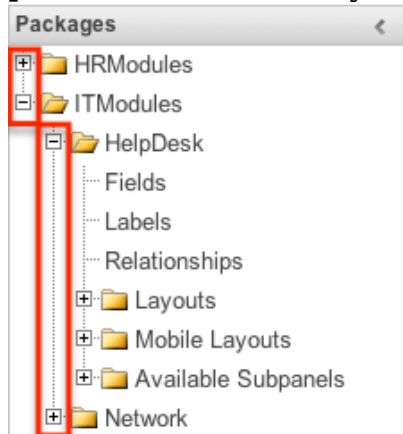

Modifying Labels

Labels are used throughout Sugar for items like buttons, field headers, subpanel titles, error messages, and more. To modify the labels for a module, select "Labels" from the Packages panel under the desired module.

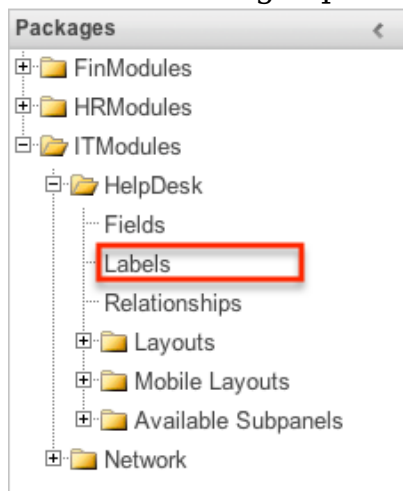

The Labels tab will open up in the main panel where you can change the names for specific labels associated to the module. Please note that you can also define the primary language to use per the language packs currently installed in Sugar when changing the labels. Select the desired language from the dropdown to view and modify the labels according to that language.

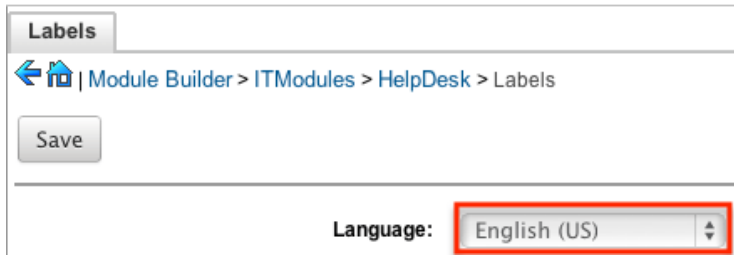

Modify the labels for the selected language and click "Save" to preserve your changes.



Fields

The Fields section in Module Builder allows administrators to create new fields as well as change properties on existing fields within a module. To access the Fields section in Module Builder, select "Fields" from the Packages panel under the desired module and the view will open up in the main panel to the right.

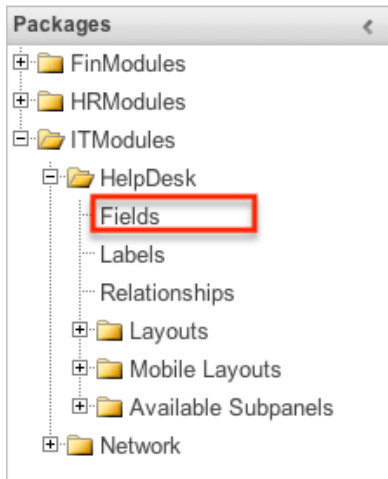

Field Types

The Fields section for each module contains a number of stock fields which come out-of-the-box with Sugar. Please note that each data type has various options and properties available to configure.

The following data types are available to be added to modules in Module Builder:

Data Type	Description
Address	Creates fields for street, city, postal code, state, and country. Note: Custom address fields cannot be grouped together like the stock address fields.
Checkbox	Creates a checkbox for data fields with a Yes/No action.
Currency	Creates a field to enter a currency value. The system automatically creates a dropdown of the currency type if the field does not already exist in that module.
Date	Creates a field to enter a date. Includes a button for a calendar popup.
DateTime	Creates a field to enter the date and time. Includes a button for a calendar popup as well as dropdowns for the time.
Decimal	Creates a field to hold a number rounded to a specified decimal precision. Sugar stores the exact representation of the number in the database (e.g. For a precision of 2: 1.236 is stored as 1.24).
DropDown	Creates a field that you can associate with a dropdown list of values.
Encrypt	Creates a field for sensitive information, such as social security numbers, whose value is to be encrypted in the Sugar database. The value is encrypted in the database but is visible in the user interface to users.
Float	Creates a field to hold a number rounded to a specified decimal precision. Sugar stores the value differently based on the database platform Sugar is running on.
HTML	Creates static HTML-formatted text to display in record views.
IFrame	Creates a field to store or generate a URL to display an iFrame in record

	views.
Image	Creates an image field to upload an image to display on a record.
Integer	Creates a field to specify positive or negative numbers with no decimal places.
MultiSelect	Creates a dropdown list of values where multiple values can be selected at once.
Flex Relate	Creates a dropdown list from which you can relate a single record from a variety of modules. Only one Flex Relate field is allowed per module. If the module already has a Flex Relate field, this option does not display in the Data Type dropdown list.
Phone	Creates a field to enter a phone number.
Radio	Creates a radio button for a user to select one value from a dropdown list.
Relate	Creates a field to associate a record with another module's record as a one-way relationship. You can add multiple Relate fields to a module. Note: Relate fields and custom relationships are independent of each other. Changes made to either one are not reflected in the other. Relate fields can be added to a report, but any data on the related record cannot be accessed in the report. To access related record data in a report you will need to create a custom relationship.
TextArea	Creates an open text area field for multiple lines of text.
TextField	Creates a field for a single line of text.
URL	Creates a field to store or generate a URL and display as a link.

Field Options

Fields provide ways to store different data types in Sugar. While many fields come

out-of-the-box with Sugar by default, there can be instances where your organization needs to store additional data.

When creating or modifying fields via Module Builder, there are some properties that exist across all field types, and there are some that are unique to only a few types.

The following field properties and options are available in Sugar:

- **Audit** : Select this checkbox to audit the field for changes made in Sugar.
 - Users can view the changes made to audited fields via the View Change Log option in the module's record view (for Sidecar modules).
 - **Note:** The Audit option is available for all data type fields.
- **Boost value** : Enter a boost value for the field to enhance the relevancy of the field for full text search.
 - The default boost value is 1.0 which indicates a neutral boost. To apply a positive boost, set the boost value higher than 1. To apply a negative boost, use values lower than 1. For example, a value of 1.35 will positively boost a field by 135%. But using a value of 0.60 will apply a negative boost.
 - **Note:** It is not necessary to perform a full system index when boost values are changed for fields.
- **Border** : Select this checkbox to add a border around the image for this field.
 - **Note:** The Border option is only available for Image data type fields.
- **Calculated Value** : Select this checkbox to designate this field as a calculated field.
 - This opens up the Formula option and disables the Default Value and Importable options. For more information regarding entering a formula for a calculated value, please refer to the Formula option listed in this section.

Calculated Value: 

Formula:

- The result of the formula will be entered into the field for any new or modified records. When selecting this option, the field value cannot be modified by users.
- **Note:** The Calculated Value option is only available for the following data type fields:

Checkbox	Currency
Date	Datetime
Decimal	Encrypt
Float	Integer

Phone	TextArea
TextField	

- **Columns** : Enter the number of columns to specify the width of a TextArea data type field.
 - **Note:** The Columns option is only available for TextArea data type fields.
- **Comment Text** : Enter a comment or description about the field. The comment text is only viewable via Module Builder and Studio.
 - **Note:** The Comment Text option is available for all data type fields except Flex Relate.
- **Default Value** : Specify or select a default value for this field when a record is created. Default values for the record are populated by default on the record view layout, but can be modified by users.
 - **Note:** The Default Value option is available for all data type fields except HTML, Image, Flex Relate, and Relate.
- **Dependent** : Select this option to designate this field as being dependent on a formula or a parent dropdown.
 - For DropDown data type fields you can select "Parent Dropdown" or "Formula" for the dependency.

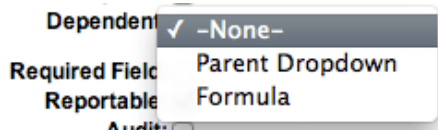

- Selecting "Parent Dropdown" will open the Parent Dropdown option as shown below. Selecting "Formula" will open the Visible If option to create a dependency formula. For other field data types (e.g. Date), select the Dependent checkbox to open the Visible If option. For more information regarding entering a formula to make a dependent field visible, please refer to the Visible If option listed in this section.

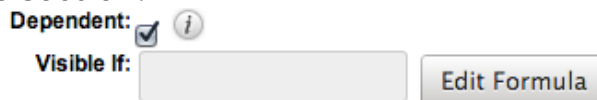

- **Note:** The Dependent option is available for all data type fields except Address.
- **Disable Format** : Select this checkbox to disable number formatting such as the thousands separator.
 - **Note:** The Disable Format option is only available for Integer data type fields.
- **Display Label** : Enter a value to display as the field label and header in layouts. Normally defaults to the Field name entered when creating the field.
 - This value is also modifiable in the packages panel under [Labels](#).
 - **Note:** The Display Label option is available for all data type fields except Flex Relate. Flex Relate uses the Label Value option.

-
- **Drop Down List** : Select a list of values to associate to the field.

Drop Down List: 

- Only values in the chosen list will be available for selection in the field. Click "Edit" to change the values for the currently selected list, or click "Add" to create a new list.
 - **Note:** The Drop Down List option is only available for the DropDown, MultiSelect, and Radio data type fields. For more information on editing dropdown values via the Dropdown Editor, please refer to the [Editing Dropdown Lists](#) section of the Developer Tools documentation.
- **Duplicate Merge** : Select one of the following options to determine the field's functionality when records are being merged:
 - **Disabled** : Selected by default. The field will not appear in the Merge Duplicates feature and will not be available to use for the filter conditions in the Find Duplicates feature.
 - **Enabled** : The field will appear in the Merge Duplicates feature, but will not be available to use for the filter conditions in the Find Duplicates feature.
 - **In Filter** : The field will appear in the Merge Duplicates feature, and will also be available in the Find Duplicates feature.
 - **Default Selected Filter** : The field will be used for a filter condition by default in the Find Duplicates page, and will also appear in the Merge Duplicates feature.
 - **Filter Only** : The field will not appear in the Merge Duplicates feature, but will be available in the Find Duplicates feature.
 - **Note:** The Duplicate Merge option is available for all data type fields except Image.
 - **Field Name** : Enter the name of the field being created. Once a field has been created, the field name cannot be changed.
 - Field names can contain only alphanumeric characters as well as the underscore character.
 - **Note:** The Field Name option is required for all data type fields.
 - **Full Text Searchable** : Specify whether or not the field should affect Global Search results.
 - **Disabled** : Select "Disabled" if you do not want this field to be captured when the database is indexed for searches. Search indices collect the values of searchable fields for evaluation by the Global Search.
 - **Searchable** : Select "Searchable" to include this field's value in search indexes.
 - Selecting "Searchable" will reveal the Boost value field, which allows you to set a relevance weight for searches. When a user's search query matches the value of a field with a higher boost level, the record will appear higher in the

search results. For more information regarding boost values in Full Text Search, please refer to the [Search](#) documentation in the Application guide.

- **Note:** The Full Text Searchable option is only available for the following data type fields:

Phone	TextArea
TextField	URL

- **Formula** : Contains the current formula to return a calculated value.
 - Click "Edit Formula" to launch the formula builder and change the formula. For more information on how to build a formula using the formula builder, please refer to the [Using Sugar Logic](#) section of this page.

Calculated Value: ⓘ

Formula:

- **Note:** The Formula option is only available when the Calculated Value option is selected.
- **Generate URL** : Select this checkbox to allow variables from the current module to be placed into the Default Value option for creating dynamic URLs.

Generate URL:

Default Value:

- This is useful for providing links or iFrames to internal systems such as an ERP or to external systems such as Google Maps.
- Select the desired field to add from the dropdown and click "Insert Field" to add the field to the Default Value. When selecting this option, the field value cannot be modified by users.
- **Note:** The Generate URL option is only available for IFrame and URL data type fields.
- **Height** : Enter the number of pixels to vertically scale the image for this field. Enter only the Width or Height options to retain the aspect ratio of the image.
 - **Note:** The Height option is only available for Image data type fields.
- **Help Text** : Enter in basic instructions for populating this field. The text entered here will display when users hover their mouse on the field in record view.
 - **Note:** The Help Text option is available for all data type fields.
- **HTML** : Enter in static rich text with formatting or HTML code to display on a record. For more information on how to use the text editor please refer to the [TinyMCE](#) section of the User Interface documentation in the Application guide.

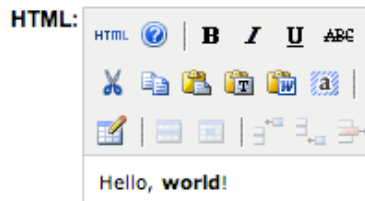

- **Note:** The HTML option is only available for HTML data type fields.
- **IFrame Height** : Enter the number of pixels for the height of the IFrame field. The width of the IFrame field is always the width of the field container.
 - **Note:** The IFrame Height option is only available for IFrame data type fields.
- **Importable** : Select one of the following options to determine the field's functionality when records are being imported:
 - **Yes** : The field can be included in an import operation.
 - **No** : The field cannot be included in an import.
 - **Required** : A value for the field must be provided in any import.
- **Label Value** : Enter a value to display as the field label and header in layouts. This value is also modifiable in the packages panel under [Labels](#). Defaults to "Flex Relate".
 - **Note:** The Label Value option is only available for Flex Relate data type fields.
- **Mass Update** : Select this checkbox to add this field as an option to mass update.
 - **Note:** The Mass Update option is only available for the following data type fields:

Date	Datetime
DropDown	MultiSelect
Radio	

- **Max Size** : Enter the maximum amount of characters allowed for this field. Defaults to 255.
 - **Note:** The Max Size option is only available for the following data type fields:

Address	Decimal
Float	IFrame
Integer	Phone
URL	TextField

- **Max Value** : Enter the highest value allowable for this field. If a user enters a higher value in the field than the specified value, a notification will appear upon save informing them of the set maximum value.

-
- **Note:** The Max Value option is only available for Integer data type fields.
 - **Min Value :** Enter the lowest value allowable for this field. If a user enters a value in the field that is lower than the specified value, a notification will appear upon save informing them of the set minimum value.
 - **Note:** The Min Value option is only available for Integer data type fields.
 - **Module :** Select a module from the dropdown to relate to the current module.
 - A module can relate back to itself, a good example of this would be a relate field on Contacts to relate back to Contacts for a referred by field. This will allow users to select which contact record referred a different contact. The chosen module cannot be modified once the field is created.

Module:

- **Note:** The Module option is only available for Relate data type fields.
- **Open Link In :** Select one of the following options to determine how a URL will open:
 - **New Window :** Opens the URL in a new Tab or Window depending on your browser and settings.
 - **Same Window :** Opens the URL in the same window as the record you are currently browsing.
 - **Note:** The Open Link In option is only available for URL data type fields.
- **Parent Dropdown :** Select an option from the dropdown to specify the parent that controls the visibility of this dropdown field.
 - The Parent Dropdown option is populated with the other dropdown data type fields in the current module.

Dependent:

Parent Dropdown:

- **Note:** The Parent Dropdown option is only available when the Dependent option has "Parent Dropdown" selected.
- Click "Edit Visibility" to specify which options are available from the current dropdown for each value of the parent dropdown. In the Visibility Editor window, drag values from the current dropdown list to the value sections of the parent dropdown.

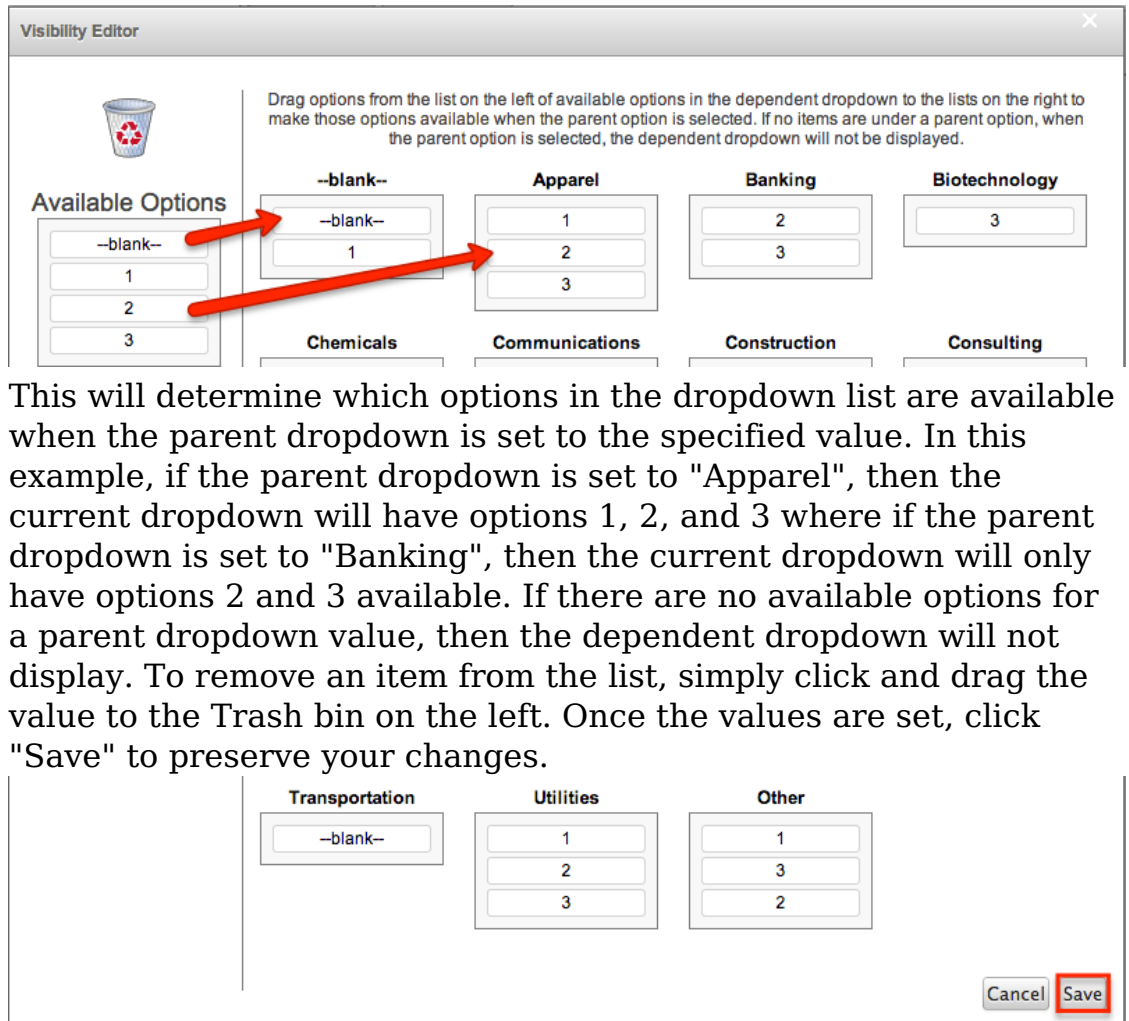

- This will determine which options in the dropdown list are available when the parent dropdown is set to the specified value. In this example, if the parent dropdown is set to "Apparel", then the current dropdown will have options 1, 2, and 3 where if the parent dropdown is set to "Banking", then the current dropdown will only have options 2 and 3 available. If there are no available options for a parent dropdown value, then the dependent dropdown will not display. To remove an item from the list, simply click and drag the value to the Trash bin on the left. Once the values are set, click "Save" to preserve your changes.

- **Precision** : Enter a number to specify the number of digits to the right of the decimal point the value should be stored as in Sugar.
 - **Note:** The Precision option is only available for Decimal and Float data type fields.
- **Reportable** : Select this checkbox to allow the field to be used in reports.
 - **Note:** The Reportable option is available for all data type fields except Encrypt, Flex Relate, HTML, IFrame, and Image.
- **Required Field** : Select this checkbox to mark the field as required in Sugar. The user will be required to enter a value for the field before saving the record.
 - **Note:** The Required option is available for all data type fields except Checkbox and HTML.
- **Rows** : Enter the number of rows to specify the height of a TextArea data type field.
 - **Note:** The Rows option is only available for TextArea data type fields.
- **System Label** : Enter the system value for storing the label of the field. This is defaulted to the name of the field preceded by "LBL". Any lowercase characters entered will be converted to an uppercase upon saving. Once the field has been created, the system label cannot be changed.

- It is recommended that administrators avoid naming fields with the same system label in order to prevent the same label and header values from existing in the system.
 - **Note:** The System Label option is available for all data type fields.
 - **Visible If** : Contains the current formula to determine if a field is visible on the layout or not.
 - Click "Edit Formula" to launch the formula builder to change the formula.
-
- The formula must result in a Boolean (true/false) response. For more information on how to build a formula using the formula builder, please refer to the [Using Sugar Logic](#) section of this page.
 - **Note:** The Visible If option is only available when the Dependent option is checked or "Formula" is selected from the dropdown.
- **Width** : Enter the number of pixels to horizontally scale the image for this field. Enter only the Width or Height options to retain the aspect ratio of the image.
 - **Note:** The Width option is only available for Image data type fields.

Creating Fields

Use the following steps to create a new field via Module Builder:

1. Expand out the tree under the desired module in the Packages panel and select "Fields".

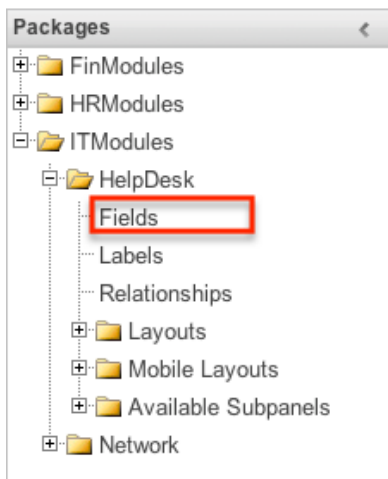

2. In the main panel click "Add Field".

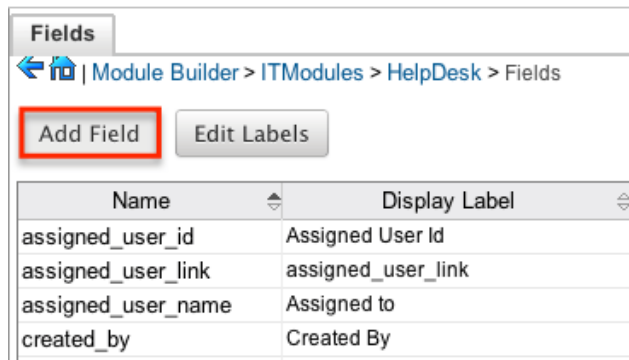

3. Enter appropriate values for the [Field options](#). Please note that Field Name is required.
4. Once the necessary information is entered, click "Save".

Edit Fields | **Edit Field** ×

Save | Cancel | Delete | Clone

Data Type: DropDown

Field Name:

Display Label:

System Label:

Help Text:

Comment Text:

Drop Down List:

Default Value:

Mass Update:

Dependent:

Required Field:

5. Once a field is created it must be placed on the record view layout in order for users to enter data into that field. For more information on editing layouts, please refer to the [Editing Layouts](#) section of this page.

Editing Fields

Use the following steps to edit an existing field via Module Builder:

1. Expand out the tree under the desired module in the Packages panel and select "Fields".

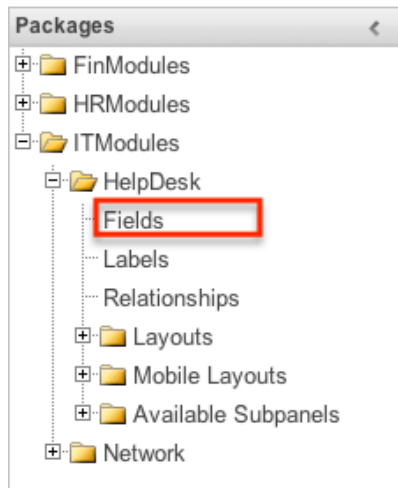

2. In the main panel, select a field to edit. Sorting the fields by the column header will help in locating the field faster.
 - **Note:** Fields created via Module Builder will display an asterisk (*) in front of their name.

Fields

Module Builder > ITModules > HelpDesk > Fields

Add Field Edit Labels

Name	Display Label	Type
assigned_user_id	Assigned User Id	Relate
assigned_user_link	assigned_user_link	Link
assigned_user_name	Assigned to	Relate
created_by	Created By	Assigned_user_name
created_by_link	Created by User	Link
created_by_name	Created By	Relate
date_entered	Date Created	Datetime
date_modified	Date Modified	Datetime
deleted	Deleted	Checkbox
* department	department	TextField
description	Description	TextArea
id	ID	Id
itmp_helpdesk_number	Number	Integer
modified_by_name	Modified By Name	Relate
modified_user_id	Modified By	Assigned_user_name

3. Update the necessary [Field options](#) and click "Save" once complete.

Edit Fields Edit Field ×

Save Cancel Clone

Data Type: TextArea
Field Name: description
Display Label: Description:
System Label: LBL_DESCRIPTION
Help Text: Enter in a detailed Des
Comment Text: Case details.
Rows: 6
Columns: 80

Deleting Fields

Use the following steps to delete an existing field via Module Builder:

1. Expand out the tree under the desired module in the Packages panel and select "Fields".

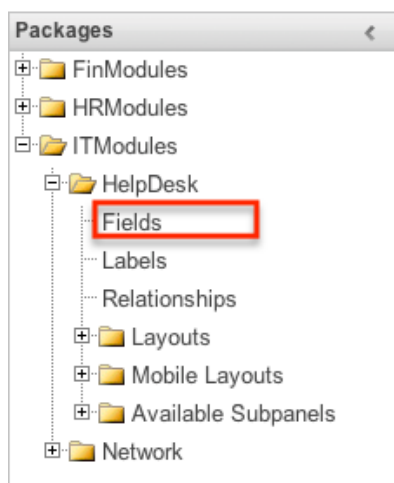

2. In the main panel, select a field to delete. Sorting the fields by the column header will help in locating the field faster.
 - Fields created via Module Builder will display an asterisk in front of their name.
 - **Note:** Fields added via the module type template cannot be deleted.

Fields

Module Builder > ITModules > HelpDesk > Fields

Add Field Edit Labels

Name	Display Label	Type
assigned_user_id	Assigned User Id	Relate
assigned_user_link	assigned_user_link	Link
assigned_user_name	Assigned to	Relate
created_by	Created By	Assigned_user_name
created_by_link	Created by User	Link
created_by_name	Created By	Relate
date_entered	Date Created	Datetime
date_modified	Date Modified	Datetime
deleted	Deleted	Checkbox
* department	department	TextField
description	Description	TextArea
id	ID	Id
itmp_helpdesk_number	Number	Integer
modified_by_name	Modified By Name	Relate
modified_user id	Modified By	Assigned_user_name

3. Select "Delete" to remove the field.

Edit Fields Edit Field x

Save Cancel Delete Clone

Data Type: DropDown
 Field Name: support_level_c
 Display Label: Support Level
 System Label: LBL_SUPPORT_LEVEL
 Help Text: The current support le
 Comment Text:
 Drop Down List: support_level_list

Edit Add

4. A pop-up message will display asking for confirmation. Click "Ok" to proceed.

- Before deleting a field please verify and resolve the following issues:
 1. Field must be removed from any report filters or displays.
 2. Field must be removed from any workflows that filters or displays the field.
 3. Field must be removed from any dashlet that filters or displays the field.
 4. Field must be removed from any Sugar Logic formulas.
 5. Field must be removed from any email templates.
 6. Field must be removed from any saved searches.
5. The field will automatically be removed from any module layouts when deleted.

- **Note:** When deleting fields in a module and re-deploying the

package, the data related to the field in the database will not be removed.

Cloning Fields

Use the following steps to clone an existing field via Module Builder:

1. Expand out the tree under the desired module in the Packages panel and select "Fields".

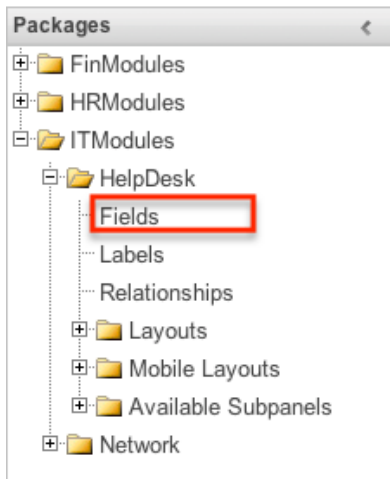

2. In the main panel, select a field to delete. Sorting the fields by the column header will help in locating the field faster.
 - **Note:** Fields created via Module Builder will display an asterisk (*) in front of their names.

Name	Display Label	Type
assigned_user_id	Assigned User Id	Relate
assigned_user_link	assigned_user_link	Link
assigned_user_name	Assigned to	Relate
created_by	Created By	Assigned_user_name
created_by_link	Created by User	Link
created_by_name	Created By	Relate
date_entered	Date Created	Datetime
date_modified	Date Modified	Datetime
deleted	Deleted	Checkbox
* department	department	TextField
description	Description	TextArea
id	ID	Id
itmp_helpdesk_number	Number	Integer
modified_by_name	Modified By Name	Relate
modified_user_id	Modified By	Assigned_user_name

3. Select "Clone" to duplicate the field.
 - **Note:** Some non-standard stock fields (e.g. Name) do not have the

ability to clone.

The screenshot shows the 'Edit Fields' dialog box for a field named 'support_level_c'. The 'Clone' button is highlighted with a red box. The field is a DropDown type. The 'Display Label' is 'Support Level', the 'System Label' is 'LBL_SUPPORT_LEVEL', and the 'Help Text' is 'The current support le'. The 'Drop Down List' is set to 'support_level_list'.

4. Enter appropriate values for the [Field options](#).
5. Once the necessary information is entered, click "Save".

The screenshot shows the 'Edit Fields' dialog box for a field named 'secondary_support'. The 'Save' button is highlighted with a red box. The field is a DropDown type. The 'Display Label' is 'Secondary Support', the 'System Label' is 'LBL_SECONDARY_SUPF', and the 'Help Text' is 'The current support le'. The 'Drop Down List' is set to 'support_level_list'. There are also fields for 'Default Value' (Standard), 'Mass Update' (checked), 'Dependent' (-None-), and 'Required Field' (unchecked).

Relationships

Relationships define the links between different modules in Sugar and allow records between those modules to be related. Related records display in fields or subpanels on a module's detail page depending on the relationship type. When you create a new relationship between two modules, the system automatically creates the necessary subpanels, related fields, and metadata relationships. Relationships provide the added benefit in reports to allow access to a related records fields in addition to the base module's fields.

The relationships section in Module Builder allows administrators to create new relationships between custom and stock modules as well as change some properties on existing relationships. To access the relationship section in Module Builder, select "Relationships" from the Packages panel under the desired module.

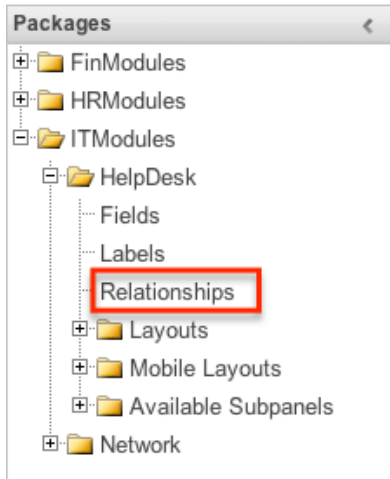

Note: Relationships created through Module Builder cannot be deleted in Studio after being deployed. Due to this, it is recommended that relationships be created in Studio after deploying the module instead of via Module Builder. As a best practice, never re-deploy the module from Module Builder as it will remove all customizations made to your module via Studio, code customizations, etc.

Relationship Types

Sugar contains a few different types of relationships you can create between modules. The relationship type will determine what fields or tables will be created in the database as well as what interface the user will see to manage the relationship.

The following relationship types are available in Module Builder:

- **One-to-One** : Records in the primary module and the related module are uniquely related to each other. For a one-to-one relationship between Accounts and Contacts, an account can be associated with only one contact and a contact can be associated with only one account. The relationship will show as a field in each module's record view where changing the relationship from either module will also change the value in the other module.

From the primary Accounts module:

Ac Avery Software Co ★ Follow

Website
<http://www.avery.com>

Member of

Assigned to
 Max Jensen

Contacts
[Donny Milliron](#)

From the related Contacts module:

Co Donny Milliron ★ Follow

Title
 VP Sales

Department

Account Name
[Avery Software Co](#)

Note: You can create a one way relationship between modules using relate fields. For more information regarding relate fields, please refer to the [Field Types](#) section of this page.

- **One-to-Many** : Records in the primary module can have relationships with many records in the related module. For a one-to-many relationship between Accounts and Contacts, an account can be associated with many contacts, but each contact can be associated with only one account. The record view of the primary module will display a subpanel for the related module, and the detail view of the related module will display a field containing a link to the related record.

From the primary Accounts module:

Co Contacts		
	Name	Account Name
★	Herb Glancy	NW Bridge Con...
★	Donny Milliron	Avery Software...

From the related Contacts module:

Donny Milliron
★ Follow

Title
VP Sales

Department

Account Name

Avery Software Co

Note: A one-to-many relationship is the same as a many-to-one relationship except the Primary and Related modules are reversed. Adding a custom one-to-many relationship to "Activities" will add custom relationships to calls, meetings, notes, tasks, and emails. This will also automatically add these subpanels to the record view.

- **Many-to-Many** : Records in both the primary module and the related module can have multiple records related in each module. For a many-to-many relationship between Accounts and Contacts, an account can be associated with many contacts, and a contact can be associated with many accounts. Both module's record view will display a subpanel for the opposite module.

From the primary Accounts module:

Contacts

	Name	Account Name
★	Herb Glancy	NW Bridge Con...
★	Donny Milliron	Avery Software...

From the related Contacts module:

Accounts

	Name	Phone
★	Avery Software Co	(320) 013-8679
★	NW Bridge Construction	(265) 634-6785

Note: Only modules with subpanels available can be on the "Many" side of a relationship. For example, the Product Catalog module lacks a subpanel; therefore, Product Catalog can only be selected on the "One" side of a relationship.

When you create a relationship for a module, the selected module is considered to be the primary module and the module that you relate it with is the related module.

You can also create a relationship between a module and itself. In this case, the relationship becomes a parent-child relationship. For example, you can create a

relationship from Accounts to Accounts in order to create sub-accounts within the primary account.

Creating Relationships

Use the following steps to create a new relationship via Module Builder:

1. Expand out the tree under the desired module in the Packages Panel, and select "Relationships".

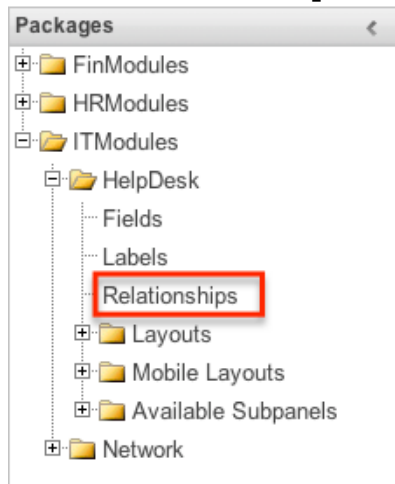

2. In the main panel, click "Add Relationship".

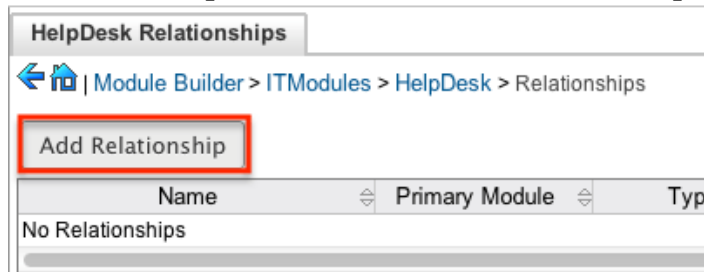

3. Enter appropriate values for the following options:
 - Type** : Select the type of relationship to create from the options in the [Relationship Types](#) section.
 - Module** : The Primary module is set to the module you are adding the relationship to. Select the Related module from the dropdown. The Primary and Related module can be the same in order to create a parent child relationship.
 - Label** : Enter a label to reference the Primary module or Related module's subpanels for this relationship. This option is only available for the "Many" side of a relationship.
 - Subpanel from** : Select a subpanel option to display the Primary or Related module's records in. This will determine the fields displayed in the subpanel. This option is only available for the "Many" side of a relationship.
4. Once the necessary information is entered, click "Save".

HelpDesk Relationships Edit Relationship x

Save Cancel

Primary Module		Type	Related Module	
Module:	Help Desk	Many to Many	Module:	Accounts
Label:	Help Desk		Label:	Accounts
Subpanel from Help Desk:	default		Subpanel from Accounts:	default

5. The required fields and subpanels are instantly created and saved in the package.

Editing Relationships

Use the following steps to edit a relationship via Module Builder:

1. Expand out the tree under the desired module in the Packages Panel, and select "Relationships".

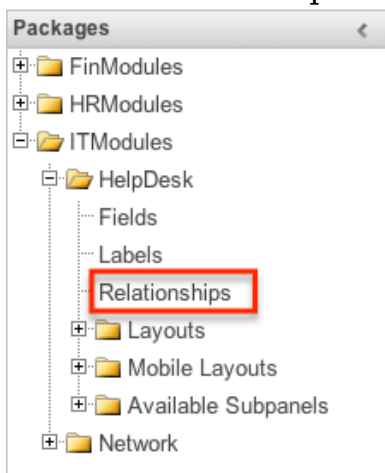

2. In the main panel, select a relationship to edit. Click the column headers to sort the grid by different columns to assist in locating the relationship.

HelpDesk Relationships

Module Builder > ITModules > HelpDesk > Relationships

Add Relationship

Name	Primary Module	Type	Related Module
itmp_helpdesk_accounts	Help Desk	Many to Many	Accounts
itmp_helpdesk_hr_people	Help Desk	One to Many	Person

3. The only editable field on a relationship is the Label field for naming the Primary or Related module subpanels. Please note that this option is only available for the "Many" side of a relationship.
4. Once the necessary information for the Label field is entered, click "Save".

HelpDesk Relationships Edit Relationship X

Save Cancel Delete

Name: itmp_helpdesk_hr_people

Primary Module	Type	Related Module
Module: Help Desk	One to Many	Module: Person
		Label: Employee
		Subpanel from Person: default

Deleting Relationships

Use the following steps to delete a relationship via Module Builder:

1. Expand out the tree under the desired module in the Packages panel and select "Relationships".

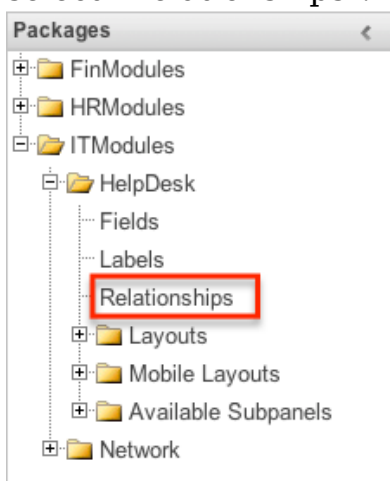

2. Select a relationship to delete in the main panel. Click the column headers to sort the grid by different columns to assist in locating the relationship.

HelpDesk Relationships

Module Builder > ITModules > HelpDesk > Relationships

Add Relationship

Name	Primary Module	Type	Related Module
itmp_helpdesk_accounts	Help Desk	Many to Many	Accounts
itmp_helpdesk_hr_people	Help Desk	One to Many	Person

3. Click "Delete" to remove the relationship.

HelpDesk Relationships Edit Relationship X

Save Cancel Delete

Name: itmp_helpdesk_hr_people

Primary Module	Type	Related Module
Module: Help Desk	One to Many	Module: Person
		Label: Employee
		Subpanel from Person: default

4. A pop-up message will display asking for confirmation. Click "Yes" to proceed.

Alert X

Are you sure you wish to delete this relationship?
 Note: This operation may not complete for several minutes.

Do Not Remove Tables

Yes No

Note: If you wish to retain the data and table structure that currently exists for the relationship, select the "Do Not Remove Tables" option. Leaving the "Do Not Remove Tables" unchecked will delete the relationship data and remove the tables for the relationship from the database when the package is installed.

Before deleting a relationship please verify and resolve the following issues:

- Relationship must be removed from any report filters or displays.
- Relationship must be removed from any workflows that filters or displays fields from the relationship.
- Relationship must be removed from any Sugar Logic formulas referencing the relationship.

Layouts

Layouts are used to represent many screens in Sugar. The layouts section in Module Builder allows administrators to add fields and configure layouts. To access the layouts section, expand "Layouts" from the packages panel under the desired module. The available layouts for the selected module will appear below.

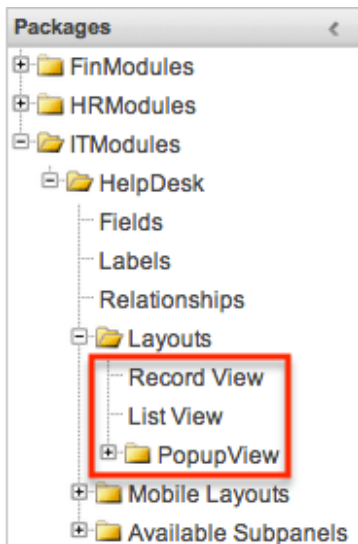

Layout Types

Sugar comes with different types of layouts to represent different sections of Sugar. Please note that not all layouts are available in every module.

The following layouts are available to configure in Module Builder:

- **Record View** : Record view layout is used to modify, create, or view a record within the specified module. Please note that this layout is specific to modules using the Sidecar user interface.
- **List View** : List view layout is used to view multiple records within the specified module and displays all results meeting the current search criteria.
- **Popup List View** : Popup list view layout is used to view multiple records via a popup window used to locate and select records in the specified module.

For Sidecar modules:

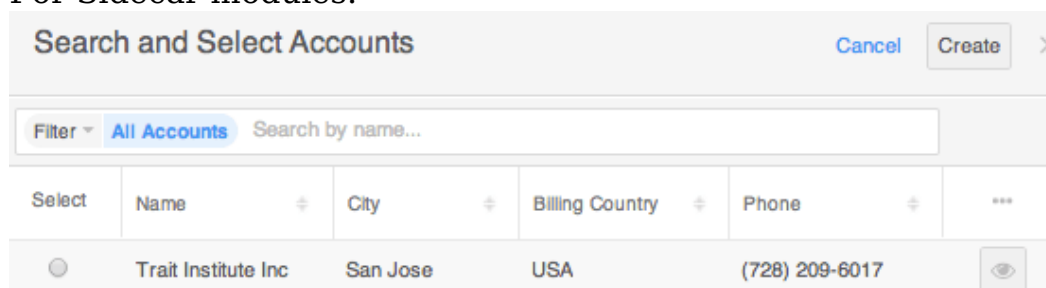

- **Popup Search** : Popup search layout is used to allow users to perform a search via the the popup window used to select records in the specified module.

For Sidecar modules:

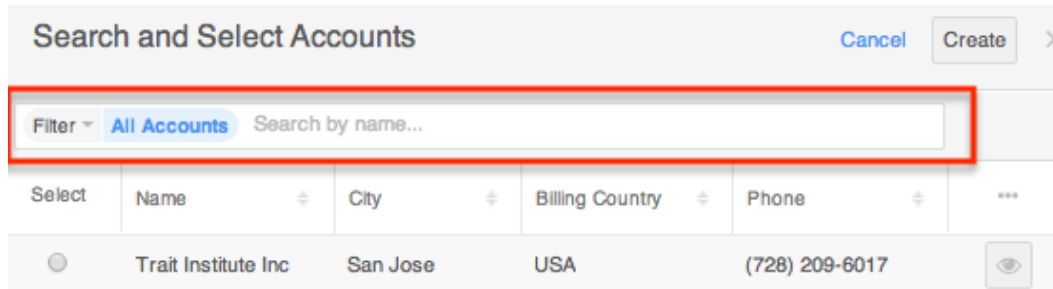

Layout Options

Administrators have the ability to configure the various layouts (e.g. record view, list view, etc.) available via Module Builder. Please note that the layouts can be configured via Admin > Studio as well once the module has been deployed. For more information on configuring layouts, please refer to the [Studio](#) documentation.

The following are some of the options available to administrators when configuring layouts via Module Builder:

- **Panels** : Every field on a layout is contained within a panel. Panels can be open or collapsed by default and have a title defining the panel. Panels can be organized to contain groups of similar or related fields to assist in organization.

Select the Pencil icon next to the Panel title to modify the title. Select the Collapsed? checkbox to default the panel as collapsed. Users can open and close panels as the wish.

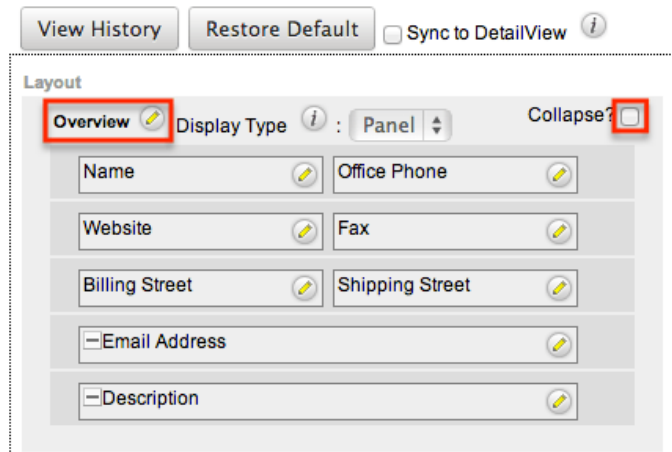

Note: The default panel name cannot be modified in Module Builder.

- **View History** : Sugar preserves a history of the changes made to each layout. Click "View History" and the History dialog box will display the timestamp of when changes occurred and allow you to preview the layout then restore if you wish. For more information on viewing the history of layouts, please refer to the [Viewing Layout History](#) section of this page.
- **Restore Defaults** : Sugar provides the option to restore a layout to its original default configuration. For more information on how to restore the

default layout, please refer to the [Restoring Layout Defaults](#) section of this page.

Editing Layouts

You can add, remove, hide, etc. the fields for the available layouts in the module by selecting the specific layout under the Packages panel to edit. Please note that the List View and Popup View layouts have columns where you can designate fields users can and cannot see.

Once a module is deployed, record views may be configured in Studio to display differently [based on the viewing user's role](#).

Editing Record View Layout

The following steps cover editing the Record View layout as an example:

1. Expand "Layouts" from the Packages panel under the desired module and select the layout (e.g. Record View) you wish to edit. The Record View layout will display in the main panel to the right.

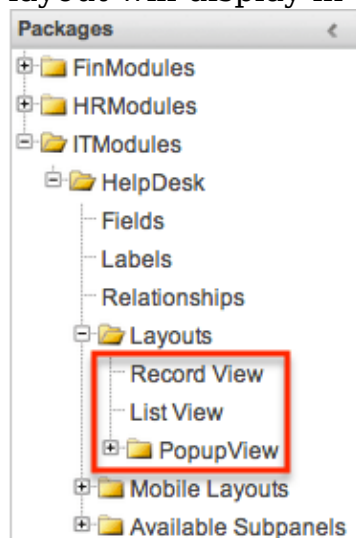

2. To add a field to the Record View layout, drag the field from the list of fields in the Toolbox to a "(filler)" location on the layout per your preference.
 - You can also drag a field to a location on the layout that already has a field in place. The newly added field and the existing field on the layout will swap places.

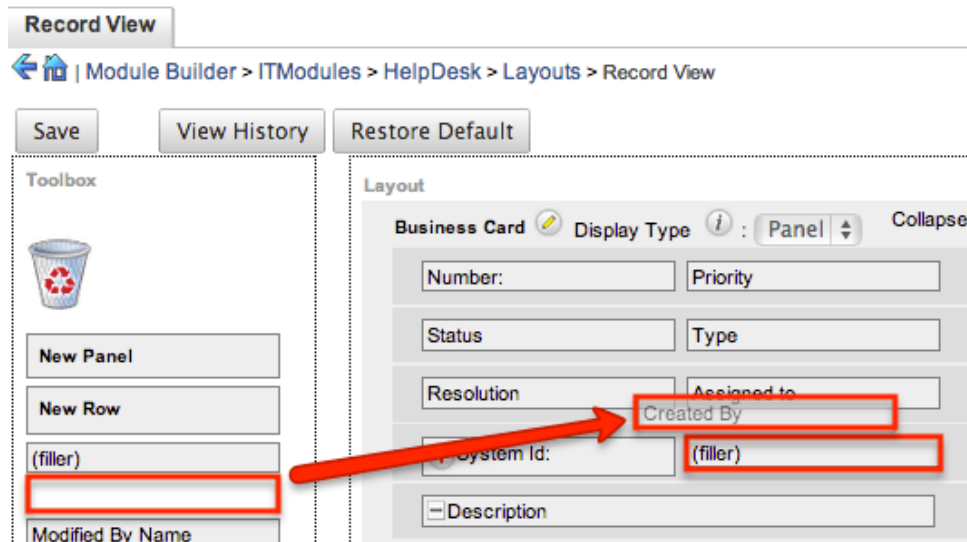

- To remove a field from the layout, drag and drop the field from the layout to the trash bin in the toolbox to remove the field from the layout. You may remove an entire row in the layout using the same method.

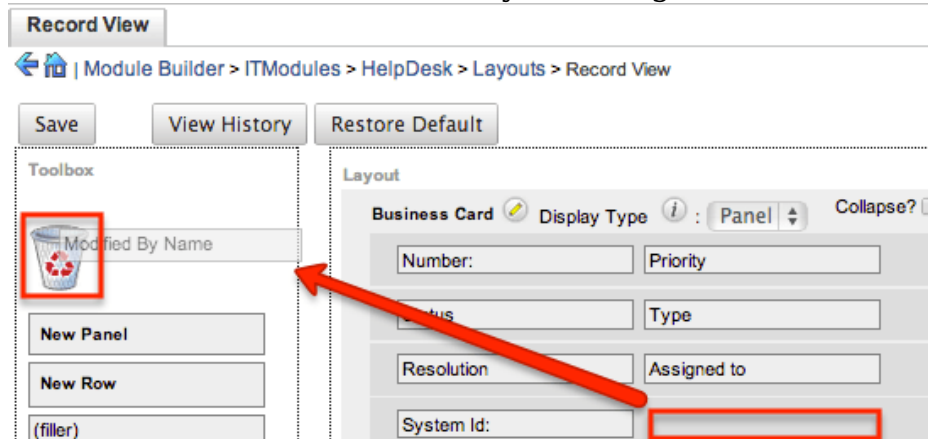

- To expand or minimize the field column in the layout, click the Plus icon (+) to stretch the field over two columns or click the Minus icon (-) to fit the field into one column.
 - Note:** The layout will display a "(filler)" if there is no field in that location.

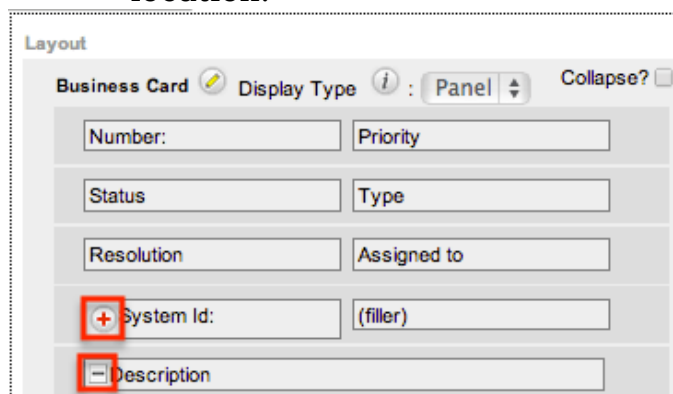

- To add a new row, drag the "New Row" item in the Toolbox to the layout to allow additional fields or blank spaces to be added.

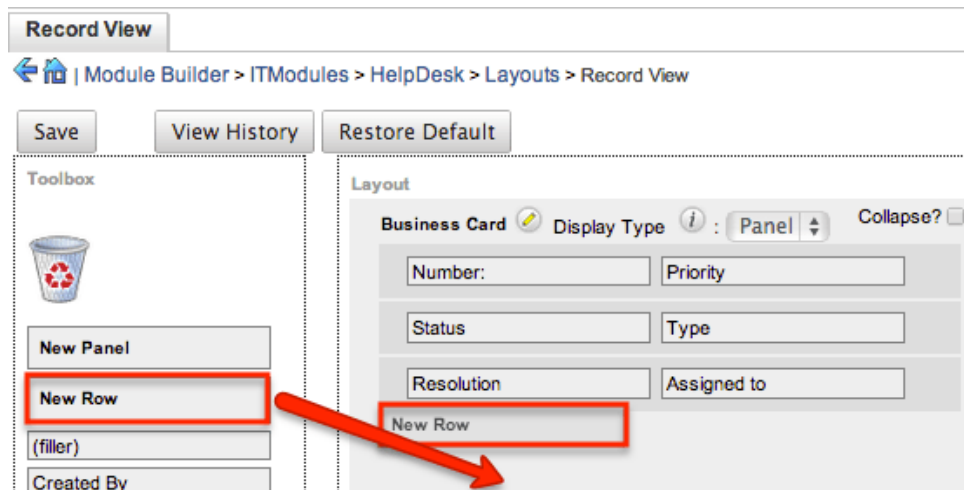

- To add a new panel, drag the "New Panel" item in the Toolbox to the layout to group different sets of fields together in the Record View layout.

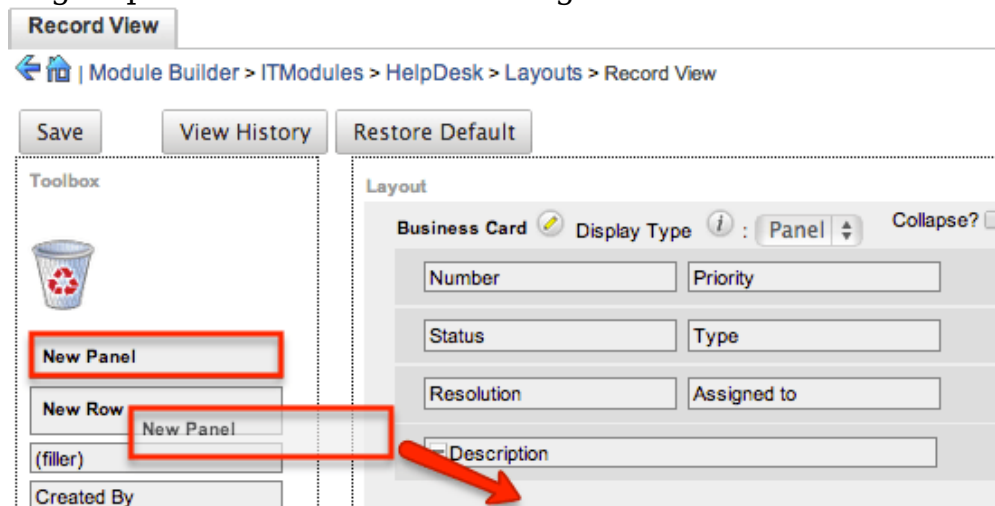

- Once the layout is finalized, click "Save" to preserve your changes.

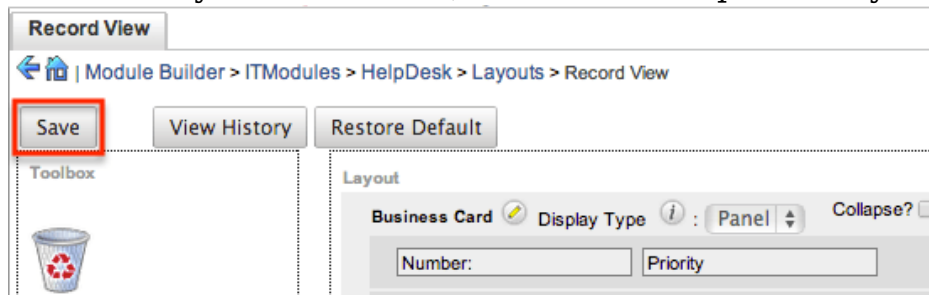

Note: It is recommended that dependent fields be placed below and/or to the right of the independent field in order to preserve the correct display of fields on the layout.

Editing List View Layout

Unlike the Record View layout, the List View layout has columns where you can designate fields users can and cannot see. When configuring the List View layout,

you will see three columns (Default, Available, Hidden) where fields can be dragged and dropped accordingly.

Please note that editing the List View layout affects the list of available fields for the module's list view dashlet as well since both are controlled by the same layout (List View). Once the custom module is deployed, the configurations made to the list view layout in Module Builder will be reflected in the Columns fields of the corresponding module dashlet's Configuration Options page. After the custom module is deployed, all succeeding changes to the List View layout can be made via [Studio](#). Please keep in mind that the custom module dashlet will not automatically reflect the Studio changes and users must edit the dashlet in order to view the changes, add new fields to the layout, etc.

Administrators can easily set the column widths for specific fields when configuring the List View layout. You can choose from a pre-defined list of width sizes (e.g. small, medium, large, etc.) that are available out-of-the-box with Sugar or enter a custom width value in pixels (e.g. 200) for Sidecar modules.

Note: When defining the column width for currency fields (e.g. Likely, Best, etc.), only "large" and above will apply because there is a minimum width requirement in Sugar for this field type. In addition, when defining a custom width for currency fields, the value must be 141px or wider.

The following table lists the available column width sizes in Sugar along with the corresponding width in pixels: **Table column widths**

Name	Width	Example
xxsmall	21px	Ex.
xsmall	42px	Exam
small	68px	Example
medium	110px	Example
large	178px	Example
xlarge	288px	Example
xxlarge	466px	Example

- **Default** : This column contains fields that are displayed in the layout.
- **Available** : Available fields are fields that will not show by default in the layout, but if the layout can be personalized, users can add these fields to their view of the layout. Not all list type layouts have an available fields section.
- **Hidden** : This column contains fields that will not be displayed in the layout.

The following steps cover editing the List View layout as an example:

1. Expand "Layouts" from the Packages panel under the desired module and select "List View".
2. To add a field to the List View layout, drag and drop the fields from the Hidden column to the Default column.
 - **Note:** The fields in the Default column will be available to add as display columns in the corresponding custom module dashlet (e.g. My HelpDesk).

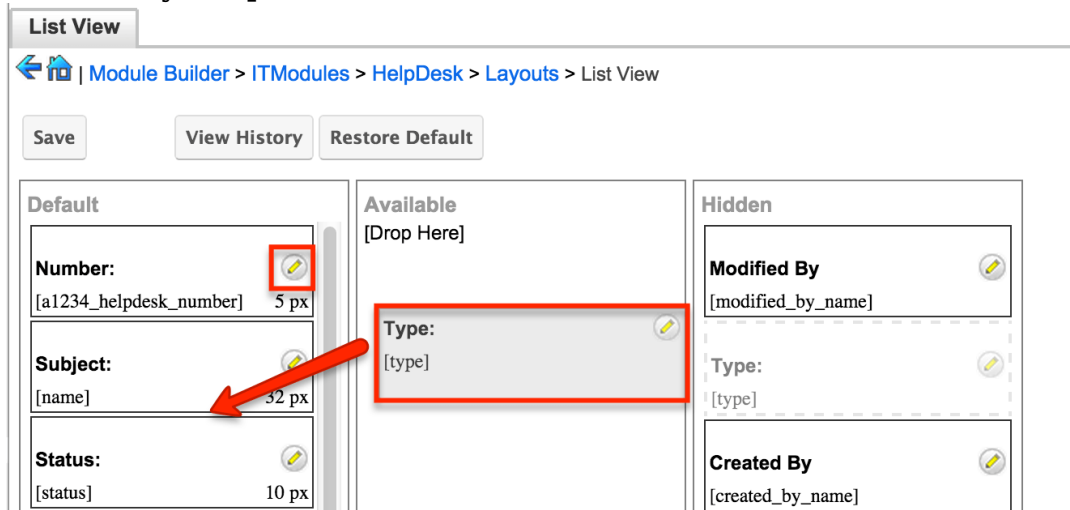

3. To remove a field from the layout, drag and drop the field from the Default column to the Hidden column.
4. To change the left-to-right order of the fields displayed on the list view, drag and drop fields up or down within the Default list.
 - **Note:** The order of fields designated for the List View layout also affects the order for the list of available fields in the corresponding custom module dashlet (e.g. My HelpDesk).
5. To modify the label of the field, as well as the width of the field, click the Pencil icon next to each field.
6. Enter the new label or select the width (e.g. small, medium, large, etc.) then click "Save". Please note the modified label will display in all List View layouts for this module.
 - **Note:** Administrators can choose from a pre-defined list of width sizes (e.g. default, small, medium, etc.). Please note that selecting the Default width will set the list view column to equal the Medium width size. Selecting "custom" from the list will allow you to enter a custom width value in the open box. The custom width value should be entered in pixels (e.g. 200) for the fields.

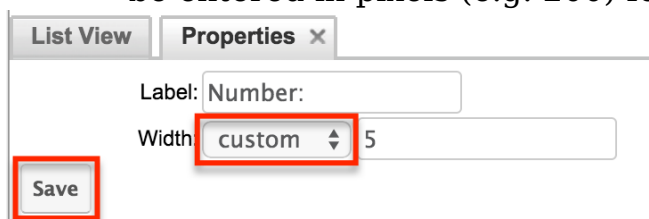

7. Once the layout is finalized, click "Save" to preserve your changes.

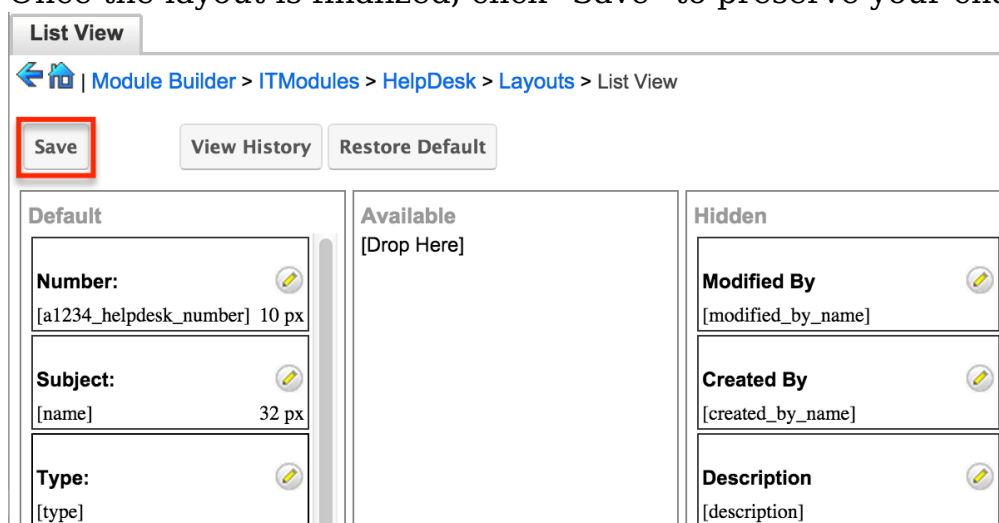

Mobile Layouts

Administrators can also configure the mobile layouts for Sugar Mobile by expanding "Mobile Layouts" for the desired module from the Packages panel. The list of available mobile layouts will display below and you can select the specific layout (e.g. Mobile EditView, Mobile ListView, etc.) you wish to configure.

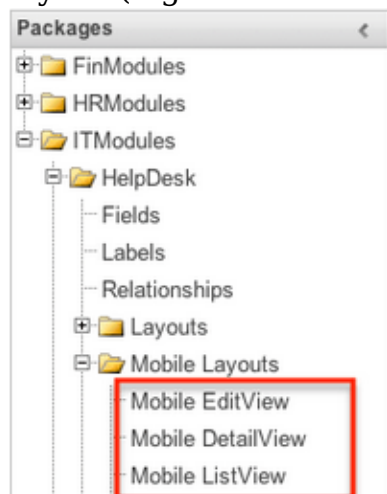

Mobile Layout Types

There are various mobile layouts in Sugar to represent the different areas of the Sugar Mobile application. Please note that not all layouts are available in every module and the different mobile applications will use the information defined here differently.

The following mobile layouts are available in Sugar:

-
- **Edit View** : Edit view layout is used in Sugar to modify or create records in the specified module.
 - **Detail View** : Detail view is used in Sugar to view the current data for a record within the specified module. Certain fields are translated to Sugar Mobile as buttons instead of data. For example, instead of seeing the phone number, there is a phone icon to be able to call the number on the record.
 - **List View** : List view layout is used in Sugar to view multiple records within the specified module. Only the first two fields in the list view section will be displayed in Sugar Mobile.

Mobile Layout Options

Administrators have the ability to configure the various layouts available via Module Builder. Please note that the mobile layouts can be configured via Admin > Studio as well once the module has been deployed. For more information on configuring layouts, please refer to the [Studio](#) documentation.

The following are some of the available options when configuring mobile layouts via Module Builder:

- **View History** : Sugar preserves a history of the changes made to each layout. Click "View History" and the History dialog box will display the timestamp of when changes occurred and allow you to preview the layout then restore if you wish. For more information on viewing the history of layouts, please refer to the [Viewing Layout History](#) section of this page.
- **Restore Defaults** : Sugar provides the option to restore a layout to its original default configuration. For more information on how to restore the default layout, please refer to the [Restoring Layout Defaults](#) section of this page.

Editing Mobile Layouts

You can add, remove, hide, etc. the fields for the available layouts in "Mobile Layouts" by selecting the specific layout under the Packages panel to edit. Please note that the Mobile EditView and DetailView layouts are modified in similar fashions. The Mobile ListView layout has columns where you can designate fields users can and cannot see.

The following steps cover editing the Mobile EditView layout as an example:

1. Expand "Mobile Layouts" from the Packages panel under the desired module and select "Mobile EditView". The selected layout will display in the main panel to the right.

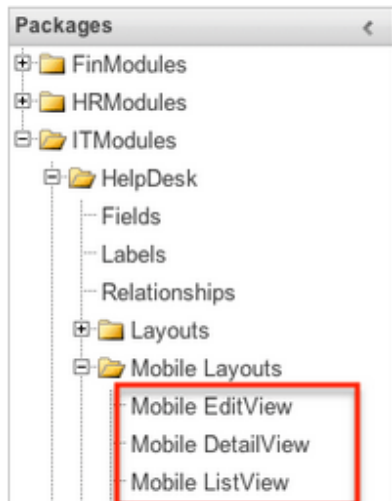

- To add a field to the Mobile EditView layout, drag the field from the list of fields in the Toolbox to a "(filler)" location on the layout per your preference.
 - You can also drag a field to a location on the layout that already has a field in place. The newly added field and the existing field on the layout will swap places.

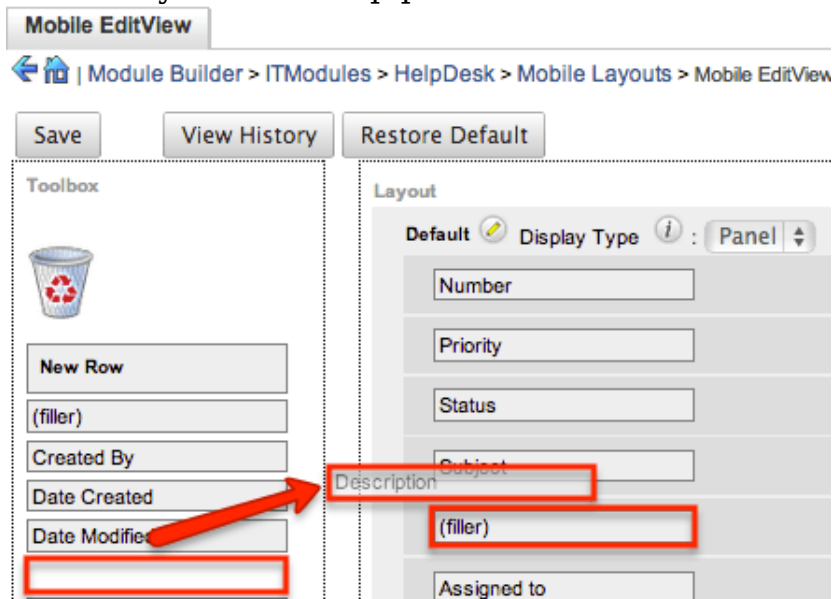

- To remove a field from the layout, drag and drop the field from the layout to the trash bin in the Toolbox to remove the field from the layout. You may remove an entire row in the layout using the same method.

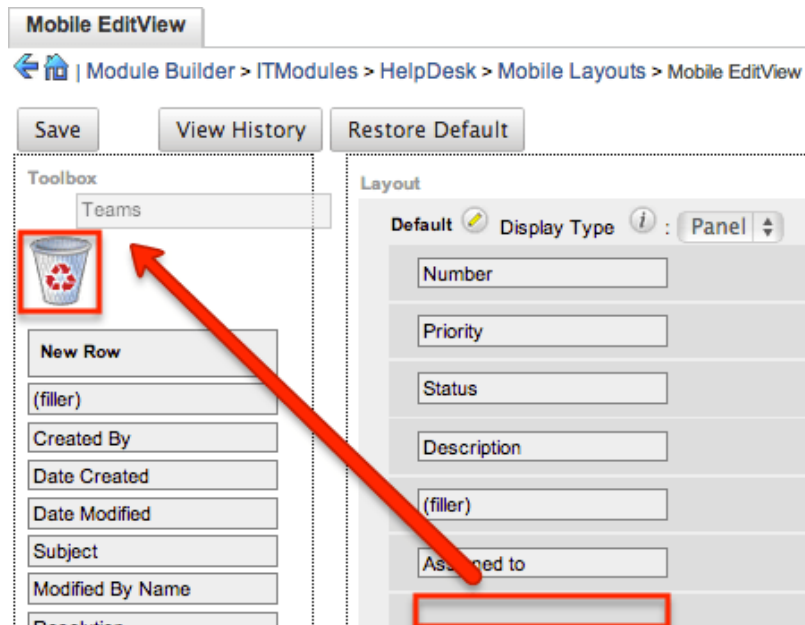

4. To add a new row, drag the "New Row" item in the Toolbox to the layout to allow additional fields or blank spaces to be added.

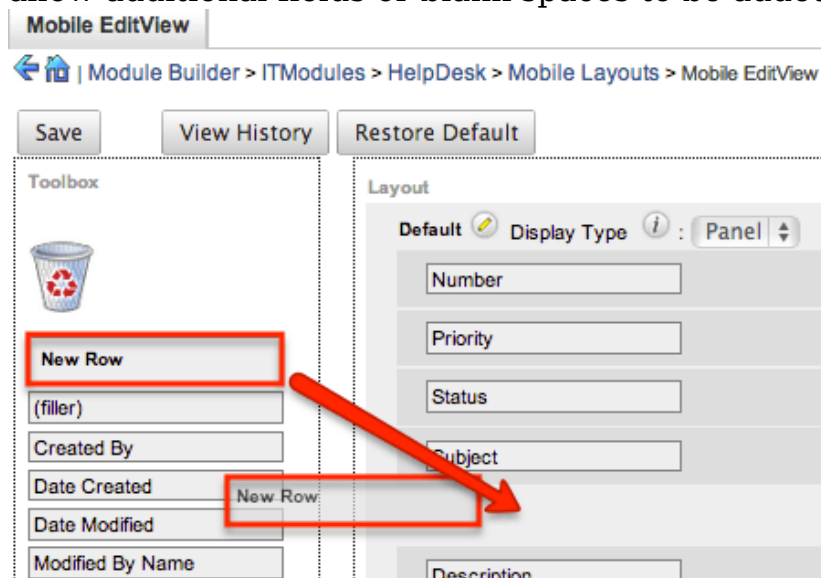

5. Once the layout is finalized, click "Save" to preserve your changes.

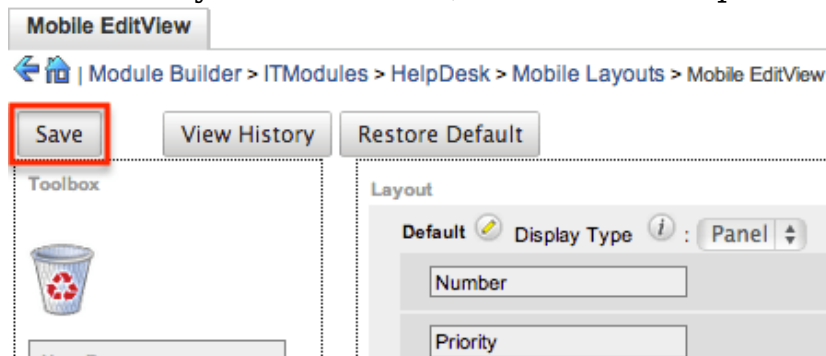

Unlike the Mobile EditView layout, the Mobile ListView layout has columns where you can designate fields users can and cannot see. When configuring the Mobile

ListView layout, you will see three columns (Default, Available, Hidden) where fields can be dragged and dropped accordingly.

- **Default** : This column contains fields that are displayed on the list view.
- **Available** : Available fields are fields that will not show by default in the layout, but if the layout can be personalized, users can add these fields to their view of the layout. Not all list type layouts have an available fields section.
- **Hidden** : This column contains fields that will not be displayed on the list view.

The following steps cover editing the Mobile ListView layout as an example:

1. Expand "Layouts" from the Packages panel under the desired module and select "Mobile ListView".
2. To add a field to the Mobile ListView layout, drag and drop the fields from the Hidden column to the Default column.

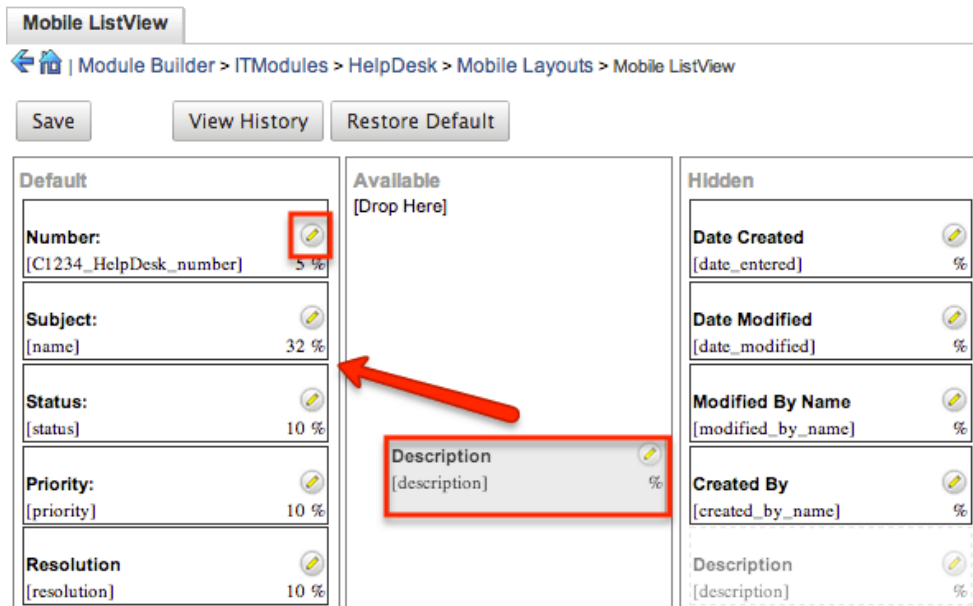

3. Click the Pencil icon to modify the label of the field as well as the width percentage the field will take up in the list view. Please note that the modified label will display in all List View layouts in Sugar Mobile.
4. Once the layout is finalized, click "Save" to preserve your changes.

Available Subpanels

Related records between modules in Sugar are commonly displayed in Subpanels. Similar to list type layouts, administrators can modify the available subpanel layouts to change which fields are shown in a module's subpanel. You can add or remove fields for these subpanels depending on the information that you want to display to users. To access the subpanels section in Module Builder, expand

"Available Subpanels" from the Packages panel under the desired module. The available subpanel for the selected module will appear to the right of the screen.

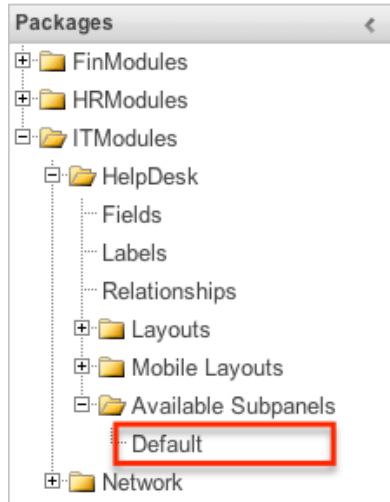

Subpanel Options

When configuring the Subpanel layout in Module Builder, there are some available options which allow you to view historical layout changes as well as restore the default layout. Please note that the subpanel layout can be configured via Admin > Studio as well once the module has been deployed. For more information on configuring layouts, please refer to the [Subpanels](#) section of the Studio documentation.

- **View History** : Sugar keeps a history of the changes made to each subpanel. These changes and when they occurred can be viewed and restored via "View History". For more information on viewing the history of subpanels, please refer to the [Viewing Layout History](#) section of this page.
- **Restore Defaults** : Sugar also contains the ability to restore a subpanel to its original default configuration. For more information on how to reset a subpanel to default, please refer to the [Restoring Layout Defaults](#) section of this page.

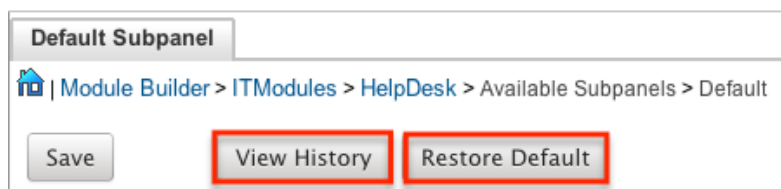

Editing Subpanel Layout

Use the following steps to modify a subpanel via Module Builder:

1. Expand "Available Subpanels" from the Packages panel under the desired module and select the subpanel you wish to edit. The selected subpanel layout will display to the right in the main panel.

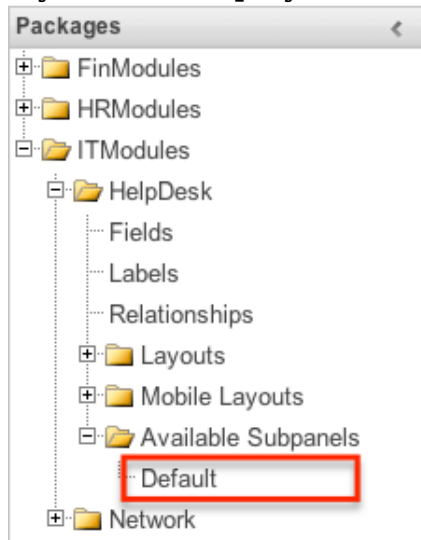

2. To add a field to the Subpanel layout, drag and drop the fields from the Hidden column to the Default column.
 - You can drag the field up and down the list to change the position of the field in the subpanel.

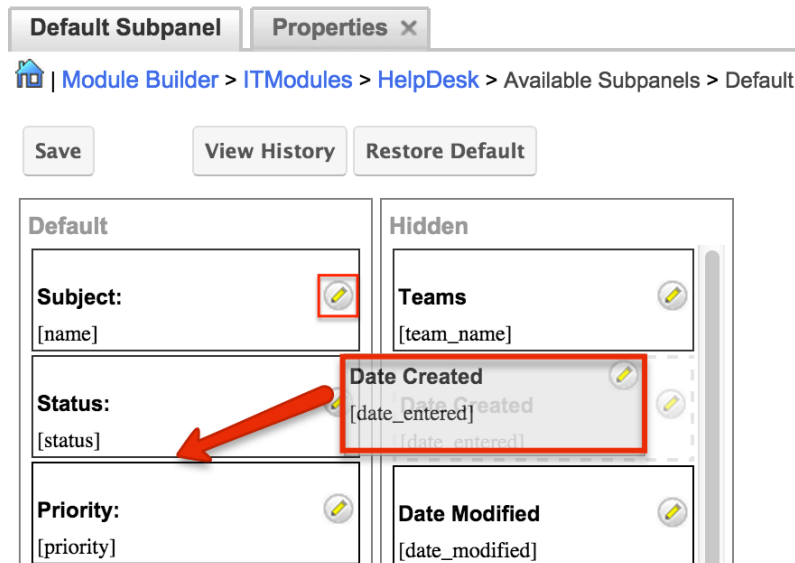

3. To remove a field, drag and drop the fields from the Default column to the Hidden column.

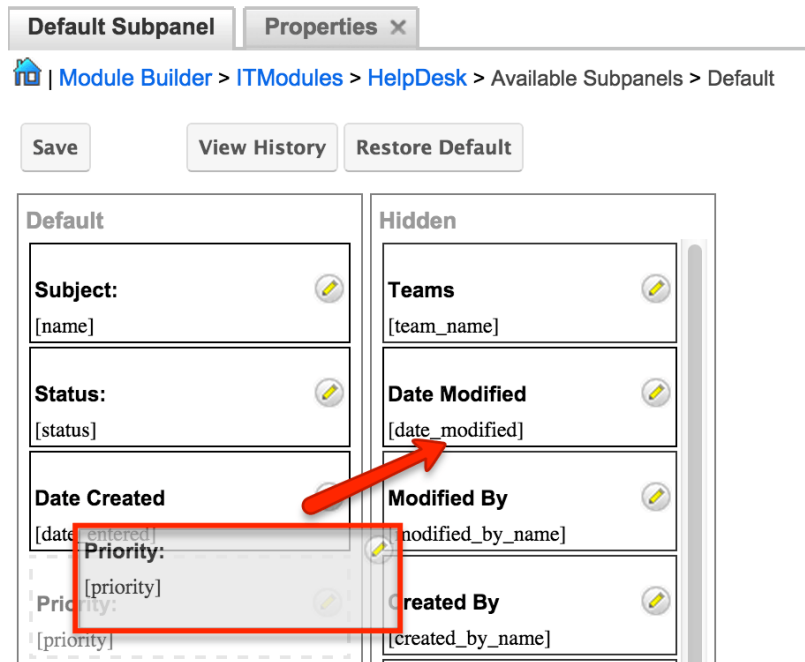

4. Click the Pencil icon to change the column width of the field in the subpanel.
 - **Note:** Administrators can choose from a pre-defined list of width sizes (e.g. default, small, medium, etc.). Please note that selecting the Default width will set the list view column to equal the Medium width size. Selecting "custom" from the list will allow you to enter a custom width value in the open box. The custom width value should be entered in pixels (e.g. 200) for the fields.
 - When defining the column width for currency fields (e.g. Likely, Best, etc.), only "large" and above applies because there is a minimum width requirement in Sugar for this field type. In addition, when defining a custom width for currency fields, the value must be 141px or wider.

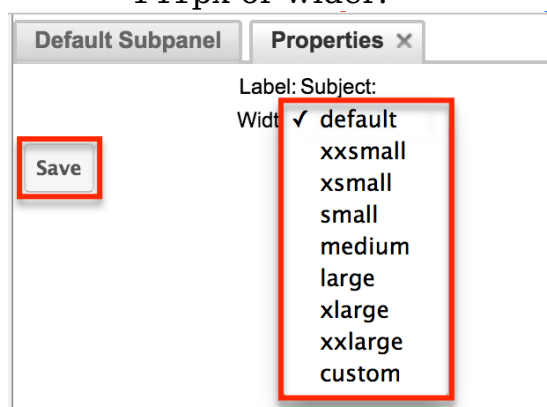

5. Once the subpanel layout is finalized, click "Save" to preserve your changes.

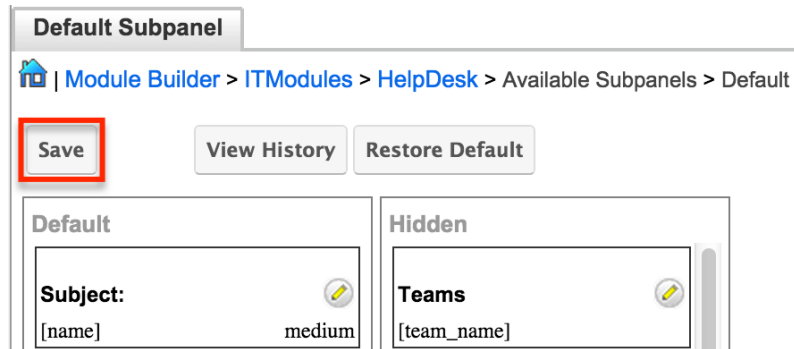

Using Sugar Logic

Sugar Logic allows administrators to write simple formulas and logic checks to provide a calculation for a field or to set the visibility of a field. A formula specifies one or more field values along with operators and functions that are mathematical or logical. When you execute a formula, Sugar performs the calculation to derive the value. When a field is used in a formula, Sugar recalculates the value whenever a user updates it and saves the record. Similarly, if you update a formula, Sugar recalculates the field value based on the updated formula. For the complete list of Sugar Logic functions and how to use them, please refer to the [Studio](#) documentation.

For more information regarding the types of fields that support the use of Sugar Logic, please refer to the [Field Options](#) section of this page.

Viewing Layout History

Layouts, subpanels, and mobile layouts keep a history of the last ten changes made to each layout. To view the history for any of these layouts, simply click "View History" on the layout editor view in Module Builder.

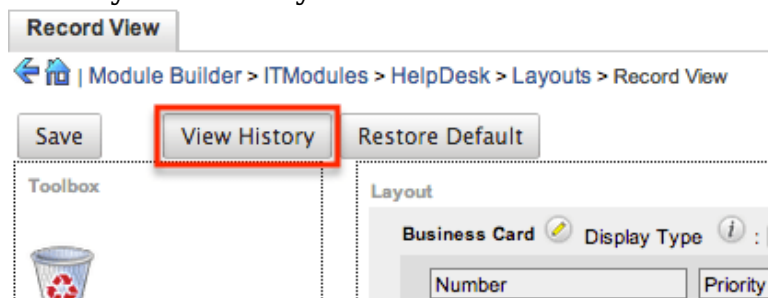

The History dialog box will open up displaying the timestamps of when changes occurred and allow you to preview the layout by clicking the Preview button.

HelpDesk : Record View history		
TimeStamp		
09/24/2013 04:35pm	Preview	Restore
09/24/2013 04:35pm	Preview	Restore
09/24/2013 04:35pm	Preview	Restore
09/24/2013 04:35pm	Preview	Restore
09/24/2013 04:35pm	Preview	Restore
09/24/2013 04:34pm	Preview	Restore
09/24/2013 04:34pm	Preview	Restore
09/24/2013 04:31pm	Preview	Restore
09/24/2013 04:31pm	Preview	Restore
09/24/2013 04:27pm	Preview	Restore

The preview will show the details of the layout as of the specific time it was saved. To restore the layout to the particular version you are viewing, simply click the Restore button from under the Preview tab or in the History dialog box. The restored layout will load into the layout editor allowing you to make any additional changes as necessary. Click "Save" to preserve your changes.

Record View Preview x

Close **Restore**

Layout Preview

Business Card

Number Priority

Assigned to

Type

Modified By Name

Description

HelpDesk : Record View history		
TimeStamp		
09/24/2013 04:35pm	Preview	Restore
09/24/2013 04:35pm	Preview	Restore
09/24/2013 04:35pm	Preview	Restore

Restoring Layout Defaults

Many layouts, subpanels, and mobile layouts can be restored to their original default configuration. To restore the default for any of these layouts, simply select "Restore Default" from the edit layout screen in Module Builder.

View History **Restore Default** Sync to DetailView *i*

Layout

Overview *i* Display Type *i* : Panel Collapse?

Name Office Phone

Website Fax

The default layout will load into the editor allowing you to make changes as necessary. Click "Save" to preserve your changes.

Deleting Modules

If a module is invalid or should no longer appear in a package, it may be deleted from Module Builder. Please note that deleting a module from a package will not remove the module from any instances where the package was deployed. For more information on how to uninstall a deployed package from an instance, please refer to the [Module Loader](#) documentation.

Use the following steps to delete a module from a package via Module Builder:

1. Select the desired package and module from the Packages panel or the main panel.

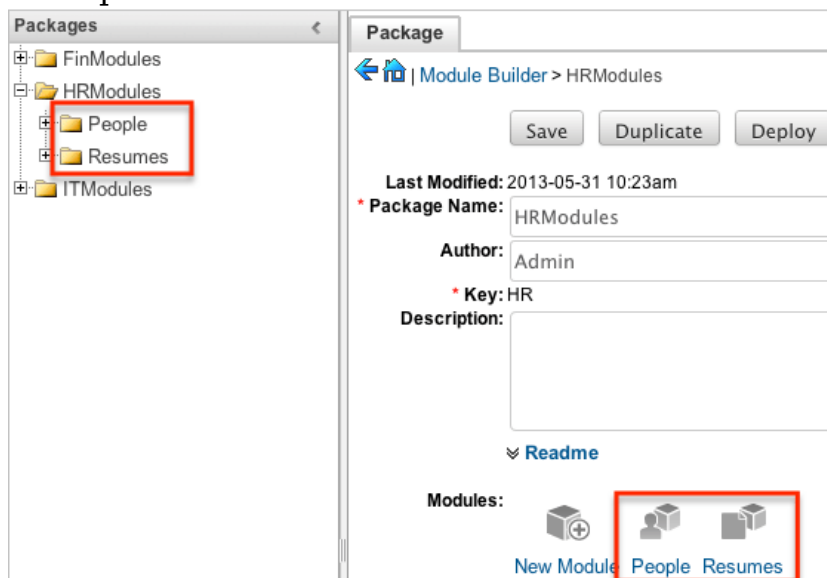

2. Click "Delete" to remove the module.

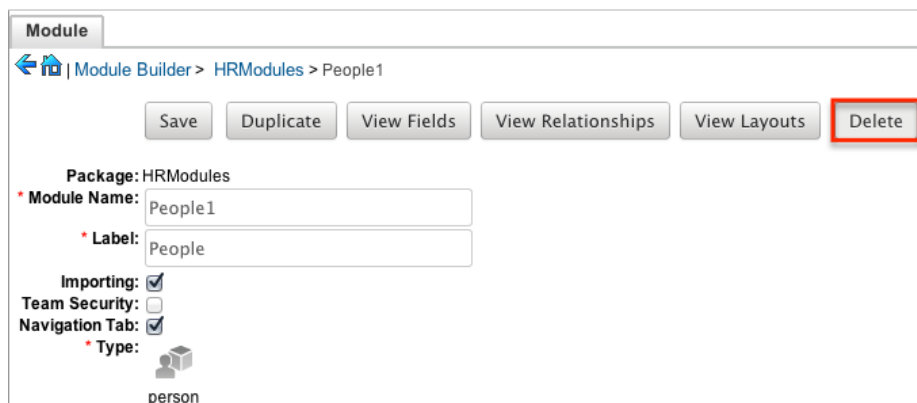

3. A pop-up message will display asking for confirmation. Click "Ok" to proceed.

Module Loader

Overview

Module Loader is used to install a variety of custom file packages, including custom modules, into a Sugar instance. Using Module Loader, you can also manage and uninstall these packages, all done through Sugar's user interface. Packages are uploaded as a ZIP file from an administrator's local computer and then, when deployed, will force changes upon the instance's filesystem and database.

Custom module packages can be created and modified in [Module Builder](#), and then, after deployment, they will show in Module Loader. They can also be exported from Module Builder in one instance, and then uploaded to another instance via Module Loader.

Module Loader Layout

Module Loader consists of three panels. The panels include all necessary information about the packages, and also include different action buttons, explained in [Module Loader Fields](#). The panels are:

- **Installed Packages** : This panel shows all installed packages. On this panel, you have the option to uninstall or disable installed packages. After installation, the packages will move from the Uploaded Packages panel to this panel.

Module Loader

The following extensions are installed on this system:

Name	Action	Enable/Disable	Type
Dashboard Manager	<input type="button" value="Uninstall"/>	<input type="button" value="Disable"/>	module

- **Module Upload** : This panel consists of an upload option where files can be uploaded to Sugar via a browser file selection window. Please review [Uploading Modules](#) for more information on using this panel.

Module No file chosen

- **Uploaded Packages** : This panel shows all packages that have been uploaded to Sugar, but have not yet been installed, or have been uninstalled. Packages can be installed or deleted from Sugar using this

panel.

Name	Install	Delete	Type
SchedulerAlerts	<input type="button" value="Install"/>	<input type="button" value="Delete Package"/>	Module

Module Loader Fields

Module Loader contains different fields on the [Installed Packages and Uploaded Packages panels](#). Each set of fields show relevant and identifying information about the module package.

The Installed Packages panel consists of the following fields:

Field	Description
Name	The name of the package, pulled from the manifest.php file of the package
Action	Button allowing you to uninstall the package from your Sugar instance if the package is marked as uninstalleable in the manifest.php file of the package
Enable/Disable	Button allowing you to enable or disable the functionality of the package without uninstalling Note: Always perform a Quick Repair and Rebuild after disabling and then re-enabling a package via Module Loader.
Type	Describes the type of package, pulled from the manifest.php file of the package
Version	The version of the package pulled from manifest.php file of the package
Date Installed	The date and time that the package was installed
Description	The description of the package pulled from the manifest.php file of the package

The Uploaded Packages panel consists of the following fields:

Field	Description
Name	The name of the package pulled from

	the manifest.php file of the package
Install	Button allowing you to install the package to your Sugar instance
Delete	Button allowing you to delete the package from your Sugar instance
Type	Describes the type of package, pulled from the manifest.php file of the package
Version	The version of the package, pulled from manifest.php file of the package
Date Published	The date and time that the package was initially created from the publisher
Uninstallable	Tells you if the package is uninstallable from the manifest.php file of the package
Description	The description of the package pulled from the manifest.php file of the package

Uploading Packages

After receiving the file that you would like to install, you must first upload it to your Sugar instance. To upload a file, follow the following steps:

1. Navigate to Admin > Module Loader
2. Click the "Choose File" button in the Module Upload panel to open a file selection window from your browser

The screenshot shows a form with the label 'Module' on the left. To its right is a text input field containing 'No file chosen'. A 'Choose File' button is positioned to the left of the input field and is highlighted with a red rectangular box. To the right of the input field is an 'Upload' button.

3. Select the file from your local computer
4. After you select your file, click the "Upload" button to complete the process

The screenshot shows the same form as above, but the text input field now contains the filename 'DashboardManager_v1.7.zip'. The 'Upload' button is highlighted with a red rectangular box.

5. After it has been uploaded, the package will show in the Uploaded Packages panel

Module

Name	Install	Delete	Type
Dashboard Manager	<input type="button" value="Install"/>	<input type="button" value="Delete Package"/>	Module

Installing Packages

After uploading a package to Module Loader, it must be installed for the package's contents to take effect on your instance. To install a package, follow the following steps:

1. Follow the steps to [upload your package](#) to Module Loader.
2. Click the "Install" button on the Uploaded Packages panel.

Name	Install	Delete	Type
Dashboard Manager	<input type="button" value="Install"/>	<input type="button" value="Delete Package"/>	Module

3. You will be brought to the installation screen to confirm that the packages should be installed and to read and accept any license or readme documentation as needed. Click "Commit" when ready to run the installation.

Ready To Install

Please read the following License Agreement:

PLEASE READ THIS MASTER SUBSCRIPTION AGREEMENT CAREFULLY BEFORE ACCEPTING. THE TERMS AND CONDITIONS OF THIS MASTER SUBSCRIPTION AGREEMENT, ANY ADDITIONAL TERMS AND ANY ORDER FORMS ENTERED INTO BY YOU AND SUGARCRM ARE COLLECTIVELY REFERRED TO AS THE "AGREEMENT." UNLESS OTHERWISE DEFINED HEREIN, CAPITALIZED TERMS SHALL HAVE THE MEANINGS SET FORTH IN SECTION 11 BELOW.

BY ACCEPTING YOU ARE AGREEING ON BEHALF OF THE ENTITY ORDERING THE

Accept
 Deny

4. The next page will show a progress bar and a completion notice. If there are any errors, they will be displayed with a verbose explanation of what went wrong. If not, click "Display Log" to show what happened during the installation process.
 - **Note:** To sustain the stability, security, and integrity of Sugar's cloud service environment, all installed packages are scanned to check for code not conforming to environmental agreements. Any package that fails this scanner will not be installed and the installer will produce a reason for the failed installation. If this happens, please contact the developer of your package for more information.
5. Click "Back to Module Loader" when complete to return to Module Loader.

If you do not need to install any further packages, you can navigate to any other section of Sugar as need be.

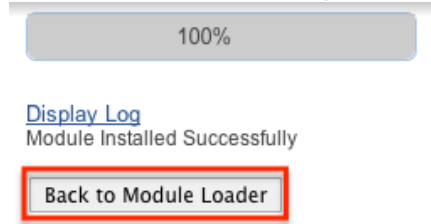

Uninstalling Packages

After a package has been [installed](#) in your Sugar instance, it can be removed if it is no longer needed. When uninstalled, the package will remove any available customizations to your instance from the filesystem and database.

Note: Packages have to be defined as "Uninstallable" in the manifest.php file of the package to be able to be uninstalled.

To uninstall a package, perform the following steps:

1. Navigate to Admin > Module Loader.
2. Locate the package you would like to uninstall in the Installed Packages panel.
3. Click the "Uninstall" button.

The following extensions are installed on this system:

Name	Action	Enable/Disable	Type
Dashboard Manager	Uninstall	Disable	module

- **Note:** If you do not see an Uninstall button next to your package, it may be caused by one of the following circumstances:
 - There may be a newer version of the package installed that has an Uninstall button and that package must be uninstalled first.
 - The manifest.php file may not define the package as uninstallable.
 - The package may be missing files that are critical to performing the uninstall.
- 4. If the package has added any database tables to your instance, you will see a selection whether to remove or retain the database tables. If the database tables include any information you would like to keep, select the "Do Not Remove Tables" option. An example of this would be if you are uninstalling a custom module but will be reinstalling a new version of the same module. You would want to keep the data but remove any files associated with the old module that will be replaced with the new package.
- 5. Click "Commit" when you are ready to uninstall the package.

Ready To Uninstall

Remove Tables Do Not Remove Tables

- The next page will show a progress bar and a completion notice. If there are any errors, they will be displayed with a verbose explanation of what went wrong. If not, click "Display Log" to show what happened during the uninstall process.
- Click "Back to Module Loader" when complete to return to Module Loader. If you do not need to uninstall any further packages, you can navigate to any other section of Sugar as need be.

100%

Display Log

Removing for dash_DashboardBackups
Removing for dash_DashboardBackups
Removing for dash_DashboardBackups
Removing for dash_DashboardBackups
Removing for dash_DashboardBackups
Removing for dash_DashboardBackups
Removing for dash_DashboardBackups
Removing for dash_DashboardBackups
Removing for dash_DashboardBackups
Removing for dash_DashboardManager
Removing for dash_DashboardManager
Removing for dash_DashboardManager
Removing for dash_DashboardManager
Removing for dash_DashboardManager
Removing for dash_DashboardManager
Removing for dash_DashboardManager
Removing for dash_DashboardManager

Complete

Module Uninstalled Successfully

- After the package has been uninstalled, it can be deleted from your instance via the Uploaded Packages panel.

Name	Install	Delete	Type
Dashboard Manager	<input type="button" value="Install"/>	<input checked="" type="button" value="Delete Package"/>	Module

Installing Role-Based Customizations

Administrators have the ability to create role-based custom dropdown lists and role-based custom record views via Studio and Dropdown Editor. These role-based customizations are included when exporting customizations via Studio. When the exported package is then installed on a destination instance, administrators will be given the opportunity to map the package's customized roles to the destination

instance's roles. Sugar will attempt to select a matching role from amongst the destination instance's roles. The role mapping can be manually altered by selecting a different role from the dropdown menus. If you wish to not install a role's customizations, choose "Do not map this role" in the dropdown. Once the mappings are correctly set, click "Commit" to proceed with installing the package.

Map ACL Roles

Package Roles	Instance Roles
Sales Administrator ID: 40df175a-e723-804a-8af7-556cde10469e	Sales Administrator (matches by Name)
Customer Support Administrator ID: 4ef9edf3-9145-73d1-5682-556cde2fd660	Customer Support Administrator (matches by Name)
Marketing Administrator ID: 47fcf6db-c11e-8032-2174-556cdef11e45	-- Do not map this role --

Importing Role-Based Custom Record Views

If the package contains role-based custom record views, the mapped roles in the destination instance will be updated to match the package's custom record views. Any prior customizations made record view for the destination instance's role will be overwritten. Regardless of any prior customizations made on the destination instance, all mapped roles will be updated to completely match the imported role-based record views. For more information about creating role-based custom record views, please refer to the [Studio](#) documentation.

Importing Role-Based Custom Dropdown Lists

When a package contains non-stock dropdown values for the default role, the destination instance's default role-list will be completely overwritten by the package.

If the package, the destination instance, or both include role-based custom dropdown lists, Sugar will take the destination instance's original customized role-lists into consideration when deciding on the resulting customized role-lists. The following table demonstrates how default custom dropdown lists and role-based custom dropdown lists will be affected:

- When a cell indicates "Undefined", it means that the role does not have a customized role-list, and it will inherit the custom default list.
- When a cell indicates "Any", it means that the role's role-list is customized, but any of the possible combinations of values will produce the same result.

- When a cell indicates "Empty", it means that the role's role-list is customized to have no enabled values.
- In every situation, the resulting default role-list will be overwritten to exactly match the package's default role-list.

Situation and Outcome	Destination Default Role-List	Destination Custom Role-List	Package Default Role-List	Package Custom Role-List	Resulting Default Role-List	Resulting Custom Role-List
The destination and package match. The destination remains unchanged.	A,B,C	B,C	A,B,C	B,C	A,B,C	B,C
This role is not customized in the destination or package. This role will not be customized and will inherit the default role-list.	A,B,C	<i>Undefined</i>	X,Y,Z	<i>Undefined</i>	X,Y,Z	<i>Undefined</i>
This role is customized in both the destination and package. This role's custom	A,B,C	<i>Any</i>	A,B,C	A,C	A,B,C	A,C

role-list is updated to match the package's.						
This role is customized in both the destination and package. This role's custom role-list is updated to match the package's.	A,B,C	<i>Any</i>	X,Y,Z	X,Y	X,Y,Z	X,Y
This role's custom role-list has no enabled options in the package. This role's custom role-list will have no enabled values.	A,B,C	<i>Any, Empty, or Undefined</i>	X,Y,Z	<i>Empty</i>	X,Y,Z	<i>Empty</i>
This role is customized in the destination but not in the package. This role's custom role-list is reduced to	A,B,C	A,C	A,B,E	<i>Undefined</i>	A,B,E	A

the values present in both the destination's custom role-list and the package's default role-list.						
<p>This role is customized in the destination but not in the package.</p> <p>This role's custom role-list will have no enabled values since there is no overlap between the destination's custom role-list and the package's default role-list.</p>	A,B,C	Any	X,Y,Z	Undefined	X,Y,Z	Empty
<p>This role is customized in the destination but not in the package.</p> <p>This role's</p>	A,B,C	C	A,B,E	Undefined	A,B,E	Empty

custom role-list will have no enabled values since there is no overlap between the destination's custom role-list and the package's default role-list.						
--	--	--	--	--	--	--

For more information about creating role-based custom dropdown lists, please refer to the [Dropdown Editor](#) documentation.

Last Modified: 2019-12-05 15:47:53

Sugar Portal

Overview

The Sugar Portal is a powerful tool that allows Sugar users to interact with customers and share information related to multiple modules (Bugs, Cases, Knowledge Base). The portal allows customers to log in and review information directly from your Sugar instance and perform actions such as submitting cases and bugs, communicating with your employees regarding the cases and bugs, as well as reviewing knowledge base articles. Please note that in order to enable the portal for your instance, the Enable Portal option must be enabled via Admin > Sugar Portal. This will enable a Portal API User in Admin > User Management which must be left enabled in order for portal users to authenticate. This documentation covers the basics on how to configure the various portal settings, the look and feel of the portal, as well as configure the layout for the available modules (e.g. Cases, Bugs) in the portal.

For more information on how a Sugar user can interface with the portal, refer to the [Portal Deployment User Guide](#).

For more information on how your customers can interface with the portal, refer to the [Portal User Guide](#).

Note: The Cases and Bugs modules are not available for Sugar Sell users. For more information on license types and the functionality available for each, refer to the [User Management](#) documentation.

Configure Portal

The Configure Portal page allows administrators to enable the portal as well as configure different aspects of the portal interface such as enabling/disabling modules, defining the number of records to display per list view results set, etc. For more information on how these settings are applied in the portal, refer to the [Portal User Guide](#).

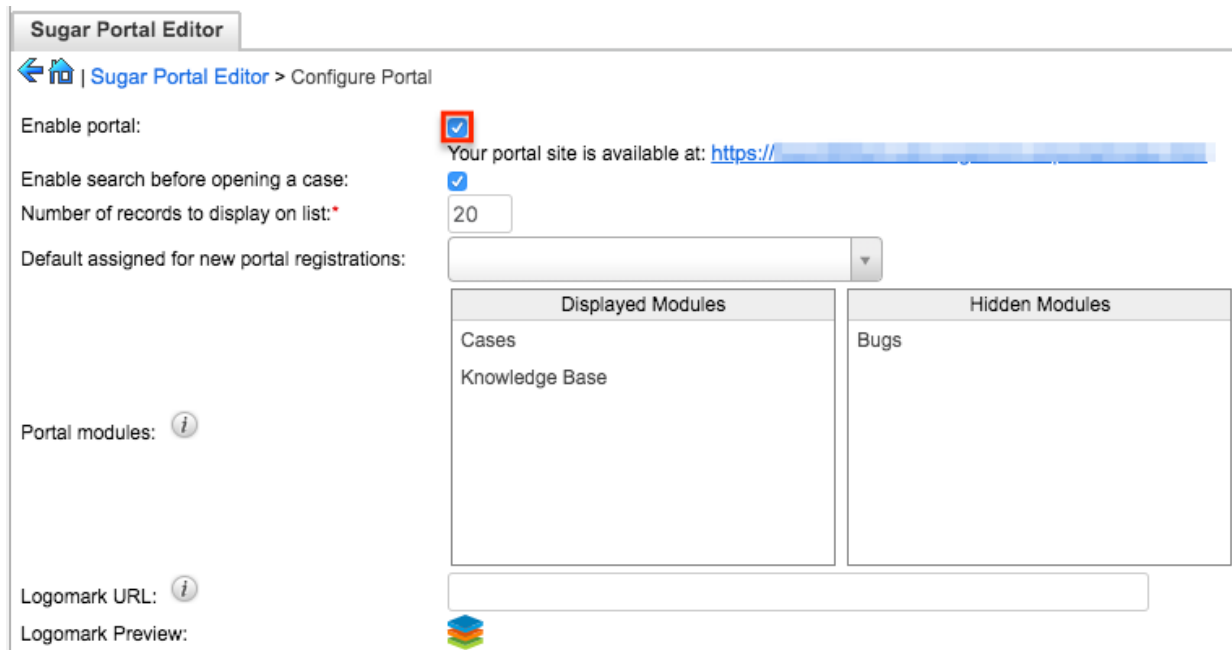

The following settings are available to configure when setting up your portal:

Field	Description
Enable portal	Enable the checkbox to have the portal enabled for customers. After enabling the portal and clicking "Save", the portal URL will appear under the checkbox which is where you can access the

	portal for your instance.
Enable search before opening a case	The case deflection search box that displays at the top of the Portal home page may be disabled by unchecking the box. If the option is disabled, the Create Case button will display instead on the portal's home page.
Number of records to display on list	Enter the maximum number of records to display per list view results set in the portal. By default, this is set to 20 records per results set. Note: This value must be no greater than 100.
Default assigned for new portal registrations	Select the Sugar user that will be assigned to the contact records created from the portal registrations.
Portal Modules	Select which modules will appear in the portal's navigation bar by dragging and dropping the module between the Displayed Modules and Hidden Modules column. You can also designate the order of the modules displayed in the navigation bar by selecting the module in the Displayed Modules column and moving it up or down. Note: If you wish to completely remove access to the module from the portal, then you will need to disable access to the module via Admin > Role Management for the Customer Self-Service Portal Role. For more information on roles, refer to the Role Management documentation.
Logomark URL	Enter the URL to a custom logomark image that you wish to display on the navigation bar at the top of the portal. Note: The image must have a publicly accessible URL and cannot be uploaded from your local machine. The recommended logomark dimensions are 22 x 22 pixels. Any image that is larger in either direction will be scaled down to these dimensions.
Logomark Preview	Displays a preview of the custom

	logomark image.
Logo URL	<p>Enter the URL to a custom logo image that will appear on the login page of the portal. If no logo image is added, then the logomark image will be used instead.</p> <p>Note: The Logomark URL field must be completed first before you can enter in the Logo URL. The image must have a publicly accessible URL and cannot be uploaded from your local machine. The recommended logo width is 200 pixels. Any image that is larger in either direction will be scaled down to these dimensions.</p>
Logo Preview	Displays a preview of the custom logo image.
Portal Contact Information	<p>Enter the company's contact information (i.e. phone, email, URL) that will be available to portal users requiring additional assistance logging into their account. This information can be accessed by clicking the Forgot Username link on the Forgot Password screen or clicking the "Did not get an email?" link after the portal user submits their username to initiate their password reset.</p> <p>Note: At least one field must be configured in order for the contact option to be available in the portal.</p>

Please note that enabling the Sugar portal will create a Customer Self-Service Portal Role and enable a Portal API user in Admin > User Management which must be left enabled in order for portal users to authenticate. The information viewable in the portal can be updated and restricted by Sugar users as allowed by team membership, user access type, and assigned roles. For more information on teams and roles, please refer to the [Team Management](#) and [Role Management](#) documentation in the Administration guide.

Please do not delete the Customer Self-Service Portal Role or the Portal API user as they are system-generated based on portal activation. If the portal role or user is accidentally deleted, then please disable and re-enable the Sugar Portal to

recreate them.

Note: Hiding a module (e.g. Knowledge Base) via Admin > Display Modules and Subpanels will not remove the module from the portal. You will need to disable access to the module via Admin > Role Management for the Customer Self-Service Portal Role in order to remove it from the portal. For more information on roles, refer to the [Role Management](#) documentation.

Theme Portal

The Sugar Portal Editor allows you to change the colors of the navigation bar, the line beneath the navigation bar, as well as the buttons/links in the Sugar portal to match your company's color scheme.

The theme menu allows you to configure the following elements on the portal page:

- **Border Color** : The border line beneath the navigation bar.
- **Navigation Bar** : The navigation bar at the top of the portal screen consisting of the module tabs and logomark.
- **Primary Button** : The buttons (e.g. Create, Save) on the portal page such as "Create"/"Save", as well as the links.

To change the color of one of the elements, click the text box to the right of the current color which will display a color picker tool. Use the slider in the color spectrum bar on the right to select the color group, and then choose the desired shade from the color chart on the left. The selected color will be shown below in the horizontal bar. Click anywhere on the Configure Portal Theme page to confirm your chosen color for the given element.

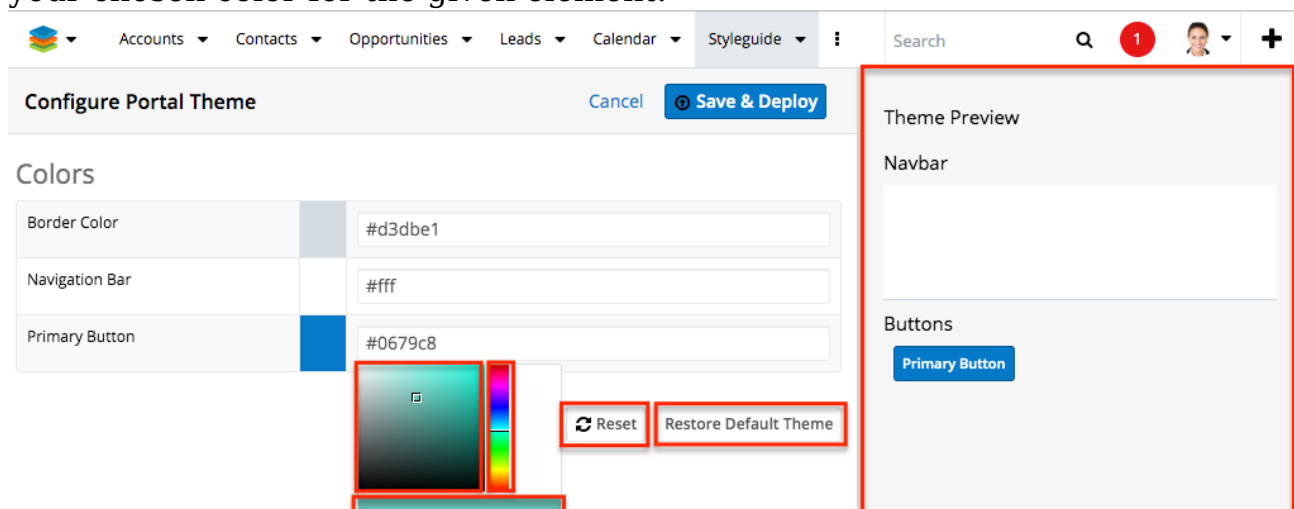

Note: If you know the HTML hexadecimal code for your company's colors, you can

manually enter this in the text box as well.

Once you have selected your color, the preview pane to the right will display how the elements will appear in the portal. Once you have chosen your desired theme colors, click "Save & Deploy" to push the changes to your portal.

If you do not like the color changes being made while editing, you can simply click the Reset button to return to your most recently saved color options. You can also click the Restore Default Theme button if you wish to restore the theme back to the default out-of-the-box colors.

Layouts

The Sugar Portal Editor also allows you to configure the [record view](#) and [list view](#) layouts for the Cases, Bugs, and Knowledge Base modules in the portal. You can also configure the Contacts record view layout to control what fields to display in the portal user's profile. Please note that both stock and custom fields that appear in Admin > Studio are available to add to the portal layouts.

Record View

The portal record view displays key record information including all relevant fields for the module (e.g. Knowledge Base) and the user's profile. The editor allows you to add a field to the Record View layout by dragging the field from the list of fields in the Toolbox to a "(filler)" location on the layout per your preference. You can also change the location of existing fields in the layout by dragging and dropping the field to a different location on the layout. To remove a field from the layout, simply drag and drop the field(s) from the layout to the trash bin in the Toolbox. Please note that changes to the Record View layout will also affect what fields appear when a portal user [previews](#) a record (e.g. knowledge base) in the portal. Once the layout is finalized, click "Save & Deploy" to preserve your changes and deploy it to the portal. You can also click "Save" if you wish to preserve the changes but not deploy the changes to the portal. For more information on editing the record view layout, refer to the [Studio](#) documentation.

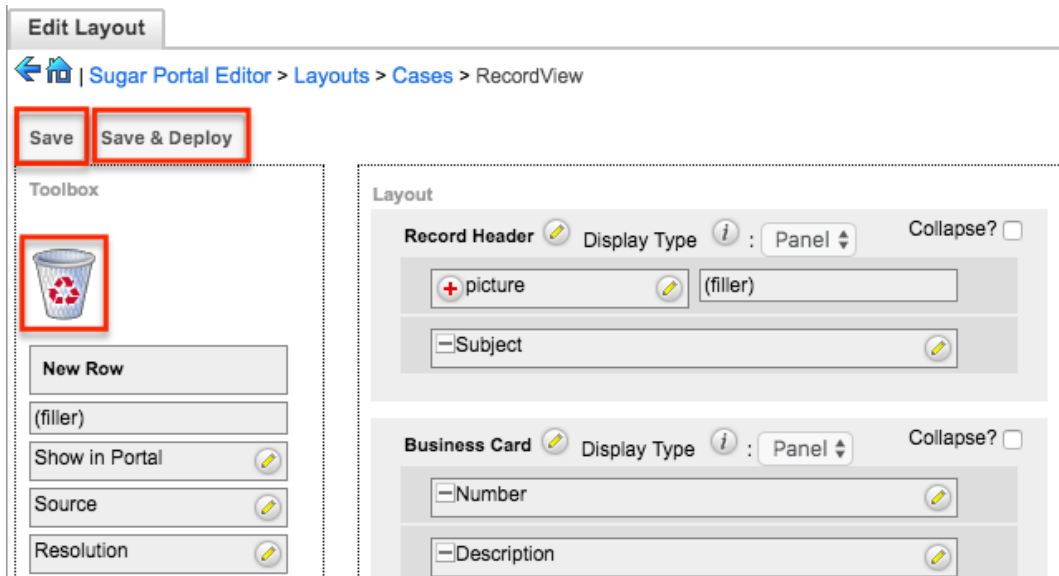

List View

The portal list view displays all records that meet the current search criteria in the Cases, Bugs, and/or Knowledge Base modules that the portal users can access. The editor allows you to drag and drop fields between the Default, Available, and Hidden columns as follows:

- **Default** : Drag fields into the Default column to display them in the default List View layout. To change the left-to-right order of the fields displayed on the list view (or right-to-left for users viewing an RTL language), drag and drop the fields up or down within the Default list.
- **Available** : Drag fields into the Available column to make them available for portal users to personalize their view of the list view layout without making them part of the default layout. Portal users will be able to click the Column Selection icon to the far right of the list view column headers to see the list of available fields.
- **Hidden** : Drag fields into the Hidden column to hide them from portal users in the module's list view.

You can also modify the label and width for a field by clicking the Pencil icon to the right of each field and entering the new field label and selecting the width (e.g. small, medium) of the field column in the list view.

Once the list view layout is finalized, click "Save & Deploy" to preserve your changes and deploy it to the portal. For more information on editing the list view layout, refer to the [Studio](#) documentation.

Edit Layout

← | Sugar Portal Editor > Layouts > Cases > ListView

Save & Deploy

Default	Available	Hidden
Num. [case_number]	[Drop Here]	Date Modified [date_modified]
Subject [name]		Source [source]
Status [status]		Assigned to [assigned_user_name]
Priority [priority]		Resolution [resolution]
Type [type]		Description [description]

Last Modified: 2019-12-05 15:47:53

Workflow Management

Overview

Sugar's Workflow functionality allows administrators to configure cause-and-effect type actions throughout Sugar and across multiple modules. Workflows can be used to update fields, send emails, or create records when certain conditions are met. Workflows are a great way to configure automated processes within Sugar so that users do not need to remember manual steps and instead can focus on their primary tasks and job responsibilities.

All workflow conditions are reached and checked for once a record is saved. Workflows can be configured to either start their process to perform the job the moment the save occurs, or they can be delayed for a given amount of time.

The following save events can trigger a workflow to fire:

Workflows can be viewed and configured by any System Administrator User. In addition, regular users with a role that provides Developer access will be able to access workflows for the module they have the rights to. For more information on Roles, please review the [Roles](#) documentation.

Note: The Workflow module is not available for Sugar Serve and Sugar Sell users. For more information on license types and the functionality available for each type, refer to the [User Management](#) documentation.

Workflow Fields

The Workflow module contains seven fields that will retain both functional and organizational purposes in Workflows. These fields cannot be edited or added to because of their functional purposes in the workflow process.

Field	Dropdown Options	Description
Applies To	<ul style="list-style-type: none"> • New and Updated Records • New Records Only • Updated Records Only 	Choose if this workflow is going to fire on all saves, when a new record is created, or when an existing record is updated
Description	(Text Area Field, no character limit)	A description of this workflow and its purpose
Execution Occurs	<ul style="list-style-type: none"> • When record saved • After time elapses 	Whether the workflow effects will occur once a record is saved, or if they will be re-checked and occur after a defined amount of time
Name	(Text field, limit of 50 characters)	Identifying name of the workflow
Processing Order	<ul style="list-style-type: none"> • Alerts then Actions • Actions then Alerts 	If your workflow is going to include both email alerts and workflow actions, select which of the two you would like to happen first
Status	<ul style="list-style-type: none"> • Active • Inactive 	When set to Inactive, the workflow will not process
Target Module	(Module List)	A list of all modules in Sugar that are compatible with workflows. Choose which module the primary conditions will be triggered from

Workflow Module Tab

The Workflow Definitions module tab is typically located on the navigation bar at the top your Sugar screen after navigating to Admin > Workflow Management. Click the tab to access the Workflows list view. You may also click the triangle in the Workflow Definitions tab to display the Actions and Recently Viewed menus. The Actions menu allows you to perform important actions within the module. The [Recently Viewed](#) menu displays the list of workflow definitions you last viewed in the module.

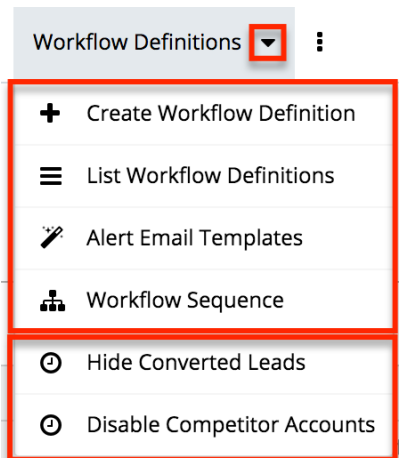

The Actions menu allows you to perform the following operations:

Menu Item	Description
Create Workflow Definition	Opens the edit view layout to create a new workflow
List Workflow Definitions	Opens the list view layout to search and display workflows
Alert Email Templates	Opens the Alert Template menu to allow you to create, view, and edit existing alert email templates
Workflow Sequence	Opens the Workflow Sequence menu to allow you to reorganize the processing order of your workflows for each module

Creating Workflows

Workflows are created by accessing the Admin menu, navigating to the Developer Tools section and then clicking on the link for Workflow Management.



Product and Quotes

Once on the Workflow Management module, you can create a new workflow or duplicate an existing one. The process of creating workflows contains four main sections. First, the workflow itself must be created. This creation process will include the name of the workflow, as well as the rest of the values for the fields listed in the [Workflow Fields](#) section of this documentation. After the workflow has been saved, the next step will be to configure the [Workflow Conditions](#), which defines what will cause the workflow to happen, or its triggers. Finally, the [Workflow Alerts](#) and [Workflow Actions](#) must be configured. These define what the workflow will do to Sugar records or what emails will be sent out after triggered.

Creating Via Workflow Module

The most common method of workflow creation is via the Create Workflow Definition option in the Workflow Management module. This opens up the edit view layout which allows you to enter in all the relevant information for the workflow.

Use the following steps to create a workflow via the Workflow Management module:

1. Navigate to Admin > Workflow Management.
2. Click the triangle in the Workflow Definitions tab to open the Actions menu and select "Create Workflow Definition".

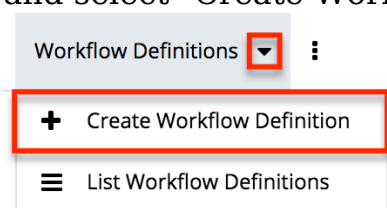

3. Enter appropriate values for the [fields](#) in the edit view layout. All required fields are marked with a red asterisk and must be completed prior to saving.
4. Once the necessary information is entered, click "Save".

Create

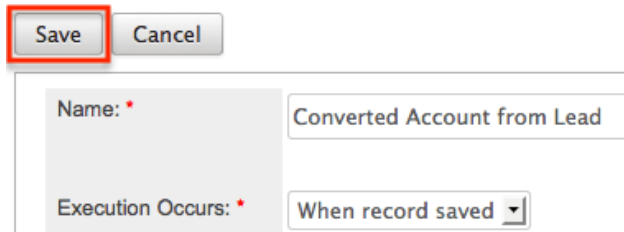

Save Cancel

Name: * Converted Account from Lead

Execution Occurs: * When record saved ▾

5. Define the conditions of the workflow that will trigger the workflow to process as described in [Creating Workflow Conditions](#).
6. Define what will happen when the workflow is processed as described in [Creating Workflow Alerts](#) and [Creating Workflow Actions](#).

Creating Via Duplication

You can also create a new workflow definition by duplicating an existing workflow record. The duplicate option is useful if the workflow you are creating has similar information, conditions, and alerts and actions to an existing workflow as all of these are copied over during the duplication process.

Use the following steps to create a workflow definition by duplicating an existing record:

1. Navigate to a workflow definition's detail view.
2. Click the Actions menu and select "Copy".

Lead Converted to Contact

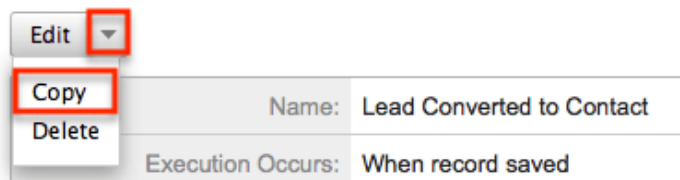

Edit ▾

Copy

Delete

Name: Lead Converted to Contact

Execution Occurs: When record saved

3. The displayed edit view is pre-populated with the original workflow's values. Update the necessary fields then click "Save".

Create

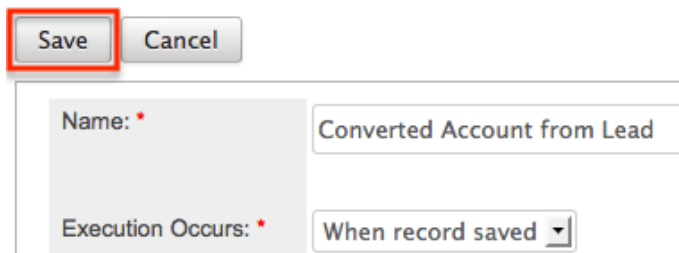

Save Cancel

Name: * Converted Account from Lead

Execution Occurs: * When record saved ▾

Creating Workflow Conditions

Workflow conditions are an essential function when creating workflows. Workflow Conditions define the "cause" side of workflow's cause and effect type functionality. At least one condition must exist for a workflow to trigger. If more than one conditions exist, they all must be fulfilled for the workflow to trigger.

Use the following steps to create a workflow condition:

1. Navigate to the detail view of the workflow.
2. Click "Create" on the Conditions subpanel to open a popup box with the different condition possibilities.

When these conditions are met:

Conditions

Create

Description:

3. Follow the prompts in the popup to create the different conditions, as described below. Once complete, click "Save" and the condition will be added to your workflow definition.
4. Repeat this process as necessary to add additional conditions.
5. After the condition has been created, it will appear in the [conditions subpanel](#).

Note: The available conditions will vary depending on the execution type ("When record saved" or "After time elapses") you have chosen for the workflow.

Creating "After Time Elapsed" Workflow Conditions

Before creating workflows with time-elapsed conditions, please take note of the following:

-
- The system's Process Workflow Tasks scheduler must be enabled and running as often as possible for time-elapsd workflows to work. For more information, please refer to the [Schedulers](#) documentation.
 - When a time-elapsd condition is used on a workflow definition, the Date Modified and Modified By fields will change on the records affected by the workflow's action(s). The Modified By user will be the admin user with ID = 1 (usually "Administrator") and the Date Modified will reflect the date and time that the action occurred in the system.
 - The time intervals (e.g. 0 hours, 4 hours) available when setting up time-elapsd conditions can be configured via Admin > Dropdown Editor. For more information on configuring the time intervals, please refer to the [Developer Tools](#) documentation.

The "After time elapsed" workflow condition options are different for the first condition and subsequent conditions. This is to ensure that your time-based condition is recorded. After that, you can set additional conditions to filter the records from which the workflows will fire.

When used as the first condition of a workflow, the "After time elapsed" options are as follows:

- **When a field in the target module changes to or from a specified value :** You will be asked to specify a specific field within the module, and its value. Then, you will select the amount of time after the change that, after this threshold, the workflow will fire.
- **Field does not change for a specified amount of time :** You will be asked to specify a specific field within the module and a timeframe. After the field changes, if it does not change again in the given timeframe, the workflow will fire.

When used as subsequent conditions of a workflow, the "After time elapsed" options are the two mentioned above as well as two additional options:

- **When a field in the target module contains a specified value :** This condition is used to filter records that should or should not be included in the workflow. You will be asked to specify a field and the value of the field, and if you want to include records where the field is a specific value, or if it is not a specific value. These conditions will vary by which field is chosen.
- **When the target module changes and a field in a related module contains a specified value :** This condition is used to filter records based on their related records. You will be asked to specify which relationship you would like the workflow to look at, and which field and value should or should not be used when triggering the workflow.

Creating "When Record Saves" Workflow Conditions

The "When record saves" workflow condition options are as follows:

- **When a field in the target module changes to or from a specified value :** This option can be used to specify both the new value of a specific field to trigger a workflow, and also what the previous value was. You will be asked to specify the specific field and the new value after save to use this condition. The previous value is not required.
- **When the target module changes :** This option will cause the workflow to trigger when any change to the record takes place.
- **When a field on the target module changes :** This option will cause the workflow to trigger when there is any change to a specific field, regardless of what the change is.
- **When a field in the target module contains a specified value :** This condition is used to filter records that should or should not be included in the workflow. You will be asked to specify a field and the value of the field, and if you want to include records where the field is a specific value, or if it is not a specific value. These conditions will vary by which field is chosen.
- **When the target module changes and a field in a related module contains a specified value :** This condition is used to filter records based on their related records. You will be asked to specify which relationship you would like to the workflow to look at, and which field and value should or should not be used when triggering the workflow.

Creating Workflow Alerts

Workflow alerts are one of the possible effects of workflow's cause and effect type functionality. These can be used with or without [workflow actions](#). Workflow alerts, when triggered by the workflow condition, will cause an email to be sent to a specified recipient. These recipients include Sugar users or individuals related to the target module. To create a workflow alert, follow the following steps:

1. Navigate to the detail view of the workflow.
2. Click "Create" on the Alerts subpanel, which will bring you to the alert setup page.

These operations will be performed:

Alerts

Create ▾

Details Type:

Event Description:

3. You will be presented with the following fields to populate.

Field	Description
Name	Choose a brief, descriptive name for this alert.

Alert Type	Defaults to "Email", which is the most common usage, but you can choose "Invite" if the alert is going to send an invitation for appointment-based modules.
Source Type	Choose "Normal message" to type a plain-text email message in the Alert Text field, or choose "Custom Template" to select and use a Workflow Alert Template .
Alert Text	Enter text that will be sent to the alert's recipients as a simple email message without formatting or variables. Note: This field is shown only when the Source Type field contains "Normal message".
Custom Template	Select from your available Workflow Alert Templates for this alert's target module. Note: This field is shown only when the Source Type field contains "Custom Template".

4. Enter necessary values for all fields and click Save.

The screenshot shows a form with the following elements:

- Buttons: "Save" (highlighted with a red box) and "Cancel".
- Field "Name: *": Text input containing "New Customer Alert Email".
- Field "Alert Type": Dropdown menu with "Email" selected.
- Field "Source Type": Dropdown menu with "Custom Template" selected.
- Field "Custom Template": Dropdown menu with "New Account Template" selected.
- Text: "* Indicates" in the top right corner.

5. On the next screen, click "Create" on the "Alert Recipient List" subpanel to choose your recipients.

New Customer Alert Email

Name:	New C
Alert Type:	Email

Alert Recipient List

Alert Recipients:

Note: The only options that will send to someone other than a Sugar user are "Recipient associated with the target module" and "Recipient associated with a related module".

- Pick the recipients, select any blue hyperlink text to define any variables, such as who a specified user is, or if the recipient should be sent the email as a "To", "CC", or "BCC" recipient, and then click "Save" to continue.

User who creat

User who last n

User who is as

User who was assigned the record

A user associated with the target module
[User](#) who is assigned the record using address [type](#)

User's Manager
Please Select User

- Repeat steps 5 and 6 as need be to add additional recipients for this workflow alert.
- Click the hyperlink for "Send alert to the following recipient" to make any changes, remove any errant recipients with the "Remove" button on the corresponding row, or the "Edit" button on the top left if you need to change any configurations. Once complete, click "Return to Workflow Definition".

New Customer Alert Email

Edit	Delete	Return to Workflow Definition	
Name:	New Customer Alert Email	Source Type:	Custom Template
Alert Type:	Email		

Alert Recipient List

Create
Alert Recipients:
Send alert to the following recipient: A user associated with the target module - remove

9. After the alert has been created, it will appear in the [Alert Subpanels](#).

Creating Workflow Actions

Workflow actions are one of the possible effects of workflow's cause and effect type functionality. These can be used with or without [Workflow Alerts](#). Workflow actions, when triggered by the workflow condition, will cause either updates to existing records or creation of new records. To create a workflow action, follow the following steps:

1. Navigate to the detail view of the workflow that you are working on
2. Click "Create" on the Actions subpanel to open a popup box with the different action possibilities

Actions
Create
Details Type: Event Description:

3. Follow the prompts in the popup to create the different actions, as described in [Workflow Actions](#). Once complete, click "Save" and the action will be added to your workflow definition.
4. Repeat this process as necessary to add additional actions.
5. After that action has been created, it will appear in the [Actions Subpanel](#).

Workflow Action Types

There are four options for actions that are available. These options can make updates to the module your workflow is tied to, or a module related to this target module. The options can also create records in related modules or modules related to related modules. The options are as follows:

- **Update fields in the target module** : You will be given the option to select one or more fields within the target module of the workflow, and what the new value or values should be.
- **Update fields in a related module** : You will first be given the option to choose which related module to the target module you would like to update. After selecting the related module, you will select one or more fields within the related module to update, and what the new value or values should be.
- **Create a record in a module associated with target module** : You will be given the option to choose a related module to your target module. This action will create a new record in the related module, such as creating a new call related to an account, where Accounts is the target module. After selecting the module, you will be given the option to populate any or all fields with the related module. Any required fields will be marked with a red asterisk.
- **Create a record associated with a module related to the target module** : This action will take a record, or all records, related to your target module, and create a related record to this middle module. When creating these actions, you are asked to select the related module to your target module, and then select that module's related module where the new record is going to be created. For example, if your workflow's target module is Contacts, the following screenshot shows how a call will be created and related to the contact's related Opportunity.

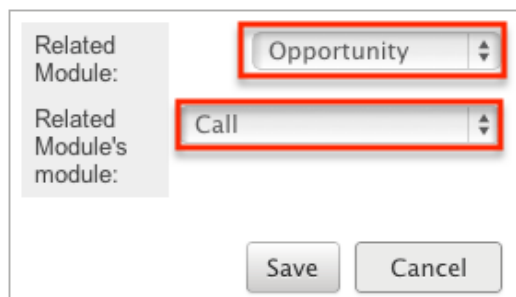
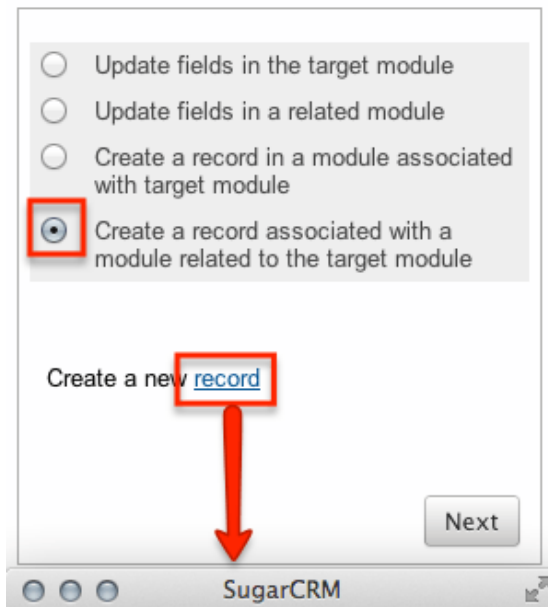

On the next screen, after selecting your modules, you will select one or more fields within the related module to update, and what the new value or values should be. Clicking on the "Advanced Search" button at the bottom of this window will allow you to select if the workflow is specific for all related records (Opportunities), or if the related record should be filtered at all.

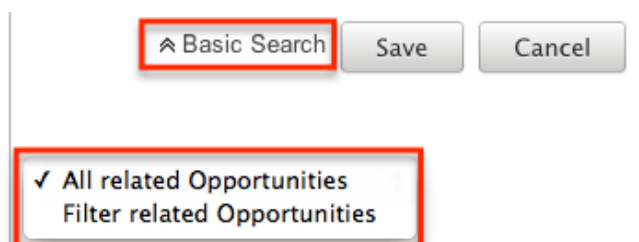

The "Advanced Search" function also contains special functions for specific field types:

- **Assigned User** : Allows you to configure the action to set the assigned user to be either the actual user or the user's manager who either is currently assigned to the triggered record, the one who most recently updated it, the one who created it, or is the one saving the record.
- **Team ID** : Allows you to configure the action to set the team to be the default team of the user who triggered the workflow or, if it is

updating a related record, to match the primary team of the triggered record.

- **Dropdown Fields** : Allows you to configure the action to sequentially move the dropdown option forward or backward in the order in which it appears in the dropdown list.

Viewing Workflows

There are various options available for viewing workflow records in Sugar including via Workflow Definitions list view, Workflow Definitions detail view, and the Workflow Definitions Last Viewed menu. Each method will provide varying degrees of detail and insight into the workflow.

Viewing Via List View

The Workflow Definitions list view displays all records meeting the current search criteria. To access the list view, simply click the Workflow Definitions module tab, which is made available by navigating to Admin > Workflow Management. While list view shows key workflow fields, you can click the workflow definition's name to open the record in detail view. For more information on viewing workflows via list view, please refer to the [Workflows List View](#) section of this documentation.

Viewing Via Detail View

The Workflow Definitions detail view displays thorough workflow information including all workflow fields followed by subpanels showing the Conditions, Alerts, and Actions that process the workflow. The detail view can be reached by clicking a workflow definition's link from the Workflow Definitions list view. For more information on viewing workflows via detail view, please refer to the [Workflow Detail View](#) section of this documentation.

Viewing Via Recently Viewed

As you work, Sugar will keep track of which workflows you have recently viewed. Click the Actions menu in the [Workflow Definitions module tab](#) to see a list of your most recently viewed workflows and click each name to open the workflow definition in detail view.

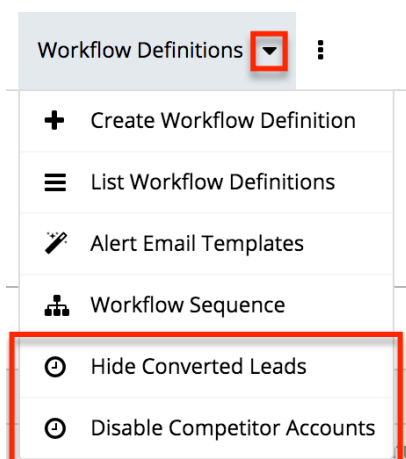

Searching Workflows

The Workflow Definitions list view includes a Basic and Advanced Search to help you locate records easily and effectively. Once the search is performed, the relevant results will be displayed in the Workflows list view below. Please note that Sugar automatically appends the wildcard character (%) to the end of your search phrase. This allows the system to retrieve all records that start with the keyword entered in the search. If you would like to broaden the search, you can use the wildcard at the beginning of your text as well (e.g. %created). This will pull up any workflow that has the word "created" in the name, regardless of how it starts or ends.

For more information on using the various search methods as well as how wildcards are used in the different methods, please refer to the [Search](#) documentation.

Basic Search

Basic search offers a simplified search experience allowing you to search for just the name of the workflow. From the Basic Search panel, you can click "Advanced Search" to access additional search functionality as needed.

The buttons and checkboxes available in Basic Search panel have the following functions:

- **Search** : Click the Search button or press your Return/Enter key to perform the search.
- **Clear** : Click the Clear button to clear criteria from the Name field.

Workflow Definitions

Name [Advanced Search](#)

When you run a search, Sugar will return records matching all (as opposed to any) of the fields for which you have given a value. Once the search is complete, the relevant results will populate in the [list view](#) beneath the search panel. To see all workflow definitions, simply click "Clear" and then "Search" to perform a blank search with no filters.

Advanced Search

Advanced Search offers a more in-depth search experience than Basic Search including additional fields, layout options, and saved search capability. From the Advanced search panel, you can click "Basic Search" for simplified searching.

The buttons and dropdowns available in Advanced Search have the following functions:

- **Search** : Click the Search button or press your Return/Enter key to perform the search.
- **Clear** : Click the Clear button to clear all criteria from the searchable fields.
- **Layout Options** : Use the expandable Layout Options section to configure your list view. For more information, please refer to the [Layout Options](#) section of the Search documentation.
- **Saved Searches** : Save, recall, update, and delete searches which you use often. For more information, please refer to the [Saved Search](#) section of the Search documentation.

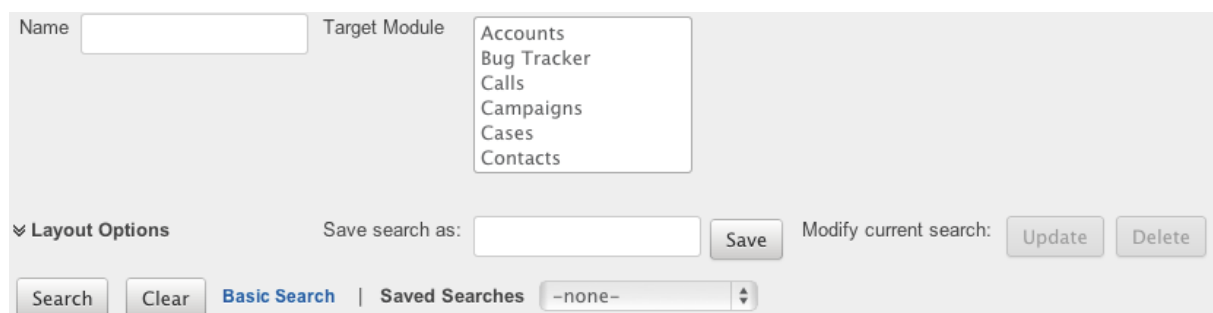

Name Target Module
Accounts
Bug Tracker
Calls
Campaigns
Cases
Contacts

Layout Options Save search as: Modify current search:

[Basic Search](#) | Saved Searches

When you run a search, Sugar will return records matching all (as opposed to any) of the fields for which you have given a value. For example, if you select the Target Module as "Accounts" or "Contacts" and enter in the word "Created" for the Name search, Sugar will only return workflow definitions with a matching name from the

Accounts or Contacts modules. Once the search completes, the relevant results will populate in the [list view](#) beneath the search panel. To see all workflow definitions, simply click "Clear" and then "Search" to perform a blank search with no filters.

Workflows List View

The Workflows list view displays all workflow definitions meeting the current search criteria. You can view the basic details of each workflow within the field columns. The list view also allows for records to be edited or deleted as need be.

Pagination

List view displays the current search results broken into pages that you can scroll through rather than displaying potentially thousands of rows at once. To the right just below the search panel you can see which records of the total results set are currently being displayed. The two single-arrow Next and Previous buttons can be used to scroll through the records page-by-page. The two double-arrow First Page and Last Page buttons allow you to skip to the beginning or the end of your current results.

By default, Sugar displays 20 records per list view page, but the number of records displayed can be changed via Admin > System Settings. For more information on changing the number of displayed records, please refer to the [System](#) documentation.

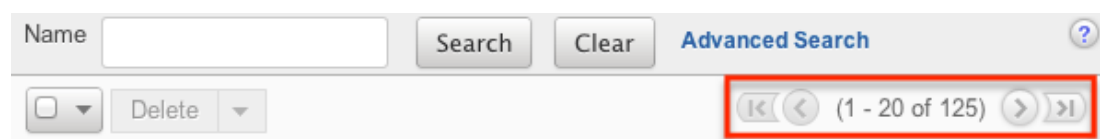

Checkbox Selection

You can delete workflow definitions directly from the list view by first selecting the desired records. To select individual workflows on the Workflow Definitions list view, mark the checkbox on the left of each row. To select or deselect multiple workflow definitions on the list view, use the options in the checkbox dropdown menu:

- **Select This Page** : Selects all records shown on the current page of workflow results.
- **Select All** : Selects all records in the current search results across all pages of workflow results.
- **Deselect All** : Deselects all records that are currently selected.

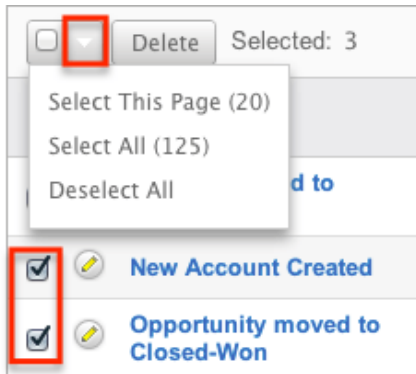

Column Sorting

List view provides the ability to sort all of the current search results by a field column in either ascending or descending order. To sort by a field or switch the sort direction, click the column header noting that the fields which allow sorting will have a pair of arrows. The list view may be sorted by only one column at a time. You can also set a default order-by column using the layout options in Advanced Search. For more information on setting a default column sort, please refer to the [Layout Options](#) section of the Search documentation.

Name	Execution Occurs	Status	Target Module
New Account Created	When record saved	Active	Accounts

Workflow Detail View

The Workflow Definition detail view displays thorough workflow information including all workflow fields. You will also see the Conditions, Alerts, and Actionssubpanels beneath the workflow fields. The detail view can be reached by clicking a workflow record's link from the Workflow Definitions list view or from the recently viewed menu.

Actions Menu

The Actions menu on the top left of each workflow definition's detail view allows you to perform various actions on the current record. The action items can be configured to be displayed as separate buttons instead of a dropdown menu via Admin > System Settings. For more information on configuring the actions menu, please refer to the [System](#) documentation in the Administration guide.

New Account Created

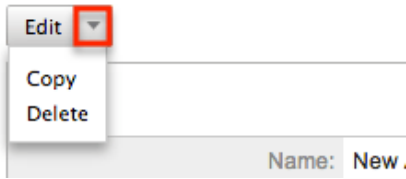

The Options in the Actions menu allow you to perform the following operations:

Menu Item	Description
Edit	Edit this workflow definition
Copy	Duplicate this workflow definition
Delete	Delete this workflow definition

Next or Previous Record

On the upper right of the Workflow Definitions detail view, there are four buttons that allow you to page through each workflow in the Workflow Definition list view's current search results. Clicking the Previous button displays the previous workflow of the current search results while clicking the Next button displays the next workflow of the current search results. The two double-arrow First Page and Last Page buttons allow you to skip to the first or the last workflow of your current results. The text in between shows which workflow result you are currently viewing within the total number of current results.

New Account Created

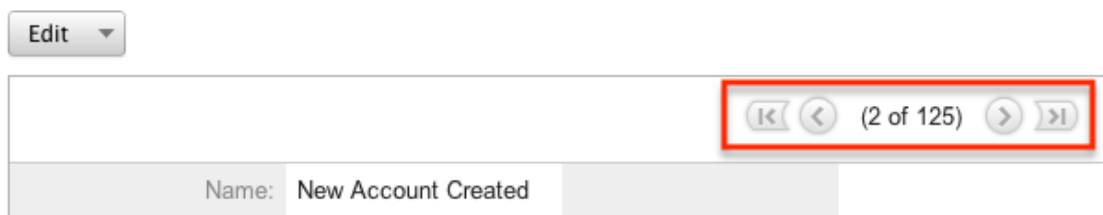

Conditions Subpanel

The Workflow Conditions subpanel allows you to create additional conditions for your workflow and also lets you view and modify the existing ones. The subpanel shows a Description and a Value for each condition. The Description is an automatically generated, brief explanation of the condition. The Value shows what

field or fields are covered in the condition, if not expressly stated in the description. The Conditions subpanel allows the following operations to be performed.

- To view the details or edit a condition, either click the condition's description in the subpanel or click the edit button to from the far right of the record's row to open the condition popup.
- To create a new workflow condition, choose "Create" from above the subpanel, then follow the steps supplied in the [Creating Workflow Conditions](#) section of this documentation.
- To delete a condition on this workflow, choose "Remove" from the far right of the record's row.



Alert Subpanels

The Workflow Alert subpanel allows you to create additional alerts for your workflow and also lets you view and modify the existing ones. The subpanel displays the "Detail"s, "Type", and "Event Description" for each condition. After an alert has been created, there is also a column for Recipients. The "Event Description" is automatically generated and provides a brief explanation of the alert with the name of the Alert record and what template (if applicable) is being sent to the recipients. The Alerts subpanel allows the following operations to be performed.

- To view or edit an alert, either click the alert's event description or click "Edit" on the far right of the row to open the alert's edit view.
- To view the recipients of the alert, click "Show" from the far left of the record's row. Click "Hide" to collapse the drawer highlighting the recipients
- To edit or add recipients of the workflow alert, click "Recipients". This button will also open the alert's detail view.
- To create a new workflow alert, choose "Create" from above the subpanel, then follow the steps supplied in the [Creating Workflow Alerts](#) section of this documentation.
- To delete an alert on this workflow, choose "Remove" from the far right of the record's row.

Alerts

Alerts

Create

Details	Type:	Event Description:		
Hide	Alerts	Recipients	Send <i>New Account Created</i> using a Custom Template: <i>New Account Template</i>	edit remove

- A specified user Administrator

Actions Subpanel

The Workflow Actions subpanel allows you to create additional actions for your workflow and also lets you view and modify the existing ones. The subpanel shows a Details, Type and an Event Description for each condition. The Event Description is an automatically generated, brief explanation of the action that will be performed by the workflow. The Conditions subpanel allows the following operations to be performed.

- To view the details or edit a condition, either click the condition's description in the subpanel or click the edit button to from the far right of the record's row to open the condition popup.
- To view the actions that will be performed, click "Show" from the far left of the record's row. Click "Hide" to collapse the drawer highlighting the actions.
- To create a new workflow action, choose "Create" from above the subpanel, then follow the steps supplied in the [Creating Workflow Actions](#) section of this documentation.
- To delete an action on this workflow, choose "Remove" from the far right of the record's row.

Actions

Actions

Create

Details	Type:	Event Description:		
Hide	Actions	Update fields in the target module	edit	remove

- Set account_type as Customer

Editing Workflows

Workflows may be edited at any time to update or add information to the definition. You can make changes to existing workflow definitions via the

Workflows edit view. Edit view is available within the Workflows module and includes all of the Workflow fields. It can be accessed either via the detail view or list view. Please note that Conditions, Alerts, and Actions are not edited through the Workflow edit view.

Note: After a workflow has been created, the fields "Execution Occurs" and "Target Module" cannot be edited

Editing Via Detail View

You can edit workflows via the [detail view](#) by clicking the Edit button on the upper left of the page. Once the edit view layout is open, update the necessary fields, then click "Save" to preserve the changes made.

New Account Created

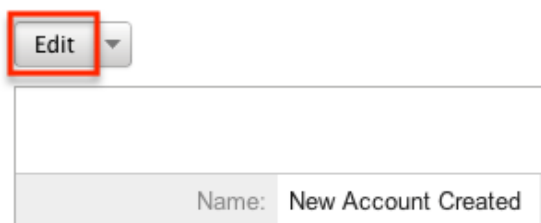

Editing Via List View

You can edit workflows via the [list view](#) by clicking the Pencil icon to the left of each workflow's name. The page will navigate to the edit view. Update the necessary fields, then click "Save" to preserve the changes. After saving, you will be brought to the detail view of the workflow.

	Name	Execution Occurs	Status	Target Module
<input type="checkbox"/>	 New Account Created	When record saved	Active	Accounts

Deleting Workflows

If a workflow definition is invalid or should no longer appear in your organization's Sugar instance, it may be deleted from either the Workflow Definitions detail view or list view. Deleting via the detail view allows you to delete a single record while the list view allows for mass deleting multiple records at once. Deleting the workflow definition will also remove the conditions, actions, and alerts to stop workflows from firing.

Deleting Via Detail View

Use the following steps to delete a workflow definition's detail view:

1. Navigate to a workflow definition's detail view.
2. Select "Delete" from the Actions menu.

New Account Created



3. A pop-up message will display asking for confirmation. Click "Ok" to proceed.

Mass Deleting Via List View

Use the following steps to delete one or more workflows via the list view:

1. Navigate to the Workflow Definitions list view via Admin > Workflow Management.
2. Use the [Basic](#) or [Advanced Search](#) to find the Workflow Definitions you wish to delete.
3. Select the desired records individually or using the [checkbox dropdown's](#) options.
4. Choose "Delete" from the Actions menu.

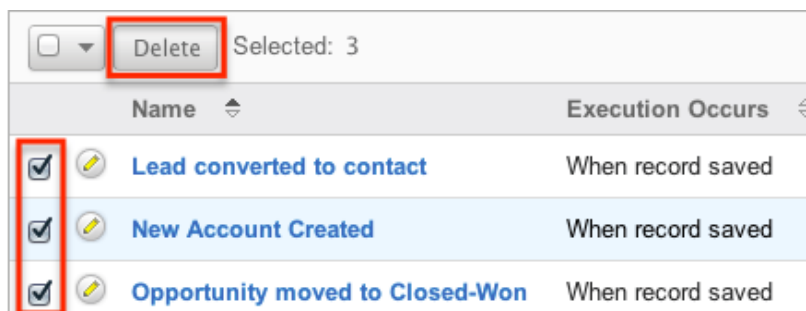

5. A pop-up message will display asking for confirmation. Click "Ok" to proceed.

Due to PHP memory limitations on the server, there may be occasions when the application times out while deleting a large number of workflow definitions. If you encounter an error when performing this action, we recommend selecting the records in smaller batches.

Workflow Alert Templates

When sending a workflow alert, you have the option of sending either a "Normal Message" which will be just a simple, plain text alert, or utilizing a workflow template. Templates have the option to use full HTML editing, to include formatting changes, colors, variables to include data from fields in Sugar, and more.

Alert Template Fields

The Workflow Templates functionality contains several fields that will retain both functional and organizational purposes in Workflows. These fields cannot be edited or added to because of their functional purposes in the workflow process.

Field	Description
Body	This is where you can design your email template using the WYSIWYG (What you See Is What You Get) editor. Click the "Alt Text" checkbox to edit the plain text version of this email. The entry into this box is what will actually be sent to the recipients of the email.
Description	A short explanation of the template and what it is used for.
Field List	Used to select which field from the given module will be inserting into the Variable Insert field to eventually be inserted into the template, which can be changed by updating the Related Module dropdown field.
From Address	What sender's email address will be shown on the email when received by the recipient. Note: Mail servers have the functionality to override this setting meaning the email address will show as the one that actually sends this, defined in Admin > System Email Settings. Please review the Emails documentation for more information.
From Name	What sender's name will be shown on

	the email when received by the recipient.
Name	Identifying name of the template.
Related Module	List of modules related to the Target Module, which will change the Field List and, therefore, change the fields that can be used for variables in the email.
Subject	The subject line of the email which will show for the recipients.
Target Module	Selected when creating the template and a non-editable field, this will cause the template show when using the template for workflows made to the corresponding module.
Type	Will only show as workflow, but will vary when making other template types to include Email and Campaign.
Value Type	Select "New Value" or "Old Value" if the variable will be changing on the workflow to determine if the variable should include the value of the field before or after the record is saved.
Variable Insert	This field will build the variable for you based on the Target Module, Related Module, Field List, and Value Type fields.

Creating Alert Templates

Alert Templates are created only via the Workflow module. Alert templates can be created either directly from the workflows module via the Alert Templates page, or via duplication. The Target Module is defined during the creation process, and then a full edit view layout opens including all fields that will be necessary to create the template.

Creating Alert Templates Via Workflows Module

The most common method of template creation is via the Alert Email Templates option in the Workflow Definitions module tab. This will open the edit view layout allowing you to configure the template to your specifications.

Use the following steps to create the template via Workflow Management:

1. Navigate to Admin > Workflow Management.
2. Click the triangle in the Workflow Definitions tab and select "Alert Email Templates".

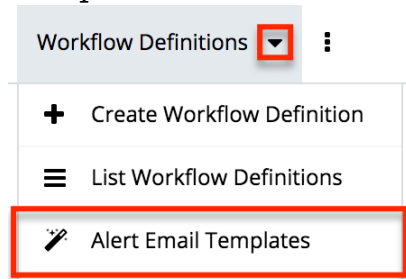

3. Select the module you wish to create the alert template for then click "Create".

Alert Templates

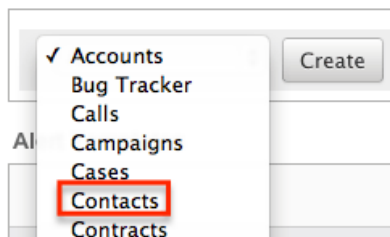

4. Enter appropriate values for the following fields below. Required fields are marked with a red asterisk and must be completed prior to saving.
 - **Name** : Enter a name for the email template.
 - **Type** : Leave as "Workflow".
 - **From Name** : The name that the email recipient will see as the sender.
 - **From Address** : The email address that the email recipient will see as the sender.
Note: This may be overwritten by your mail server configured in Admin > System [Email Settings](#).
 - **Description** : Enter a description or other information about the template.
 - **Related Module** : To insert a field from a record related to the target module, select the related module.
 - **Subject** : Enter the subject of the email that will be sent.
 - **Body** : Enter the body of the emails that will be sent.
 - **Attachments** : Click the "Choose File" button to open a file selection window from your browser and attach a file. Click the Sugar Document button to attach a file from the sugar database.
5. Populate the template body that will be sent to the email recipients. [Insert variables](#) as necessary for your workflows.
6. Using the TinyMCE functions, add simple formatting to your email's content. For more advanced customization you can click the HTML button

in the top left to access and edit the generated HTML code. For more information on using TinyMCE, please refer to the [User Interface](#) documentation.

Note: If images or advanced CSS are required in your email template, it is highly recommended to host the images or CSS file on a publicly available hosting service and link to it in the email template.

7. Once the necessary information is entered, click "Save" to preserve your changes to the email template.

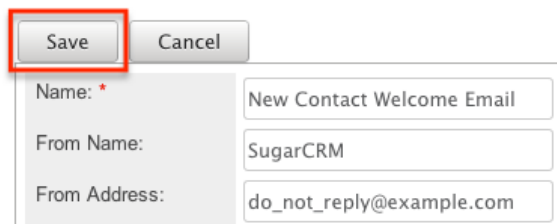

A screenshot of an email template edit form. At the top left, there are two buttons: "Save" and "Cancel". The "Save" button is highlighted with a red rectangular box. Below the buttons, there are three input fields: "Name: *" with the value "New Contact Welcome Email", "From Name:" with the value "SugarCRM", and "From Address:" with the value "do_not_reply@example.com".

Creating Alert Templates Via Duplication

You can also create a new template by duplicating an existing template. The duplicate option is useful if the template you are creating has similar information to an existing template.

Use the following steps to create a template by duplicating an existing template:

1. Navigate to an existing template's detail view.
2. Click the action option for "Copy".

New Contact Welcome Message

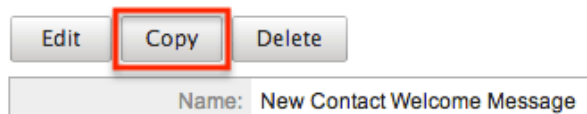

A screenshot of a template detail view. At the top, there are three buttons: "Edit", "Copy", and "Delete". The "Copy" button is highlighted with a red rectangular box. Below the buttons, there is a label "Name:" followed by the value "New Contact Welcome Message".

3. The displayed edit view is pre-populated with the original template's values. Update the necessary fields then click "Save".

New Contact Welcome Email

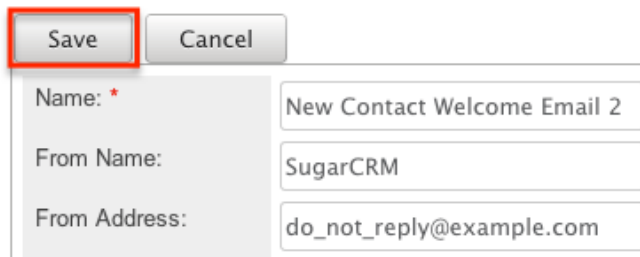

Save Cancel

Name: * New Contact Welcome Email 2

From Name: SugarCRM

From Address: do_not_reply@example.com

Inserting Variables

When constructing the subject and body of your email, Sugar allows you to insert variables, or placeholders, into the template that will be populated with the record's information for that variable. The variables allow you to insert data from fields within the record that triggered the workflow and its related records into your template. Use the following steps to insert a variable for the recipient's first name into the template:

1. Click to place your cursor on the location in the subject or body where the recipient's first name should appear.

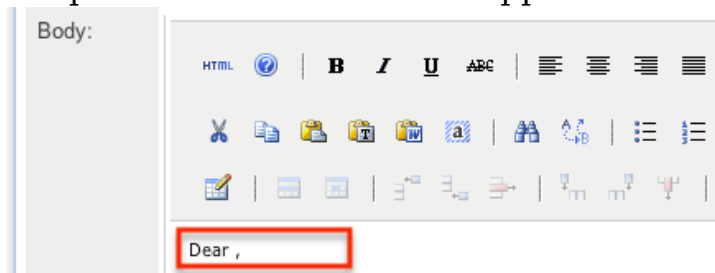

Body:

HTML | B I U ABC | [List Icons]

Dear ,

2. Set the variable dropdown to the desired field from the workflow's target module. For our example, select "First Name".

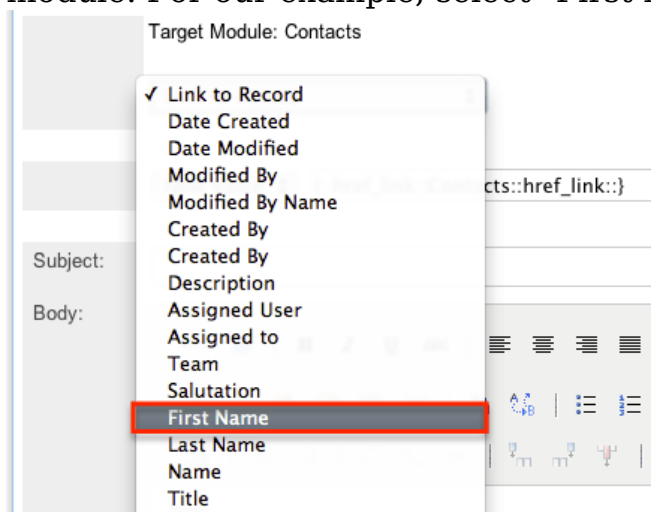

Target Module: Contacts

- ✓ Link to Record
- Date Created
- Date Modified
- Modified By
- Modified By Name
- Created By
- Created By
- Description
- Assigned User
- Assigned to
- Team
- Salutation
- First Name**
- Last Name
- Name
- Title

Body:

3. Choose between "New Value" and "Old Value" in the value dropdown field.

This will determine if the value of the given variable shown on the template will be the value of the field in question before or after the workflow fired. This functionality is especially helpful if you are showing a change between two values, such as an opportunity moving from new ("Old Value") to closed-won ("New Value"). "New Value" is the default option for this list.

4. Click "Insert" to insert the generated variable name to your subject or body at your cursor's location.

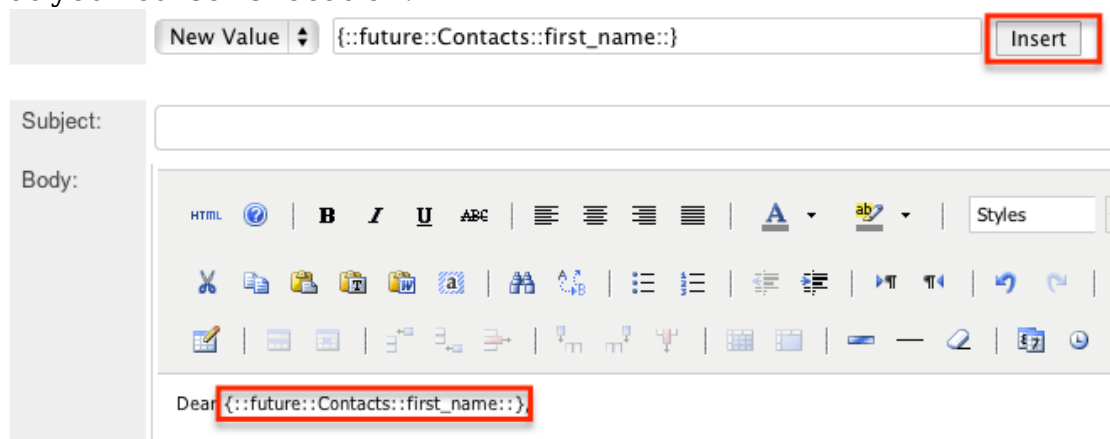

Note: You can click "Alt Text" at the bottom of the page to have the plain text option send differently than the HTML text.

Viewing Alert Templates

There are various options available for viewing workflow templates in Sugar including via Workflow Templates list view, Workflow Templates detail view, and from the Emails module.

Viewing Alert Templates Via List View

The Workflow Templates list view displays all workflow templates and key fields about each template. To access the list view, simply navigate to the Workflow Management section of the Admin menu and select "Alert Email Templates" from the Workflow Definitions module tab. Use the Alert Templates list view for the following functions:

- To open the record in detail view, click the template's name
- To re-sort the list view results one column at a time, click the column header, and the columns will sort alphabetically or chronologically
- Use the arrows in the top right side of the list view navigate through the pages of your templates, or skip to the first or last page using the double arrow buttons
- To delete a template, click "Remove" from the far right of the

corresponding template's row

Viewing Alert Templates Via Detail View

The Alert Templates detail view displays thorough alert template information including all template fields and a preview of the workflow template that recipients will see after it is sent. The detail view can be reached by clicking a template's link from the Alert Templates list view.

While viewing the detail view, the preview of the email template is shown as the last field option. You can also click the "Alt Text" checkbox to see how this email will look when the recipient views it as plain text.

Viewing Alert Templates Via Emails Module

The Emails module contains all of the email templates in Sugar. Alert Templates can be accessed via Emails, in addition to accessing via Workflow Management. To access alert templates via Emails, simply select the View Email Templates option from the [Emails](#) module tab.

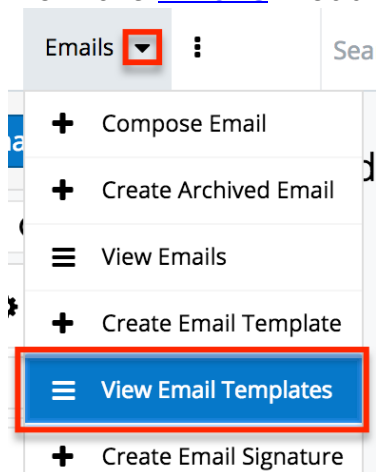

This will bring you to the [Email Templates list view](#) where you can select which template you would like to view. For more information on navigating the Emails module, please review the [Emails](#) module section of the Application Guide.

Editing Alert Templates

Alert Templates may be edited at any time to update or add information to the template. You can make changes to existing templates via the Alert Templates edit view. Edit view is accessible via the Alert Templates detail view. You can edit alert templates via the [detail view](#) by clicking the Edit button on the upper left of the

page. Once the edit view layout is open, update the necessary fields, then click "Save" to preserve the changes made.

New Contact Welcome Message

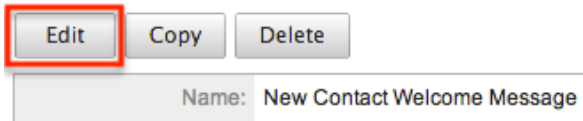

Deleting Alert Templates

If an alert template is invalid or should no longer appear in your organization's Sugar instance, it may be deleted from either the Alert Templates detail view or list view. Deleting alert templates will not delete any workflows using them. If a workflow is utilizing a template which you are deleting, it is recommended that the workflow be updated to include a new template on the alert.

To delete a template from the template's detail use the following steps:

1. Navigate to the Alert Templates detail view.
2. Click the Delete button.

New Contact Welcome Message

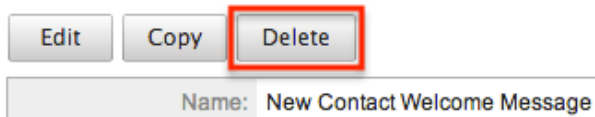

3. A pop-up message will display asking for confirmation. Click "Ok" to proceed.

To delete a template from the list view, use the following steps:

1. Navigate to the Alert Templates list view.
2. Select the "Remove" button on the row of the template you would like to delete.

Name ⇅	Base Module: ⇅	Description ⇅	Last Modified ⇅	
New contact welcome email	Contacts	Use this template for the new contact workflow	03/20/2013	

3. A pop-up message will display asking for confirmation. Click "Ok" to proceed.

Time Intervals for Time Elapsed Workflows

Time elapsed workflows trigger after a specified amount of time has passed from when the record was saved. Users with administrator or developer access have the ability to add new time intervals to the dropdown list ("tselect_type_dom") used for time elapsed workflows. The time interval dropdown list can be viewed and edited via Admin > Dropdown Editor. For more information on Dropdown Editor, please refer to the [Developer Tools](#) documentation.

By default, the time intervals are:

4 days 5 days 1 week 2 weeks 3 weeks







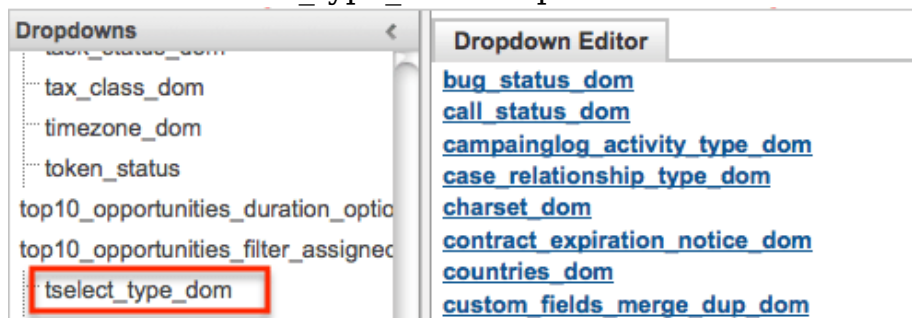

0 hours	3 days	30 days
4 hours	60 days	
8 hours	90 days	
12 hours	120 days	
1 day	150 days	
2 days	180 days	

The following steps cover adding a 1 hour time interval to the dropdown list via Dropdown Editor as an example:

1. Navigate to Admin > Dropdown Editor.
2. Locate the tselect_type_dom dropdown list and click to view the details.



3. Enter in an item name (e.g. 3600) and display label (e.g. 1 hours) into the corresponding fields below the existing item list.
 - Please note that the Item Name field must be in seconds equaling to the hours, days, weeks you wish to add.

• 7776000 [90 days]	 
• 10368000 [120 days]	 
• 12960000 [150 days]	 
• 15552000 [180 days]	 

Item Name: Display Label:

4. Click "Add" to add the new value to the dropdown list.
 - **Note:** The value will be added to the end of the list, but you can drag and drop the item to the top of the list if you wish. For more information on how to reorder and position values in the dropdown list, please refer to the [Developer Tools](#) documentation.

Dropdown Editor

Name: tselect_type_dom
Language:

List Items:
Item Name[Display Label]

• 0 [0 hours]
• 3600 [1 hours]
• 14440 [4 hours]

5. Once the item has been added and placed in the correct position, click "Save" to preserve the change.

The newly added time interval will now appear in the corresponding dropdown list when creating the condition for a time elapsed workflow.

Workflow Sequence

When a record is saved within a module, Sugar will check all workflows for that module to see if they need to process and perform any actions or send any alerts. Sugar processes each of the workflows in a sequential order, one after another. By default this order is determined as the order in which the workflow definitions were created; the oldest workflow fires first, moving up to the newest. This order, however, can be reorganized using the Workflow Sequence menu.

Workflow Sequence can be accessed through the following process:

1. Navigate to Admin > Workflow Management.
2. On the Workflow Definitions module tab, select "Workflow Sequence".

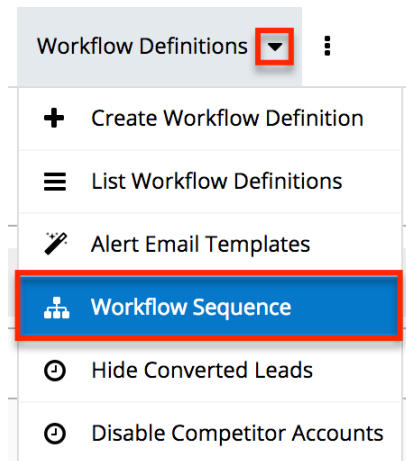

3. Select the module you would like to reorganize from the dropdown menu and click "Select".

Workflow Sequence

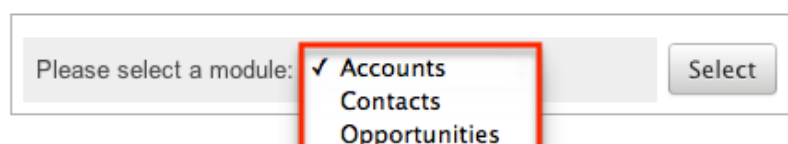

This process will produce a list view with all of the workflows for the particular selected module. The list view will show three columns containing details from the [workflow fields](#), as well as a fourth column for "Process Order".

Workflow Sequence: Accounts

Name	Execution Occurs:	Status	Process Order:
New Account Created	When record saved	Active	↑ up ↓ dn

The Process Order column is used to reorganize the workflows into their correct processing order. The Up button will move the workflow up one rung in the process, whereas the Dn button will lower it in the sequence. The order of the workflow process for this module is determined on this menu, starting at the top and working its way down.

Last Modified: 2020-02-03 21:44:43

Products and Quotes

Overview

The Products and Quotes section of the Admin panel enables you to define products and product details that are used in the [Quoted Line Items](#), [Quotes](#), and [Revenue Line Items](#) modules. The Products and Quotes panel provides access to the following administrative modules:

Module	Description
Product Catalog	List of products sold by your organization; used as a template for the Quoted Line Items and Revenue Line Items modules
Product Categories	The categories by which products are organized in the Product Catalog
Product Types	The Type dropdown list in the Product Catalog
Quotes Configuration	Configure which fields appear in the quotes worksheet while building quotes
Manufacturers	The Manufacturer Name dropdown list in the Product Catalog
Shipping Providers	The Shipping Provider dropdown list in quotes
Tax Rates	The Tax Rate dropdown list in quotes

This documentation will cover information and actions specific to the above module. For instructions concerning views and actions which are common across most Sugar modules, such as creating, editing, and deleting records, please refer to the [Working With Records](#) section of this page.

Please note that only administrators or users with developer-level role access have the ability to control the configurations within this page.

Note: The Quotes Configuration, Shipping Providers, and Tax Rates modules are not available for Sugar Serve users. For more information on license types and the functionality available for each, refer to the [User Management](#) documentation.

Working With Products- and Quotes-Related Modules

The Product Catalog and Product Categories modules use Sugar's Sidecar user

interface. The following links will open specific sections of the User Interface documentation where you can read about views and actions that are common across most Sidecar modules. The sections following this table describe behaviors and functionality specific to the Products- and Quotes-related modules.

Content Link	Description
Creating Records Basic Record Creation Creating Via Subpanels Creating Via Duplication Importing Records	<p>The Creating Records section covers the various methods of creating new records, including via the Create button in the module, via the subpanel on related module records, duplication of an existing record, and importing a list of records into Sugar using a .csv spreadsheet.</p>
Viewing Records Viewing Via List View Viewing Via Record View Viewing Via Recently Viewed Viewing Via Preview Viewing Via Reports	<p>The Viewing Records section describes the various methods of viewing records, including via the list view and record view, the Recently Viewed menu in the module tab, previewing records in the right-hand side panel, and reports displaying the record's data.</p>
Searching for Records Global Search List View Search Creating a Filter Saving a Filter	<p>The Searching for Records section provides an introduction to the two searching methods for locating Sugar records: global search, which searches across all Sugar modules, and list view search, which searches and filters within the module.</p>
List View Total Record Count Create Button List View Search Checkbox Selection Mass Actions Menu Favorite Designation Column Reordering Column Resizing Column Sorting Column Selection Preview Record Actions Menu More Records Dashboards	<p>The List View section walks through the many elements of the List View layout, which contains a filterable list of all records in the current module. While the generic menu options are described in the User Interface sections linked to the left, the options specifically available in the list view are described in the List View Mass Actions Menu and List View Record Actions Menu sections of the module overviews below.</p> <p>Note: You can only mark records as favorites via the Product Catalog list view.</p>
Record View	<p>The Record View section walks through</p>

[Favorite Designation](#)
[Next or Previous Record](#)
[Actions Menu](#)
[Show More](#)
[Dashboards](#)

the many elements of the Record View layout, which contains detailed information about a single record. While the generic menu options are described in the User Interface sections linked to the left, the options specifically available in the record view are described in the Record View Actions Menu sections of the module overview sections below.

Note: You can only mark records as favorites via the Product Catalog record view.

[Editing Records](#)
[Editing Inline Via Record View](#)
[Editing Via Record View](#)
[Editing Inline Via Subpanels](#)
[Editing Inline Via List View](#)
[Mass Editing Via List View](#)

The Editing Records section describes the various methods of editing existing records, including inline via the record view, in full edit mode on the record view, inline via the subpanel on related module records, inline via the list view, and via the Mass Update option on the list view.

[Deleting Records](#)
[Deleting Via Record View](#)
[Deleting Via List View](#)
[Mass Deleting Via List View](#)

The Deleting Records section describes the various methods of deleting unwanted records, including via the record view, an individual record's Actions menu on the list view, and the Mass Actions menu on the list view.

[Exporting Records](#)

The Exporting Records section provides an introduction to the export functionality, which allows you to download a list of records and all their data as a .csv file for use outside of Sugar (e.g. in Microsoft Excel).

[Recalculating Calculated Values](#)

The Recalculating Calculated Values section provides instructions on utilizing the Recalculate Values list view option to update calculated field values in the module if the administrator has changed the field's formula via Admin > Studio.

[Finding Duplicate Records](#)

The Finding Duplicate Records section provides instructions for locating duplicate records. If searching on matching fields (e.g. Name) identifies

	one or more duplicates, they can be merged into a single record.
Merging Records Merging Via List View	The Merging Records section provides instructions for merging duplicates, which combines field values and related records into a single record.
Favoriting Records Favoriting via List View Favoriting via Record View	<p>The Favoriting Records section describes the various methods of marking records as favorites, including via the list view and record view.</p> <p>Note: You can only mark records as favorites via the Product Catalog module. Favoriting a product catalog record allows you to easily access the product from the list view, Product Catalog Quick Picks dashlet, or the Product Catalog module tab. For more information on the Product Catalog Quick Picks dashlet, please refer to the Opportunities or Quotes documentation.</p>
Sharing Records	The Sharing Records section provides instructions for the Share record view option, which composes an email with a link to the record. If the recipient is logged into Sugar, clicking the link will bring them directly to the record view.

Product Catalog

Sugar's Product Catalog module contains a list of all products or services that your organization sells. This module provides the [Quoted Line Items](#) and [Revenue Line Items](#) modules with the template used when creating products to be used for [Opportunities](#) and [Quotes](#), including pricing and cost information and information about the [manufacturer](#).

Note: The Quoted Line Items and Revenue Line Items modules are not available for Sugar Serve users. For more information on license types and the functionality available for each, refer to the [User Management](#) documentation.

Products within the Product Catalog can be broadly classified into [product types](#), such as Software and Hardware. Each product type can be further organized into several [product categories](#). For example, the software product type can contain product categories such as Spreadsheets and Word Processors. You can also create sub-categories within a category.

This documentation will cover information and actions specific to the Product Catalog. For instructions concerning views and actions which are common across most Sugar modules, such as creating, editing, and deleting records, please refer to the [Working With Products- and Quotes-Related Modules](#) section of this page.

Product Catalog Fields

The Product Catalog contains a number of stock fields that come out-of-the-box with Sugar. For information on using and editing various field types, refer to the [User Interface](#) documentation. The definitions below are suggested meanings for the fields, but the fields can be leveraged differently to best meet your organization's needs. Fields can be altered, added, or removed via Admin > Studio. For more information on configuring fields, please refer to the [Studio](#) documentation in the Administration Guide.

Field	Description
Availability	Select if the item is in stock or not from the dropdown list
Category Type	The product category to which the new item belongs
Cost	The actual cost of the item. This will not appear on printed quotes
Currency	The currency of the given prices (Cost, List, Unit)
Date Available	Select the date of availability if the item is out of stock
Date Created	The date the product catalog record was created
Date Modified	The date the product catalog record was last modified
Date-Cost-Price	The starting date that the cost is valid
Default Pricing Formula	Select a formula from the dropdown list to arrive at the discount price for the Unit Price field. The formulas are as follows:

	<ul style="list-style-type: none"> • Fixed Price: Allows you to enter a Unit Price without any calculation. • Profit Margin: Enter the points in the adjoining field to vary the percentage against the cost. • Markup over Cost: Choose a percentage to raise the price over the cost. • Discount from List: Enter the discount percentage from the List Price in the adjoining field. • Same as List: The Unit Price will be the same as the List Price.
Description	A description or other information about the product
List Price	The quotable list price of the product
Manufacturer Name	The manufacturer of the product
Mft. Part Number	The manufacturer's part number for the product
Product Name	The name of the product
Product URL	The web address of product if it is available online
Quantity in Stock	Enter the number of units that are in stock of the product Note: Negative values are supported in this field.
Renewable ¹	Activated when the Service field is set to yes, select whether or not the service offered can be renewed for additional time periods. When "Renewable" equals yes, it will trigger the renewal pipeline automation feature for Sugar Sell users.
Service ¹	Designate this product catalog record as a service. Enabling the Service field will make the Service Duration (required) and Renewable fields available.
Service Duration ¹	Required when the Service field is set to yes, set the period of time that this service covers. When the Renewable

	field is also set to yes, the Service Duration will determine the expected close date for future service opportunities.
Support Contact	The support person's contact information, such as the phone number or email address
Support Desc.	Brief description or other information regarding the support provided
Support Name	The name of the Customer Support person
Support Term	The term (e.g. six months, one year, etc.) in which support will be provided for the product
Tags	User-created keywords that can be used to identify records in filters, dashlets, and reports Note: For more information on creating and using tags, please refer to the Tags documentation.
Tax Class	Tax classification (e.g. taxable, non-taxable) for the product
Type	The specified product type
Unit Price	The unit price of the product
Vendor Part Number	The vendor's part number for the product
Weight	The weight of the product Note: Negative values are supported in this field.

1. For more information on service-related fields in Sugar Sell, refer to the Services and Renewable Revenue Line Items section of the [Opportunities](#) documentation in the Application Guide.

Product Catalog Menus

The Product Catalog module contains various options that are available via menus in the module tab, list view, and record view. The following sections present each menu and its options with links to more information about each option in the User

Interface documentation or, for module-specific functionality, within this page.

Module Tab Menu

The Product Catalog module tab can be accessed by clicking the Product Catalog option in the Admin menu. Click the tab to access the Product Catalog [list view](#). You may also click the triangle in the Product Catalog tab to display the Actions, Recently Viewed, and Favorites menus. The Actions menu allows you to perform important actions within the module. The [Recently Viewed menu](#) displays the list of product catalog records you last viewed in the module. The [Favorites menu](#) displays the list of products you most recently marked as favorites.

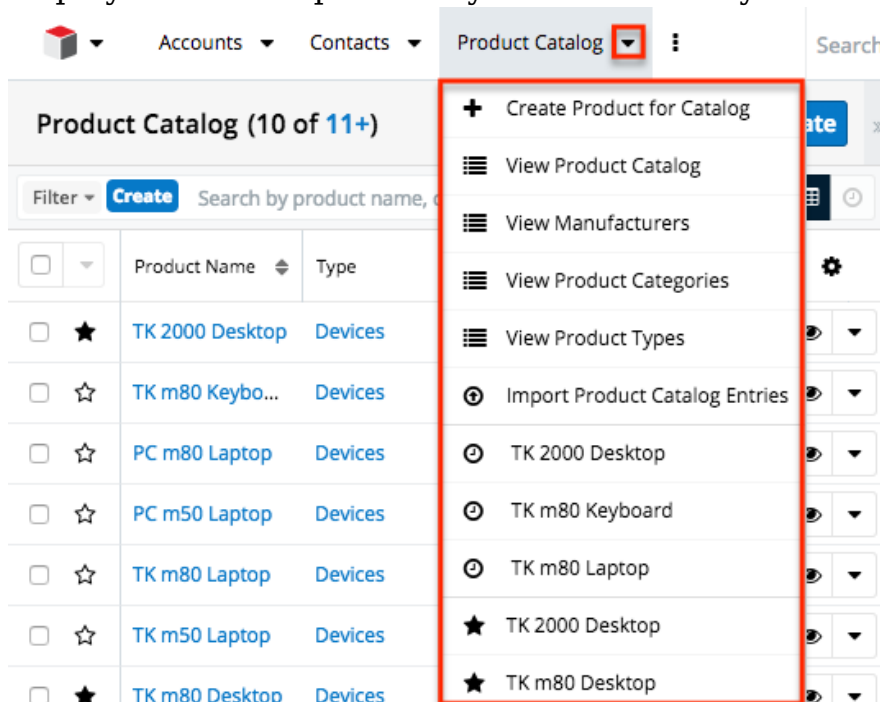

The Product Catalog's Actions menu allows you to perform the following operations:

Menu Item	Description
Create Product for Catalog	Opens the record view layout to create a new product for the catalog
View Product Catalog	Opens the list view layout to search and display the product catalog
View Manufacturers	Opens the Manufacturers list view
View Product Categories	Opens the Product Categories list view
View Product Types	Opens the Product Types list view
Import Product Catalog Entries	Opens the import wizard to create or

	update product catalog entries using external data
--	--

List View Menus

The Product Catalog list view displays all product catalog records meeting the current search criteria. You can view the basic details of each product within the field columns. Please note that you will only be able to see product catalog records as allowed by your user access type (Developer) and assigned roles. For more information on roles, please refer to the [Role Management](#) documentation.

Users with administrator or developer access have the ability to change what fields are visible in the list view via Admin > Studio. For more information on editing layouts, please refer to the [Studio](#) documentation.

Mass Actions Menu

The Mass Actions menu to the right of the checkbox option allows you to perform various actions on the currently selected records.

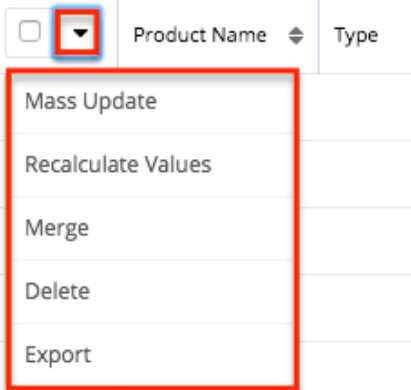



The options in the Mass Actions menu allow you to perform the following operations:

Menu Item	Description
Mass Update	Mass update one or more product catalog records at a time
Recalculate Values	(Available in certain circumstances) Updates calculated values to reflect changes to calculated fields made in Studio

Merge	Merge two or more duplicate products
Delete	Delete one or more product catalog records at a time
Export	Export one or more product catalog records to a CSV file

Record Actions Menu

The Record Actions menu to the right of each record's Preview button allows users to edit, follow, or delete specific records directly from the list view.

Product Name	Category Name	Availability	Quantity in Sto...	
Verlie Gadget	Albaugh Widgets	In Stock	12	 
Kira Gadget	Albaugh Widgets	In Stock	13	Edit
Hipolito Gadget	Albaugh Widgets	In Stock	58	Delete

The options in the Record Actions menu allow you to perform the following operations:

Menu Item	Description
Preview (Eye icon)	Preview this product in the intelligence pane
Edit	Edit this product
Delete	Delete this product

Record View Actions Menu

The Product Catalog record view displays thorough product information including all product fields. The record view can be reached by clicking a product record's link in the Product Catalog list view. You have the ability to change the record view by configuring the layout via Admin > Studio. For more information on editing layouts, please refer to the [Studio](#) documentation.

The Actions menu on the top right of each product's record view allows you to perform various actions on the current record.

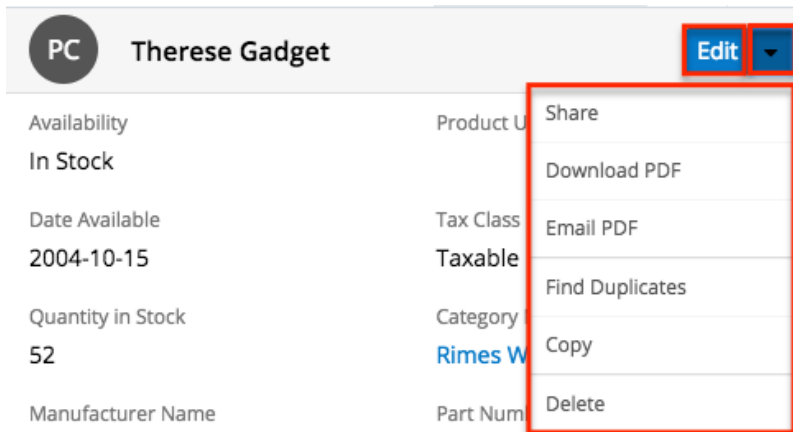

The options in the Actions menu allow you to perform the following operations:

Menu Item	Description
Edit	Edit this product
Share	Share a link to this product via email
Download PDF	Download product information as a PDF file
Email PDF	Email product information as a PDF attachment
Find Duplicates	Locate potential duplicates of this product
Copy	Duplicate this product
Delete	Delete this product

Product Categories

The Product Categories module allows you to create categories to group records under a Product Type. This is one of the levels of organization you can use for the products and services that your organization offers, and will contain multiple entries from the [product catalog](#).

This documentation will cover information and actions specific to the Product Catalog. For instructions concerning views and actions which are common across most Sugar modules, such as creating, editing, and deleting records, please refer to the [Working With Products- and Quotes-Related Modules](#) section of this page.

Product Category Fields

The Product Category module contains four stock fields that come out-of-the-box with Sugar. For information on using and editing various field types, refer to the [User Interface](#) documentation. The definitions below are suggested meanings for the fields.

Field	Description
Product Category	The category's name as it will appear on the Product Category dropdown list
Parent Category	Select a parent product category if this product category is a sub-set of another category
Description	A description or other information about the product category
Order	Enter a number to specify the order in which this category will appear in the Product Category dropdown list

Product Category Menus

The Product Categories module contains various options and functions that are available via menus in the module tab, list view, and record view. The following sections present each menu and its options with links to more information about each option in the User Interface documentation or, for module-specific functionality, within this page.

Module Tab Menu

The Product Categories module tab can be accessed by clicking the Product Categories option on the Admin page. Click the tab to access the Product Categories list view. You may also click the triangle in the Product Categories tab to display the Actions and Recently Viewed menus. The Actions menu allows you to perform important actions within the module. The [Recently Viewed menu](#) displays the list of product category records you last viewed in the module.

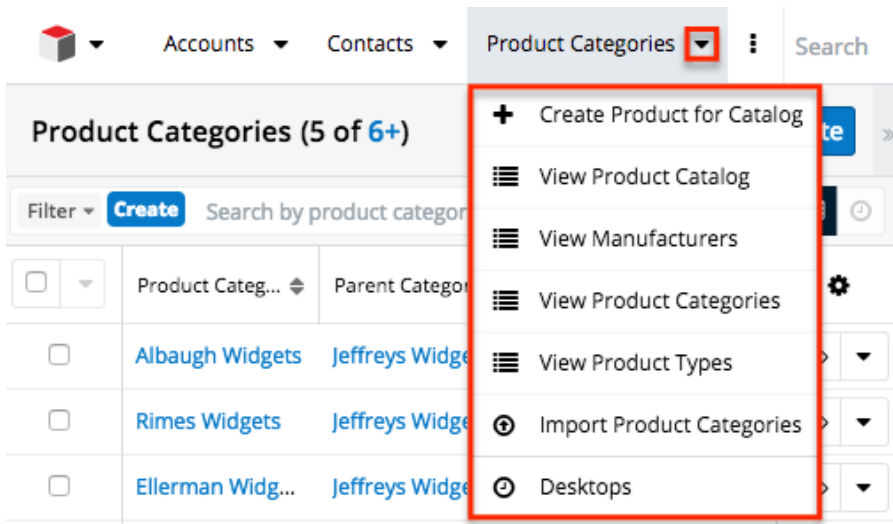

The Actions menu allows you to perform the following operations:

Menu Item	Description
Create Product for Catalog	Opens the product catalog's record view to create a new product for the catalog
View Product Catalog	Opens the Product Catalog list view
View Manufacturers	Opens the Manufacturers list view
View Product Categories	Opens the Product Categories list view
View Product Types	Opens the Product Types list view
Import Product Categories	Opens the import wizard to create or update product categories using external data

List View Menus

The Product Categories list view displays all product category records. You can view the basic details of each product category within the field columns. You can also click on a category's name to [edit](#) it or [delete](#) the category by clicking the "Delete" button at the end of the row.

Mass Actions Menu

The Mass Actions menu to the right of the checkbox option allows you to perform various actions on the currently selected records.

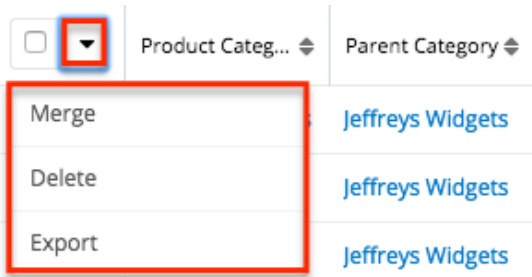

The options in the Mass Actions menu allow you to perform the following operations:

Menu Item	Description
Merge	Merge two or more duplicate product categories
Delete	Delete one or more product categories at a time
Export	Export one or more product categories to a CSV file

Record Actions Menu

The Record Actions menu to the right of each record's Preview button allows users to edit or delete specific records directly from the list view.

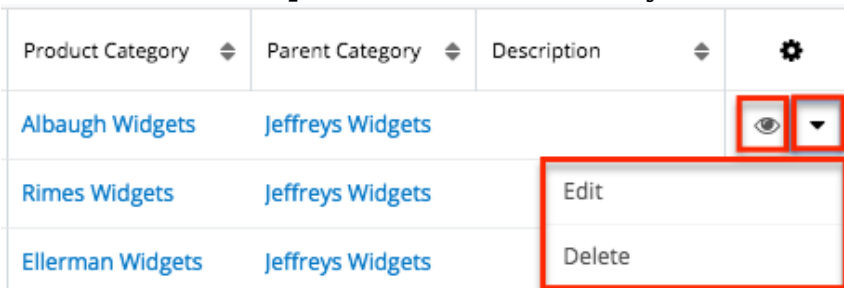

The options in the Record Actions menu allow you to perform the following operations:

Menu Item	Description
Preview (Eye icon)	Preview this category in the intelligence pane
Edit	Edit this product category
Delete	Delete this product category

Record View Actions Menu

The Product Categories record view displays product category information including all relevant fields. The record view can be reached by clicking a product category's link from the Product Categories list view.

The Actions menu on the top right of each product category's record view allows you to perform various actions on the current record.

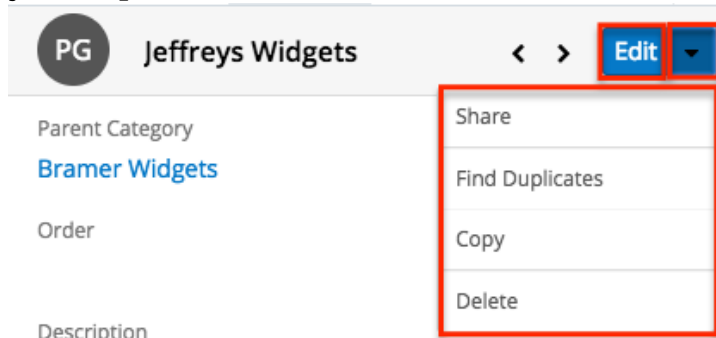

The options in the Actions menu allow you to perform the following operations:

Menu Item	Description
Edit	Edit this product category
Share	Share a link to this product category
Find Duplicates	Locate potential duplicates of this product category
Copy	Duplicate this product category
Delete	Delete this product category

Product Types

The Product Types module controls the Type dropdown list in the [Product Catalog fields](#). In addition to [product categories](#), the product type allows you to define the classification of a product or service that is being offered on a product catalog record.

This documentation will cover information and actions specific to the product types. For instructions concerning views and actions which are common across most Sugar modules, such as creating, editing, and deleting records, please refer

to the [Working With Products- and Quotes-Related Modules](#) section of this page.

Product Type Fields

The Product Types module contains three stock fields that come out-of-the-box with Sugar. For information on using and editing various field types, refer to the [User Interface](#) documentation. The definitions below are suggested meanings for the fields.

Field	Description
Product Type	The product type's name as it will appear on the Type dropdown list in the product catalog
Description	A description or other information about the product type
Order	Enter a number to specify the order in which this product type will appear in the Type dropdown list

Product Type Menus

The Product Types module contains various options and functions that are available via menus in the module tab, list view, and record view. The following sections present each menu and its options with links to more information about each option in the User Interface documentation or, for module-specific functionality, within this page.

Module Tab Menu

The Product Types module tab can be accessed by clicking the Product Types option in the Admin menu. Click the tab to access the Product Types list view. You may also click the triangle in the Product Types tab to display the Actions and Recently Viewed menus. The Actions menu allows you to perform important actions within the module. The [Recently Viewed menu](#) displays the list of product type records you last viewed in the module.

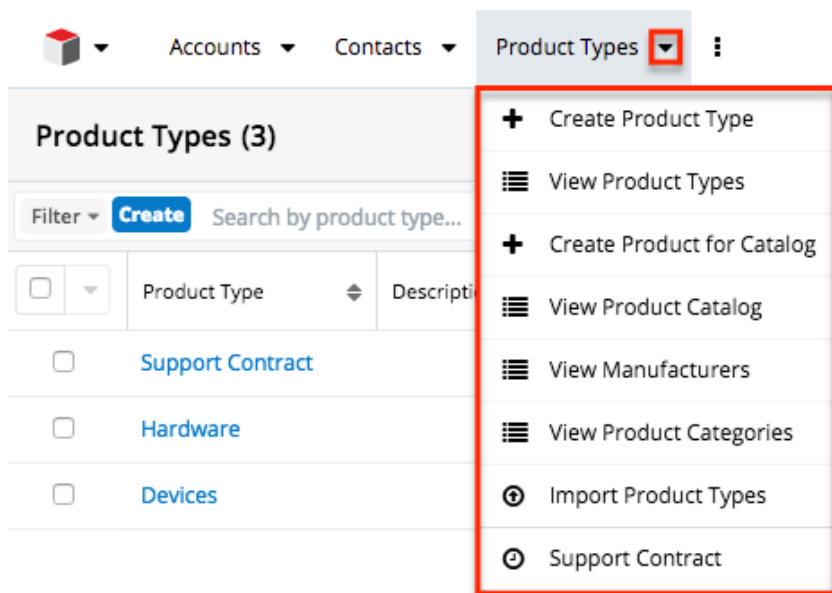

The Actions menu allows you to perform the following operations:

Menu Item	Description
Create Product Type	Opens the Product Types list view to create a product
View Product Types	Opens the Product Types list view
Create Product for Catalog	Opens the Product Catalog record view to create a new product for the catalog
View Product Catalog	Opens the Product Catalog list view
View Manufacturers	Opens the Manufacturers list view
View Product Categories	Opens the Product Categories list view
Import Product Types	Opens the import wizard to create or update product types using external data

List View Menus

The Product Types list view displays all product type records. You can view the basic details of each product type within the field columns. You can also click on a product type's name to [edit](#) or [delete](#) the category by clicking the "Delete" button at the end of the record's row in the list view.

Mass Actions Menu

The Mass Actions menu to the right of the checkbox option allows you to perform various actions on the currently selected records.

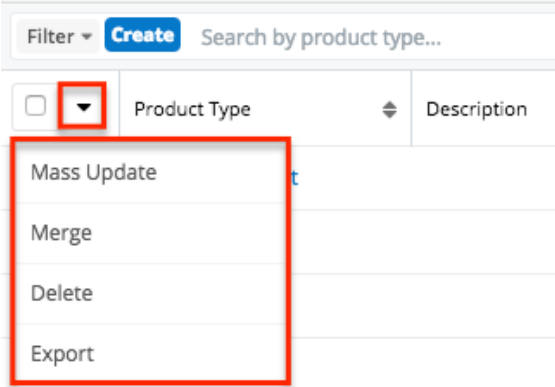

The options in the Mass Actions menu allow you to perform the following operations:

Menu Item	Description
Mass Update	Mass update one or more product type records at a time
Merge	Merge two or more duplicate product types
Delete	Delete one or more product types at a time
Export	Export one or more product types to a CSV file

Record Actions Menu

The Record Actions menu to the right of each record's Preview button allows users to edit or delete specific records directly from the list view.

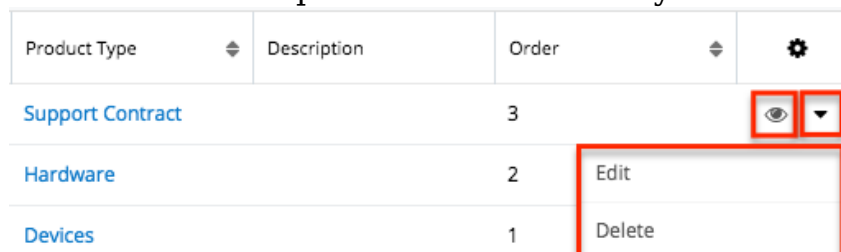

The options in the Record Actions menu allow you to perform the following operations:

Menu Item	Description
Preview (Eye icon)	Preview this product type in the intelligence pane
Edit	Edit this product type
Delete	Delete this product type

Record View Actions Menu

The Product Types record view displays product type information including all relevant fields. The record view can be reached by clicking a product type's link from the Product Types list view.

The Actions menu on the top right of each product type's record view allows you to perform various actions on the current record.

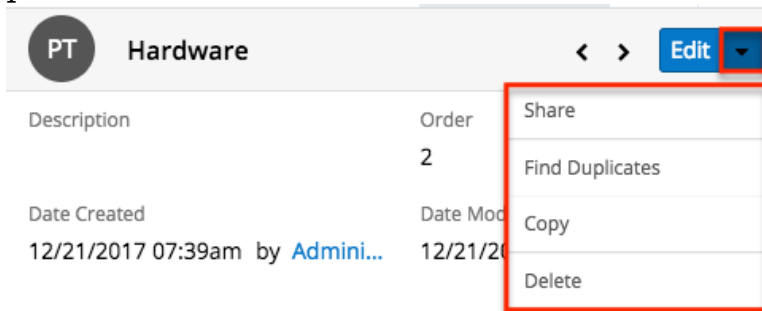

The options in the Actions menu allow you to perform the following operations:

Menu Item	Description
Edit	Edit this product type
Share	Share a link to this product type
Find Duplicates	Locate potential duplicates of this product type
Copy	Duplicate this product type
Delete	Delete this product type

Ordering Product Types

The Order field in Product Types defines the order of the different type options when viewing the Type dropdown list of a [Product Catalog](#) record. The Order field

allows you to organize what order the dropdown list will display, with 1 being the highest on the list and moving down as the order number rises. When [creating](#) new product type record options, the Order field will automatically increment to the next number in the list, thereby adding the new option to the bottom of the list. The Order field can be overwritten with another number if you would like to manually re-order the options.

Quotes Configuration

The Quotes Configuration page allows you to specify the fields and their order which are available when working with quote records. When viewing or editing a quote in record view, the quote worksheet appears beneath its panels of fields. This is where product groups, quoted line items, and comments can be created and rearranged along with any discounts, taxes, or shipping fees. The worksheet is broken into three portions, the Summary Bar Header, Worksheet Columns, and Grand Totals Footer.

Note: The Quotes Configuration functionality is not available for Sugar Serve users. For more information on license types and the functionality available for each, refer to the [User Management](#) documentation.

To modify each section's available fields and field order, click the desired section in the Quotes Configuration page. Doing so will open that section's preview on the left and the list of available, displayed, and related fields to the right. Click the boxes next to each field to toggle whether it is displayed or not.

The screenshot shows the 'Quotes Configuration' interface. On the left, the 'Worksheet Columns' section is active, displaying a preview table with columns: 'List Price', 'Quanti...', 'Line Item', and 'Part Num'. The 'List Price' column is highlighted with a red box. On the right, the 'Fields Legend' panel is visible, showing a legend for 'Available', 'Displayed', and 'Related' fields. Below the legend, a list of fields is shown: 'Account Name', 'List Price', 'Asset Number', and 'List Price (US Dollar)'. The 'List Price' field is checked and highlighted with a red box.

The meanings of the three display statuses are as follows:

- **Available (Empty Box)** : The field is not displayed in the worksheet nor is it being used in the calculation of a displayed field.
- **Related (Solid Box)** : The field is not displayed in the worksheet. It is being used in the calculation of a displayed field. Hovering over a field

marked as "Related" shows a list of fields that use it in their calculations.

- **Displayed (Checked Box)** : The field is displayed in the worksheet. It may also be being used in the calculation of another displayed field.

All fields belonging to the Quotes module will be available for use in the Summary Bar Header section while the Grand Totals Footer section allows selection of any currency fields in the Quotes module. Fields belonging to the Quoted Line Items module are available for the Worksheet Columns section. Beneath each section's preview, the list of default fields for that section is displayed. Clicking the Restore Defaults link will revert any changes so that the section displays the default list of fields. For more information about the worksheet and its sections, refer to the [Quotes](#) documentation in the Application Guide.

Note: Image fields marked to display will be read-only in the quotes worksheet.

To rearrange the fields within a section, simply drag and drop each field in the section's preview.

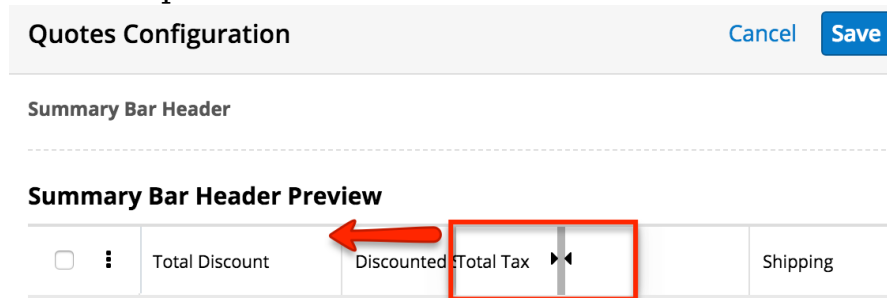

Once you have configured each section as desired, click "Save" to finalize your changes. Clicking "Cancel" will revert your changes.

Note: Changes made to the quotes worksheet will not apply when working with quotes within Sugar Mobile.

Manufacturers

The Manufacturers module controls and maintains the Manufacturer Name field in the [Product Catalog](#) module. The Manufacturer Name field allows you to select from a list of the manufacturers you use to classify your products and specify from which manufacturer they are produced.

Manufacturer Fields

The Manufacturers module contains three stock fields that come out-of-the-box with Sugar. For information on using and editing various field types, refer to the [User Interface](#) documentation. The below definitions are suggested meanings for

the fields.

Field	Description
Manufacturer	The manufacturer's name as it will appear in the Manufacturer Name field in the product catalog
Status	Select "Active" or "Inactive" to indicate which manufacturers are displayed as options in the Manufacturer Name field
Order	Enter a number to specify the order in which this category will appear in the Manufacturer Name field list

Manufacturer Menus

The Manufacturers module contains various options and functions that are available via menus in the module tab, list view, and record view. The following sections present each menu and its options with links to more information about each option in the User Interface documentation or, for module-specific functionality, within this page.

Module Tab Menus

The Manufacturers list view can be accessed by navigating to the Admin page and selecting "Manufacturers" under the Product and Quotes panel. Click the tab to access the Manufacturers list view. You may also click the triangle in the Manufacturers tab to display the Actions and Recently Viewed menus. The Actions menu allows you to perform important actions within the module. The [Recently Viewed menu](#) displays the list of manufacturers you most recently viewed.

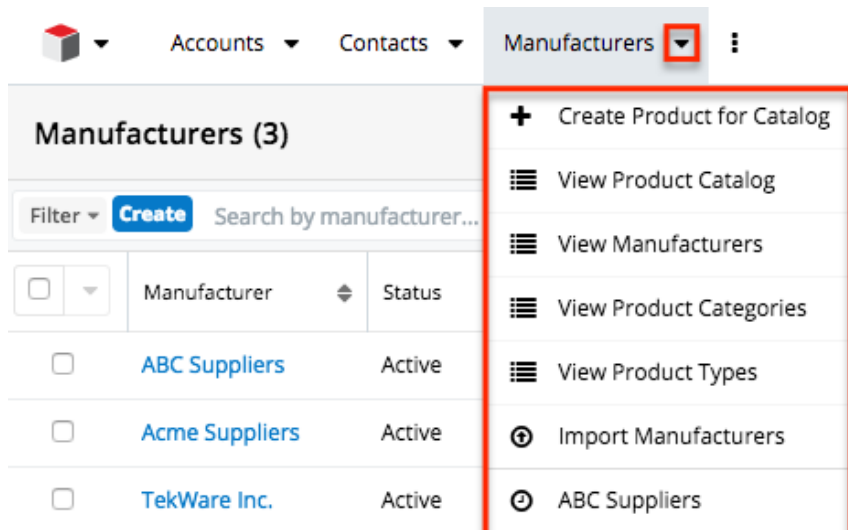

The module tab's Actions menu allows you to perform the following operations:

Menu Item	Description
Create Product for Catalog	Opens the Product Catalogs record view to create a new product for the catalog
View Product Catalog	Opens the Product Catalog list view layout to search and display product catalogs
View Manufacturers	Opens the Manufacturers list view to search and display manufacturers
View Product Categories	Opens the Product Categories list view to search and display product categories
View Product Types	Opens the Product Types list view to search and display product categories
Import Manufacturers	Opens the import wizard to create or update manufacturers using external data

List View Menus

The Manufacturers [list view](#) displays all manufacturer records and allows for searching and filtering to locate specific manufacturers. You can view the basic details of each record within the field columns of the list view or click the manufacturer's name to open the record view. To access the module's list view, simply navigate to the Admin page and select "Manufacturers" under the Product and Quotes panel. You can also click the module's tab in the navigation bar once

the Manufacturers module opens.

List View Mass Actions Menu

The Mass Actions menu to the right of the checkbox option in the list header allows you to perform mass actions on all currently selected records. You can use the checkbox on each record's row to select individual manufacturer records or click the checkbox in the list header to select all records displayed on the current set of list view results.

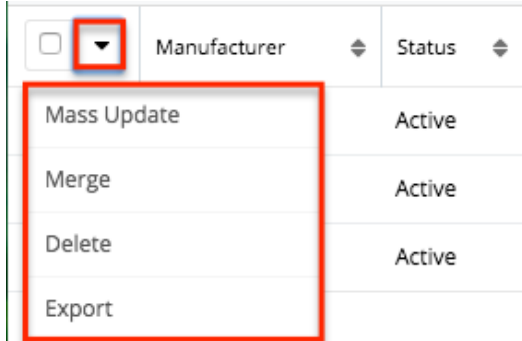



The Mass Actions menu allows you to perform the following operations:

Menu Item	Description
Mass Update	Mass update one or more manufacturer records at a time
Merge	Merge two or more duplicate manufacturers
Delete	Delete one or more manufacturer records at a time
Export	Export one or more manufacturer records to a CSV file

List View Record Actions Menu

The Record Actions menu to the far right of each record's row allows you to perform actions on individual manufacturer records directly from the list view.

Manufacturer	Status	Order	
ABC Suppliers	Active	1	 
Acme Suppliers	Active		<ul style="list-style-type: none"> Edit Delete
TekWare Inc.	Active		

The list view's Record Actions menu allows you to perform the following operations:

Menu Item	Description
Preview (Eye icon)	Preview this manufacturer in the intelligence pane
Edit	Edit this manufacturer
Delete	Delete this manufacturer

Record View Actions Menu

The Manufacturer's [record view](#) displays a single manufacturer in full detail including its fields. To access a manufacturer's record view, simply click the hyperlinked manufacturer name in the Manufacturers list view. The record view's Actions menu appears on the top right of the page and allows you to perform various operations on the current record.

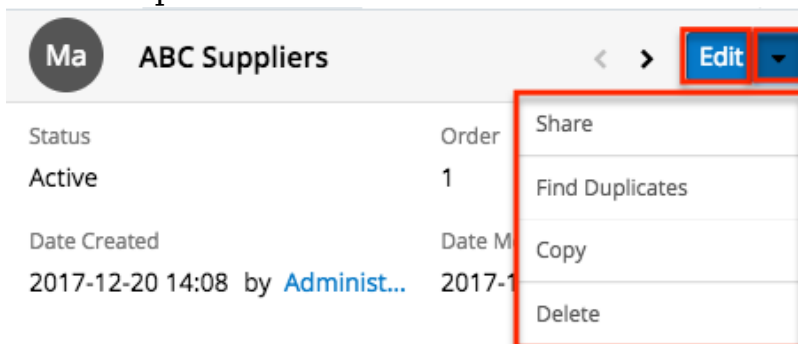

The screenshot shows the record view for 'ABC Suppliers'. At the top right, there is a blue 'Edit' button with a dropdown arrow. Below it, an actions menu is open, listing the following options: 'Share', 'Find Duplicates', 'Copy', and 'Delete'. The menu items are highlighted with a red box.

The Actions menu allows you to perform the following operations:

Menu Item	Description
Edit	Edit this manufacturer
Share	Share a link to this manufacturer via email

Find Duplicates	Locate potential duplicates of this manufacturer
Copy	Duplicate this manufacturer
Delete	Delete this manufacturer

Ordering Manufacturers

The Order field in the module defines the order in which the manufacturer options are displayed in the corresponding Manufacturer Name field of the [Product Catalog](#) module. Enter the numeric value (e.g. 1, 2, 3) in the manufacturer record's Order field to determine the order it will display in the corresponding field list (Manufacturer Name). For example, a manufacturer record with an order value of "1" will display at the top of the list followed by the next value (e.g. 2), and so forth. When creating new manufacturer records, the Order field will automatically increment to the next number in the list, thereby adding the new option to the bottom of the list. The Order field can be overwritten with another number if you would like to manually re-order the options.

Shipping Providers

The Shipping Providers module controls and maintains the Shipping Provider field in the [Quotes](#) module. The Shipping Provider field allows you to determine how you are going to transport the purchased products or services to the customer.

Note: The Shipping Providers module is not available for Sugar Serve users. For more information on license types and the functionality available for each type, refer to the [User Management](#) documentation.

Shipping Provider Fields

The Shipping Provider module contains three stock fields that come out-of-the-box with Sugar. For information on using and editing various field types, refer to the [User Interface](#) documentation. The definitions below are suggested meanings for the fields.

Field	Description
Shipping Provider	The provider's name as it will appear in the Shipping Provider field of the

	Quotes module
Status	Select "Active" or "Inactive" to indicate which shipping providers are displayed as options in the Shipping Provider field
Order	Enter a number to specify the order in which this shipping provider option will appear in the quote's Shipping Provider field list

Shipping Provider Menus

The Shipping Providers module contains various options and functions that are available via menus in the module tab, list view, and record view. The following sections present each menu and its options with links to more information about each option in the User Interface documentation or, for module-specific functionality, within this page.

Module Tab Menus

The Shipping Providers list view can be accessed by navigating to the Admin page and selecting "Shipping Providers" under the Product and Quotes panel. Click the tab to access the Shipping Providers list view. You may also click the triangle in the Shipping Providers tab to display the Actions and Recently Viewed menus. The Actions menu allows you to perform important actions within the module. The [Recently Viewed menu](#) displays the list of shipping providers you most recently viewed.

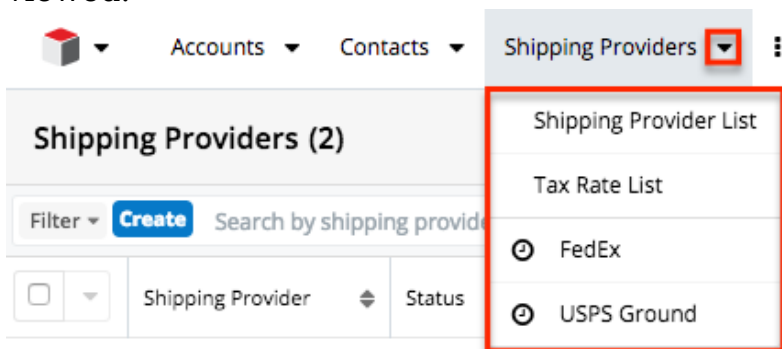

The module tab's Actions menu allows you to perform the following operations:

Menu Item	Description
Shipping Provider List	Opens the Shipping Providers list view

	layout to search and display shipping providers
Tax Rate List	Opens the Tax Rates list view layout to search and display tax rates

List View Menus

The Shipping Providers [list view](#) displays all shipping provider records and allows for searching and filtering to locate specific shipping providers. You can view the basic details of each record within the field columns of the list view or click the shipping provider's name to open the record view. To access the module's list view, simply navigate to the Admin page and select "Shipping Providers" under the Product and Quotes panel. You can also click the module's tab in the navigation bar once the Shipping Providers module opens.

List View Mass Actions Menu

The Mass Actions menu to the right of the checkbox option in the list header allows you to perform mass actions on all currently selected records. You can use the checkbox on each record's row to select individual shipping provider records or click the checkbox in the list header to select all records displayed on the current set of list view results.

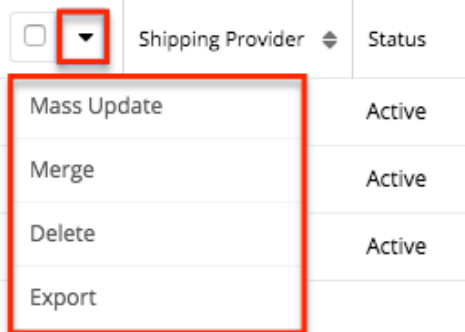



The Mass Actions menu allows you to perform the following operations:

Menu Item	Description
Mass Update	Mass update one or more shipping provider records at a time
Merge	Merge two or more duplicate shipping providers
Delete	Delete one or more shipping provider records at a time

Export	Export one or more shipping provider records to a CSV file
------------------------	--

List View Record Actions Menu

The Record Actions menu to the far right of each record's row allows you to perform actions on individual shipping provider records directly from the list view.

Shipping Provider	Status	Order	
DHL	Active	3	 
USPS Ground	Active	<div style="border: 2px solid red; padding: 2px;"> Edit </div>	
FedEx	Active	<div style="border: 2px solid red; padding: 2px;"> Delete </div>	

The list view's Record Actions menu allows you to perform the following operations:

Menu Item	Description
Preview (Eye icon)	Preview this shipping provider in the intelligence pane
Edit	Edit this shipping provider
Delete	Delete this shipping provider

Record View Actions Menu

The Shipping Providers [record view](#) displays a single shipping provider in full detail including its fields. To access a shipping provider's record view, simply click the hyperlinked shipping provider name in the Shipping Providers list view. The record view's Actions menu appears on the top right of the page and allows you to perform various operations on the current record.

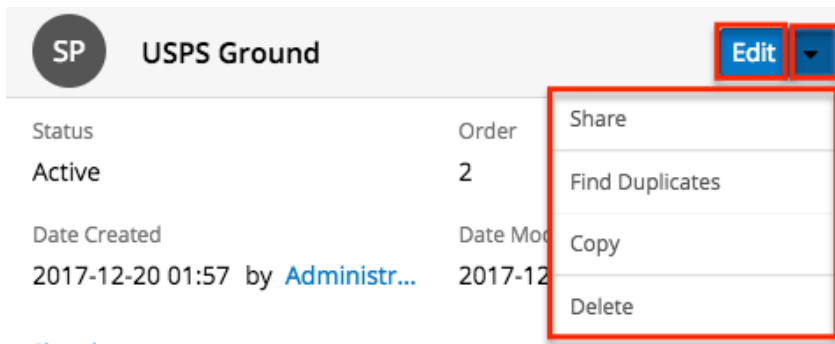

The Actions menu allows you to perform the following operations:

Menu Item	Description
Edit	Edit this shipping provider
Share	Share a link to this shipping provider via email
Find Duplicates	Locate potential duplicates of this shipping provider
Copy	Duplicate this shipping provider
Delete	Delete this shipping provider

Ordering Shipping Providers

The Order field in the module defines the order in which the shipping provider options are displayed in the corresponding Shipping Provider field of the [Quotes](#) module. Enter the numeric value (e.g. 1, 2, 3) in the shipping provider record's Order field to determine the order it will display in the corresponding field list (Shipping Provider) on the quote record. For example, a shipping provider record with an order value of "1" will display at the top of the list followed by the next value (e.g. 2), and so forth. When creating new shipping provider records, the Order field will automatically increment to the next number in the list, thereby adding the new option to the bottom of the list. The Order field can be overwritten with another number if you would like to manually re-order the options.

Tax Rates

The Tax Rates module controls and maintains the Tax Rates field in the [Quotes](#) module. The Tax Rates field allows you to apply the applicable tax rate to the quote's taxable subtotal. Tax rates can be added as any necessary percentage, so they will be able to include national and international rates.

Note: The Tax Rates module is not available for Sugar Serve users. For more information on license types and the functionality available for each type, refer to the [User Management](#) documentation.

Tax Rate Fields

The Tax Rate module contains four stock fields that come out-of-the-box with Sugar. For information on using and editing various field types, refer to the [User Interface](#) documentation. The below definitions are suggested meanings for the fields.

Field	Description
Tax Rate Name	The tax rate's name as it will appear in the Tax Rate field of the Quotes module
Percentage	The percentage of the quote's subtotal that will be taxed
Status	Select "Active" or "Inactive" to indicate which tax rates are displayed as options in the Tax Rate field
Order	Enter a number to specify the order in which this tax rate option will appear in the quote's Tax Rate field list

Tax Rate Menus

The Tax Rates module contains various options and functions that are available via menus in the module tab, list view, and record view. The following sections present each menu and its options with links to more information about each option in the User Interface documentation or, for module-specific functionality, within this page.

Module Tab Menus

The Tax Rates list view can be accessed by navigating to the Admin page and selecting "Tax Rates" under the Product and Quotes panel. Click the tab to access the Tax Rates list view. You may also click the triangle in the Tax Rates tab to display the Actions and Recently Viewed menus. The Actions menu allows you to perform important actions within the module. The [Recently Viewed menu](#) displays the list of tax rates you most recently viewed.

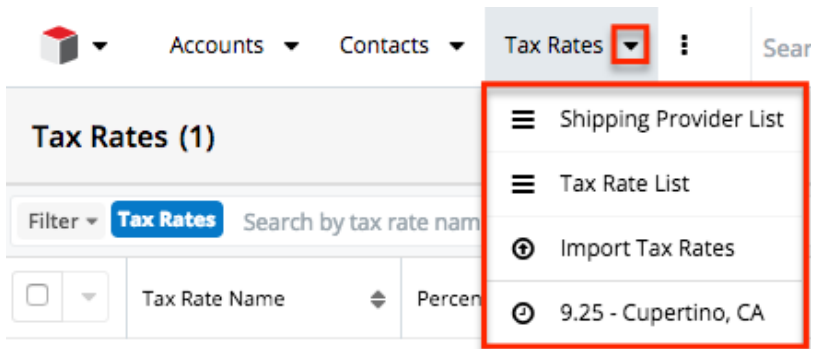

The module tab's Actions menu allows you to perform the following operations:

Menu Item	Description
Shipping Provider List	Opens the Shipping Providers list view layout to search and display shipping providers
Tax Rate List	Opens the Task Rates list view layout to search and display tax rates
Import Tax Rates	Opens the import wizard to create or update tax rates using external data

List View Menus

The Tax Rates [list view](#) displays all tax rate records and allows for searching and filtering to locate specific tax rates. You can view the basic details of each record within the field columns of the list view or click the tax rate's name to open the record view. To access the module's list view, simply navigate to the Admin page and select "Tax Rates" under the Product and Quotes panel. You can also click the module's tab in the navigation bar once the Tax Rates module opens.

List View Mass Actions Menu

The Mass Actions menu to the right of the checkbox option in the list header allows you to perform mass actions on all currently selected records. You can use the checkbox on each record's row to select individual tax rate records or click the checkbox in the list header to select all records displayed on the current set of list view results.

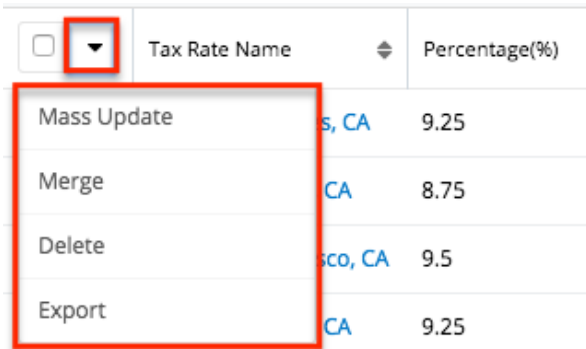

The Mass Actions menu allows you to perform the following operations:

Menu Item	Description
Mass Update	Mass update one or more tax rate records at a time
Merge	Merge two or more duplicate tax rates
Delete	Delete one or more tax rate records at a time
Export	Export one or more tax rate records to a CSV file

List View Record Actions Menu

The Record Actions menu to the far right of each record's row allows you to perform actions on individual tax rate records directly from the list view.

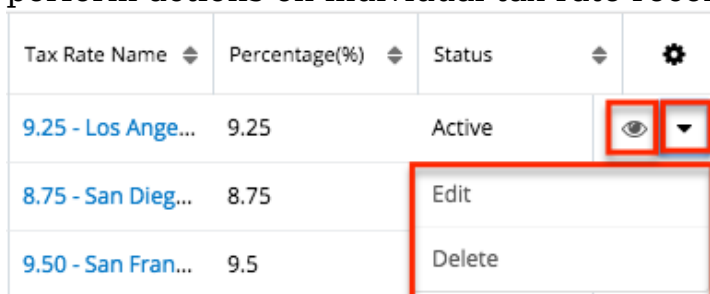

The list view's Record Actions menu allows you to perform the following operations:

Menu Item	Description
Preview (Eye icon)	Preview this tax rate in the intelligence pane

Edit	Edit this tax rate
Delete	Delete this tax rate

Record View Actions Menu

The Tax Rates [record view](#) displays a single tax rate in full detail including its fields. To access a tax rate's record view, simply click the hyperlinked tax rate name in the Tax Rates list view. The record view's Actions menu appears on the top right of the page and allows you to perform various operations on the current record.

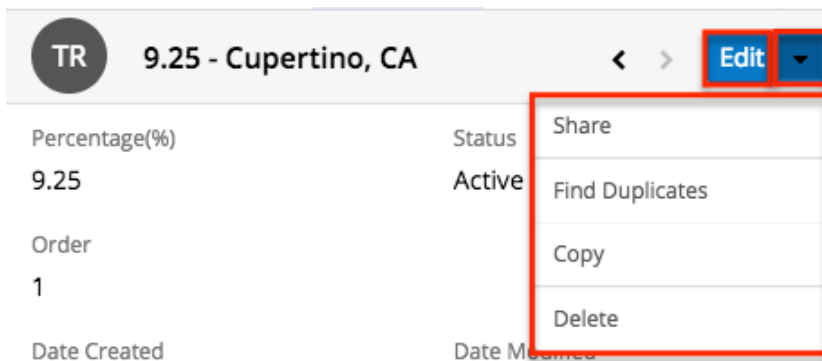

The Actions menu allows you to perform the following operations:

Menu Item	Description
Edit	Edit this tax rate
Share	Share a link to this tax rate via email
Find Duplicates	Locate potential duplicates of this tax rate
Copy	Duplicate this tax rate
Delete	Delete this tax rate

Ordering Tax Rates

The Order field in the module defines the order in which the tax rate options are displayed in the corresponding Tax Rate field of the [Quotes](#) module. Enter the numeric value (e.g. 1, 2, 3) in the tax rate record's Order field to determine the order it will display in the corresponding field list (Tax Rate) of the Quotes module. For example, a tax rate record with an order value of "1" will display at the top of the list followed by the next value (e.g. 2), and so forth. When creating new tax

rate records, the Order field will automatically increment to the next number in the list, thereby adding the new option to the bottom of the list. The Order field can be overwritten with another number if you would like to manually re-order the options.

Last Modified: 2020-01-06 00:14:07

Bug Tracker

Overview

In the [Bugs](#) module, there are two dropdown fields, "Found in Release" and "Fixed in Release", that cannot be edited through normal means. Although these are dropdown fields, they do not show a [dropdown list](#) option in Dropdown Editor to add, remove, and edit the dropdown options.

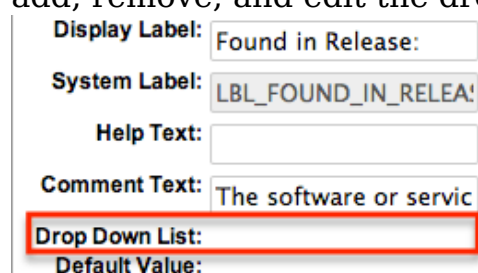

The screenshot shows the configuration interface for a dropdown field. The fields are as follows:

- Display Label: Found in Release:
- System Label: LBL_FOUND_IN_RELEA'
- Help Text: (empty)
- Comment Text: The software or servic
- Drop Down List: (highlighted with a red border)
- Default Value: (empty)

The release dropdown list is instead controlled by the Releases section of the Administration page. The release list is more comprehensive than a standard dropdown list, so each list option needs additional information. This documentation will cover how to use the Releases module to make changes to the list that controls these fields.

Note: The Releases module is not available for Sugar Sell users. For more information on license types and the functionality available for each type, refer to the [User Management](#) documentation.

Release Fields

The Releases module contains three fields which come out-of-the-box with Sugar. These fields are not found in Studio, and therefore cannot be edited.

Field	Description
Release Version	The version name or number of this release.
Status	Select Active from this dropdown list to display the name in the Release dropdown list. Inactive records will only show in the list view of this page.
Order	Enter a number to specify the order in which the release is displayed in the dropdown list. Numbers can be repeated in this field, so they can either be ranked in order (1,2,3...), in order of importance (1,1,1,2,2,2,3,3,3...), or any other ranking that is used internally.

Release Module Tab

The Releases module tab can be accessed by navigating to the Administration page and clicking "Releases" in the Bugs section.

Bugs

Maintain a list of releases for your product. Active releases are displayed in the Releases drop-down menus in bug records created within the Bug Tracker module.



Once in the Releases list view, you can click the triangle in the Releases module tab to display the Actions menu, which allows you to perform important actions within the module. Please note that clicking the module tab only allows you to access the Releases list view.

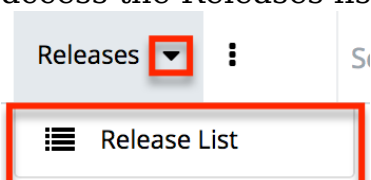

Creating Releases

Releases can only be created from the Releases module. Use the following steps to

create a release option for dropdown lists:

1. Navigate to Admin > Releases.
2. Click the Create button above the Releases list view.

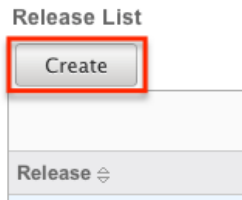

3. An editable subpanel will open below the list view. Enter the required information on the fields provided.

The screenshot shows the 'Release: 1.0' edit form. It has two buttons: 'Save' and 'Save & Create New'. Below the buttons are three fields: 'Release version: *' with the value '1.0', 'Status: *' with a dropdown menu set to 'Active', and 'Order: *' with the value '2'. The 'Status' dropdown has a tooltip that says 'Set status to Inactive to remove this release from the Release dropdown lists'. The 'Order' field has a tooltip that says 'Set the order this release will appear in the Release dropdown lists'.

4. Click one of your two save options. Both will store your new record and have it available for use through Sugar. However, the behavior after clicking is dependent on which button used:
 - **Save** : After clicking "Save", the same release option that you created will remain editable for you to make additional changes if need be, after appearing on the list view above.
 - **Save & Create New** : After clicking "Save & Create New", the release appears on the list view, the edit form's "Release Version" field is cleared out, and the "Order" field is increased by one.

The screenshot shows the 'Release:' edit form. It has two buttons: 'Save' and 'Save & Create New'. Below the buttons are three fields: 'Release version: *' which is empty, 'Status: *' with a dropdown menu set to 'Active' and a 'Set' button, and 'Order: *' with the value '5' and a 'Set the' label.

Viewing Releases

All of the release options are shown on a list view in the Releases module. Due to the Releases module only containing three fields, all of the necessary details are shown on this list view. The list view is always available when viewing the Releases module, and specific releases can be selected from the list, but records can also be selected via the Recently Viewed section of the module tab.

Viewing Via Module

To view all of the releases, navigate to Admin > Releases. The list view displays with all currently available releases within Sugar. The list view can be ordered by any of the three [fields](#) within Releases. To see additional releases, use the arrows in the top right of the list view to scroll through available pages. Here, you can see which records of the total amount of releases are currently being displayed. The two single-arrow Next and Previous buttons can be used to scroll through the records page-by-page. The two double-arrow First Page and Last Page buttons allow you to skip to the beginning or the end of the list.

From this list, any of the releases can be clicked and either [edited](#) or [deleted](#).

Release List

Release	Status	Order	
1.0	Active	2	delete

Editing Releases

Changes to releases can be made at the discretion of any admin at any time. To make changes, such as changing the name of the release and how it shows in the Bugs module, whether the release value is active or not, or the order in which the releases display, the release record needs to just be accessed via the list view. Follow these steps to edit releases:

1. Navigate to Admin > Releases.
2. Select the release that you would like to edit by clicking the release name.

Release	Status	Order	
1.0	Active	1	delete
2.0	Active	2	delete
2.5	Active	3	delete
3.0	Active	4	delete

3. This will open the editor below the list view for the specific record where you can make the necessary changes.

Save Save & Create New

Release version: * 1.0

Status: * Inactive Set status to Inactive to remove this release from the Release dropdown lists



Order: * 1 Set the order this release will appear in the Release dropdown lists

- Click one of your two save options. Both will store your updates to the record. However, the behavior after clicking is dependent on which button used:
 - Save** : After clicking "Save", the same release option that you edited will remain editable for you to make additional changes if need be, after the changes update on the list view above.
 - Save & Create New** : After clicking "Save & Create New", the changes to the release appear on the list view, the edit form defaults back to [creating a new record](#).

Deleting Releases

If a release option is invalid or should no longer appear in your organization's Sugar instance, it may be deleted from the Releases list view. Deleting release options will not delete the bugs that use them. Instead, if a bug's "Found in Release" or "Fixed in Release" field was filled in with the deleted release, the field will now be blank. Use the following steps to delete a release option from the Bugs module:

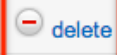
- Navigate to Admin > Releases.
- Click the Delete button corresponding to the release that you would like deleted.

Release	Status	Order	
1.0	Inactive	1	 delete
2.0	Active	2	 delete
3.0	Active	4	 delete

The page will refresh and the option will now be removed from the list view and no longer appear in the dropdown fields (e.g. Found in Release).

Last Modified: 2019-12-05 15:47:53

SugarBPM

Overview

SugarBPM™ enables administrators to streamline common business processes by managing approvals, sales processes, call triaging, and more. SugarBPM is an easy-to-use business process management (BPM) and workflow tool that adds advanced BPM functionality to Sugar.

Note: SugarBPM™ is not available in Sugar Professional.

The SugarBPM suite features an extensive toolbox of modules that provide the ability to easily create digital forms and map out robust workflows using a drag-and-drop interface.

Scope

This documentation only defines relevant BPM terminology and the concepts used specifically for SugarBPM modules. It is not intended for general BPM educational purposes, and should not be used as a complete BPM modeling resource.

The SugarBPM documentation contains the following pages:

- SugarBPM™ (current page)
- [Process Definitions](#)
- [Process Business Rules](#)
- [Process Email Templates](#)
- [Stock SugarBPM Templates](#)

Additionally, the [Processes](#) page of the Application Guide contains documentation for the user-facing elements of SugarBPM, and the [Knowledge Base](#) contains several business use-case tutorials on how to design some common processes for your organization.

Prerequisites

- Basic knowledge of process design is required.
- Basic knowledge of process standards such as BPMN is preferred. BPMN is a flowchart-based notation used to define business processes within an organization.
- You should know which business processes you want to automate in Sugar.

Core Concepts

A business process is a set of logically related tasks that are performed in order to achieve a specific organizational goal. It presents all of the tasks that must be completed in a simplified and streamlined format. SugarBPM empowers Sugar administrators to automate vital business processes for their organization. Some examples of business processes that can be automated using SugarBPM include invoice approvals, lead routing, customer service case routing, and automated reminders and escalations.

SugarBPM Modules

In order to seamlessly automate business processes, the SugarBPM suite leverages four interconnected process-related modules. The [Process Business Rules](#) module and the [Process Email Templates](#) module are used to create rules and email templates that will be referenced by records created in the [Process Definitions](#) module. Once a process definition has been created, it will generate a record in the [Processes](#) module each time the process definition is triggered.

The Process Business Rules, Process Email Templates, and Process Definitions modules can be viewed and configured by any system administrator user. In addition, regular users with a role that provides developer access to one or more modules will be able to access all SugarBPM functions for those modules. Regular users without developer role permissions will only have access to the Processes module. For more information about roles, please review the [Role Management](#) documentation.

The following image illustrates the relationship between the SugarBPM modules:

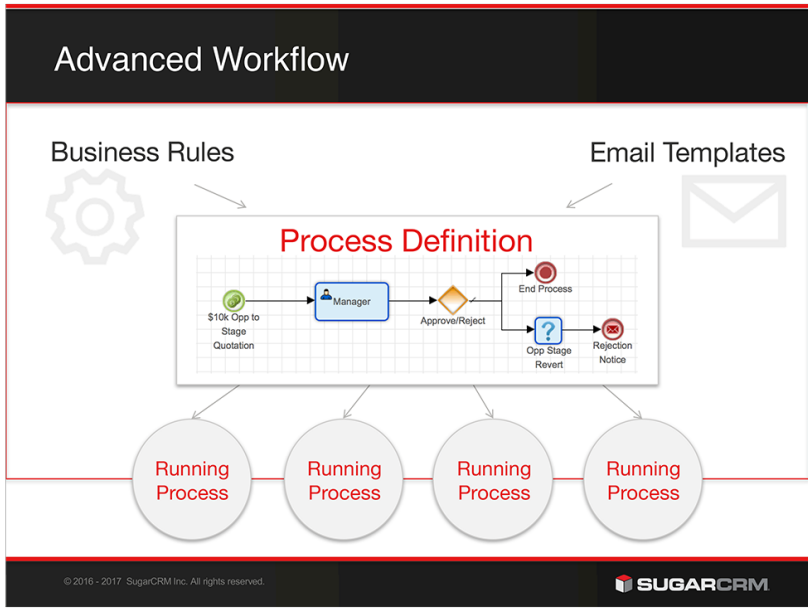

The following table describes the four SugarBPM modules and their intended use. To learn more about any of the modules, click on the hyperlinked module name.

Note: We recommend reading this page in its entirety before moving on to other SugarBPM sections.

Module	Description
Process Definitions	<p>A process definition defines the steps in an overall business process. Process definitions are created by a Sugar administrator. The process definition consists of a network of activities and their relationships, criteria to indicate the start and end of the process, and information about the individual activities (e.g., participants) contained within the business process.</p>
Processes	<p>A process is a running instance of a process definition. A single process begins every time a process definition is executed. For example, a single process definition could be created to automate quote approvals, but because users may engage in several quote approvals per day, each approval will be represented by a separate process instance, all governed by the single process</p>

definition. In other words, the Processes module is the many-to-one (M:1) child module of Process Definitions.

The Processes module is the only SugarBPM module that is visible to regular users. From the Processes dashlet and module list view, they will be able to see running processes if there is anything for them to approve, reject, or review.

There are three ways an administrator can view a list of processes:

- **Processes module list view :** List views for the Processes module display processes that require the logged-in user to take approve, reject, or review action. Admin users, like regular users, will only see the processes that are waiting for them. List views can be accessed by navigating to Processes > View Processes.
- [Processes dashlet](#) : This dashlet displays processes that require the logged-in user to take approve, reject, or review action. Admin users, like regular users, will only see the processes that they need to act upon.
- [Process Management page](#) : This is the one place in Sugar where an administrator can see all running, cancelled, and completed processes. From the Process Management page, the admin can also monitor process status, reassign or cancel an in-progress process, or repair processes in an error state. The Process Management page is accessible via the Admin > SugarBPM panel or via the



	Processes module tab by clicking on "Process Management".
Process Business Rules	A process business rule is a reusable set of conditions and outcomes that can be embedded in a process definition. The set of rules may enforce business policy, make a decision, or infer new data from existing data. For example, if Sally manages all business opportunities of \$10,000 or more, and Chris manages all business opportunities under \$10,000, a process business rule can be created and used by all relevant process definitions to ensure that the assignment policy is respected. In the case of an eventual personnel change, only the process business rule will need to be edited to affect all related processes.
Process Email Templates	A process email template is required in order to include a Send Message event in a process definition. Sugar's core product includes several places where email templates can be created for different purposes, but SugarBPM requires all sent messages to be created via the Process Email Templates module.

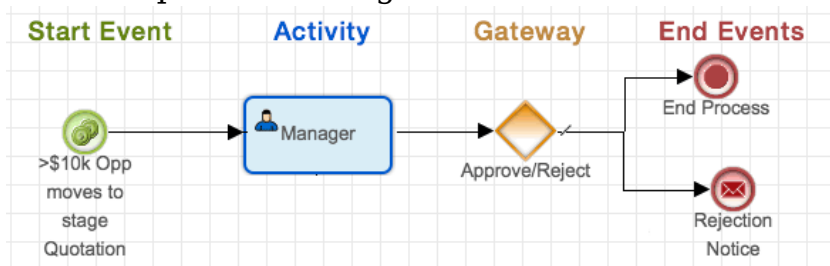

Basic Visual Notation Elements

SugarBPM depends on process definitions created by the administrator using a Visual Designer tool. When complete, the design will graphically display a collection of flow elements that connect with each other to define and regulate a business process in Sugar.



The following table defines the different types of flow elements that are available when creating a process definition in the Visual Designer.

Element	Symbol	Definition
Events		<p>An Event is something that happens during the course of a business process. Events affect the flow of the Process and usually have a trigger and/or a result. They can start, interrupt, or end the flow of a process.</p> <p>An Event is represented by a circle in the Visual Designer.</p>
Start Events		<p>The Start event indicates where a process will begin. It defines the action that will trigger the Process. The Start event will always be triggered by a record in the Sugar module selected as the process definition's Target Module.</p> <p>Note: A process definition's target module will be the same module that is used for the Start event.</p> <p>A Start event is represented by a green circle on the Visual Designer canvas.</p>
Intermediate Events		<p>As the name suggests, Intermediate events occur after a process starts but before the process is complete. Intermediate events that are placed within the overall process</p>

		<p>flow represent things that happen during the normal operation of the process such as sending messages, receiving messages, or mandatory waiting periods.</p> <p>Intermediate events are represented by blue circles in the Visual Designer.</p>
<p>Activities</p>		<p>The only unit of work that may require a user response (opposed to automation) is an Activity. It is a moment within a flow where a user must decide if a circumstance is approved or rejected, or review a record that has been routed to them.</p> <p>Activities are represented by rounded-corner rectangles in the Visual Designer.</p>
<p>Actions</p>		<p>Actions are automated elements used to execute a business rule, create or update a Sugar record, or identify a process user. Actions are completed by the SugarBPM engine and do not require any human interaction to execute.</p> <p>Actions are represented by rounded-corner squares in the Visual Designer.</p>
<p>Gateways</p>		<p>Gateway elements are used to control the flow of a process via merging and splitting. When several</p>

		<p>activities may result in a common outcome, a gateway serves as a merging mechanism, or a "converging" element. When a single activity may result in several different outcomes, a gateway serves as a splitting mechanism, or a "diverging" element.</p> <p>A Gateway is represented by a diamond in the Visual Designer.</p>
<p>End Events</p>		<p>End events signal completion of a process. There are three end-event options: Do Nothing, Terminate Process, or Send Message. An End event is represented by a red circle in the Visual Designer.</p>

Basic Steps to Automate a Business Process

It is important to understand how all of the modules and elements of the SugarBPM suite will work together. Here is the best-practice chronology of the overall procedure for automating business processes in Sugar using SugarBPM:

1. [Create a SugarBPM Dashboard](#) : Before using SugarBPM for the first time, create a new dashboard specific to SugarBPM for easy, one-stop access to all automated business processes and their components.
2. [Create and Configure a Process Business Rule](#): (optional) Create at least one Process Business Rule that will be used in a process definition. For example, automated lead assignments might require a process business rule to define which lead source values will be assigned to which user.
3. [Create and Configure a Process Email Template](#) : (optional) Prepare at least one Process Email Template for processes that require alerts or notifications.
4. [Create and Configure a Process Definition](#): Using the Process Designer canvas, create the visual design of the overall business process that you

want to automate. The process definition may make use of Process Business Rules and Process Email Templates created in previous steps.

5. [Process Management](#) : With all of the SugarBPM modules now working in harmony, administrators can navigate to the Process Management page to monitor process status, reassign or cancel an in-progress process, or repair processes in an error state. Users can monitor the [Processes dashlet](#) for activities that are queued or awaiting feedback.

Creating a SugarBPM Dashboard

Before getting started, we recommend that the administrator user creates a SugarBPM-specific dashboard on their home page. This will allow the administrator to easily manage Process Definitions and their supporting modules all in one place. Regular users who may be engaged in running processes should place the [Processes dashlet](#) on their home pages to stay abreast of activities requiring their attention.

The screenshot displays the 'Advanced Workflow Dashboard' interface. At the top, there is a navigation bar with tabs for 'Accounts', 'Contacts', 'Opportunities', and 'Leads', along with a search bar and a notification bell icon showing '1' notification. The dashboard itself is divided into four main sections:

- Processes:** Features a 'Current' tab and an 'Overdue' tab. It shows '1 My Processes' and '0 Self Service Processes'. A process entry is visible: 'Process # 4 - Leak in water pipe' created by Administrator a few seconds ago, with an 'Escalate to Mgr Case Escalation' due in an hour.
- Process Definitions:** Features a 'My Process Definitions' tab and an 'All Process Definitions' tab. It shows '3 Enabled' and '0 Disabled' definitions. Three definitions are listed: 'Idle Account Send Message' (created 41 minutes ago), 'Case Escalation' (created an hour ago), and 'New Account Processing' (created an hour ago).
- Process Business Rules:** Features a 'My Process Business Rules' tab and an 'All Process Business Rules' tab. It shows '1 Process Business Rules Single Hit'. A rule is listed: 'Lead Routing Country' (created an hour ago).
- Process Email Templates:** Features a 'My Process Email Templates' tab and an 'All Process Email Templates' tab. It shows '1 Process Email Templates'. A template is listed: 'New Account Welcome Email' (created 41 minutes ago).

Processes Dashlet

This is the only SugarBPM dashlet available to regular users. It is important for all users who may be engaged in a process to place this dashlet on their home screens. Open, running processes and self-service processes waiting to be acted upon by the logged-in user will be listed in this dashlet.

Note: Users (including administrators) will see only the processes that immediately require their attention.

To add a Processes dashlet, please refer to the [Dashboards and Dashlets](#) documentation, choosing "Processes" from the Add a Dashlet page.



After saving the dashlet and its containing dashboard, the dashlet will offer several process-specific management tools:

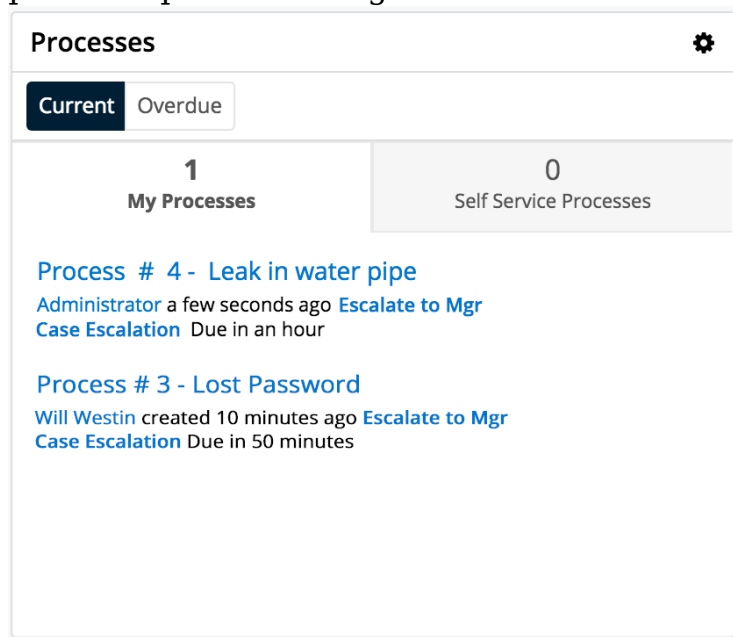

- **Current** : Click on this button to view all processes that are running within the expected timeframe.
- **Overdue** : Click on this button to view all processes that have a due date in the past. The label "Overdue" and the due date will be displayed adjacent to the process description.
- **My Processes** : View this tab to view the running processes upon which the logged-in user must act. Self-Service processes are not displayed here.
 - To execute a Process from the dashlet, click on the name of the process. Please note that admin users cannot see processes running

for other users via the dashlet. To access the system's exhaustive list of running and completed processes, refer to the [Process Management](#) section of this documentation.

- **Self Service Processes** : View this tab to view only the running processes in the queue to be claimed by a user. Self-Service processes are configured inside the User Activity element settings of the related process definition.
- **Process Description** : Running processes are displayed in list view format with descriptive fields including the unique process number, the name of the affected Sugar record, the process title, the responsible user's name, and the label of the relevant process step.
- **Due Date** : When a due date exists it will appear adjacent to the process description.

Process Definitions Dashlet

You must be an administrator user to add this dashlet to your home page. To add a Process Definitions dashlet, please refer to the [Adding Dashlets](#) section of the Intelligence Pane documentation, choosing "Process Definitions" from the Add a Dashlet page.

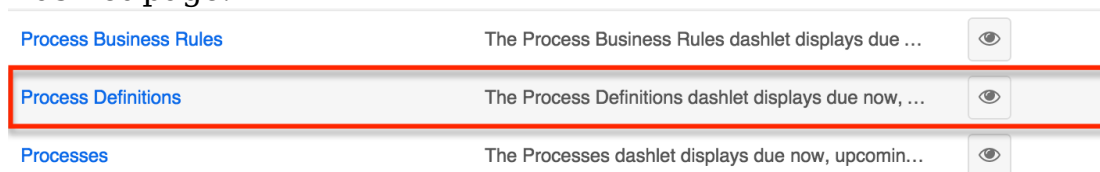

After saving the dashlet and its containing dashboard, the dashlet will offer several SugarBPM-specific administration tools:

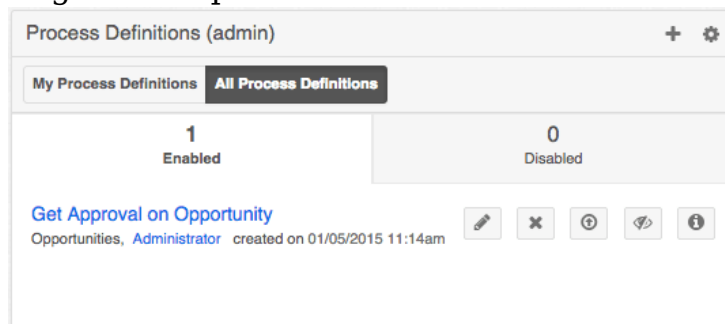

- **Actions Menu** : Click on the plus (+) icon to access the "Create Process Definitions" and "Import Process Definitions" options. Please note that imports for this module must have a .bpm file extension.

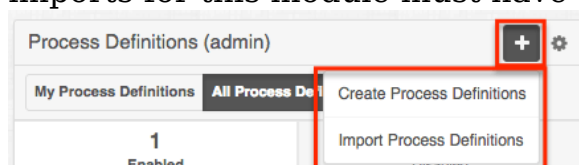

- **My Process Definitions** : Click on this button to list all process definitions created by the current admin user.
- **All Process Definitions** : Click on this button to list all process definitions created by any admin user.
- **Enabled** : View this tab to view a list of process definitions that are currently enabled in the system.
- **Disabled** : View this tab to view a list of process definitions that are currently disabled in the system. Disabling a process definition will prevent it from triggering new processes. Any running processes related to the disabled process definition will pause in an In-Progress state until the process definition is re-enabled.

- **Process Definition Shortcut Buttons**

- **Design** : Click on this icon to edit the process definition via the Visual Designer.



Design

- **Delete** : Click on this icon to delete the adjacent process definition. A confirmation message will appear on the top of the screen; click "Confirm" to delete the process definition or click "Cancel" to close the message without deleting.



Delete

- **Export** : Click on this icon to export the process definition to a .bpm file.



Export

- **Disable/Enable** : Click on this icon to disable an active process definition or to enable an inactive one. Disabled process definitions will be listed in the "Disabled" tab.
 - All process definitions are disabled by default and must be enabled by an administrator. For more information, please refer to [Enabling Process Definitions](#).
 - Disabling a process definition will prevent it from triggering new processes. Any running processes related to the disabled process definition will pause in an In-Progress state until the process definition is re-enabled.



Disable

- **Description** : Click this icon to open a blue alert window that displays the admin-specified description of the process definition. To close the description dialogue, click on the x in the corner of the

message.

Advanced Workflow Dashboard

Process Definitions

My Process Definitions All Process Definitions

3 Enabled 0 Disabled

New Account Processing
Accounts, Administrator created 20 hours ago

Processes

Current Overdue

0 My Processes

No data

Description

Process Email Templates Dashlet

You must be an administrator user to add this dashlet to your home page. To add a Process Email Templates dashlet, please refer to the [Adding Dashlets](#) section of the Intelligence Pane documentation, choosing "Process Email Templates" from the Add a Dashlet page.

Process Email Templates Process Email Templates dashlet displays the te...

Processes Processes dashlet displays the templates that ca...

After saving the dashlet and its containing dashboard, the dashlet will offer several SugarBPM-specific administration tools:

Process Email Templates (admin)

My Process Email Templates All Process Email Templates

4 Process Email Templates

Account referencing Contact
Accounts, Administrator created on 01/09/2015 5:10pm

Purchase Confirmation to Customer
Opportunities, Administrator created on 01/09/2015 1:34pm

Quote Approval Message
Quotes, Administrator created on 01/08/2015 7:21 pm

Quote Rejection Message
Quotes, Administrator created on 01/08/2015 6:22pm

- **Actions Menu** : Click on the plus (+) icon to access the "Create Process Email Template" shortcut.

Process Email Templates (admin)

My Process Email Templates All

Create Process Email Template

Import Process Email Templates

- **My Process Email Templates** : Click on this button to list all email templates created by the current admin user.
- **All Process Email Templates** : Click on this button to list all email templates created by any admin user.
- **Process Email Template Shortcut Buttons**
 - **Edit** : Click on this icon to edit the template record from record view. It is then possible to access the template designer from the record view.



Edit

- **Delete** : Click on this icon to delete the adjacent email template. A confirmation message will appear on the top of the screen; click "Confirm" to delete the email template or click "Cancel" to close the message without deleting.



Delete

- **Export** : Click on this icon to export the process email template to a .pet file.



Export

- **Description** : Click this icon to open a blue alert window that displays the admin-specified description of the process email template. To close the description dialogue, click on the X in the corner of the message.



Description

Process Business Rules Dashlet

You must be an administrator user to add this dashlet to your home page. To add a Process Business Rules dashlet, please refer to the [Adding Dashlets](#) section of the Intelligence Pane documentation, choosing "Process Business Rules" from the Add a Dashlet page.

Process Business Rules	The Process Business Rules dash...	
Process Definitions	The Process Definitions dashlet dis...	

After saving the dashlet and its containing dashboard, the dashlet will offer several SugarBPM-specific administration tools:

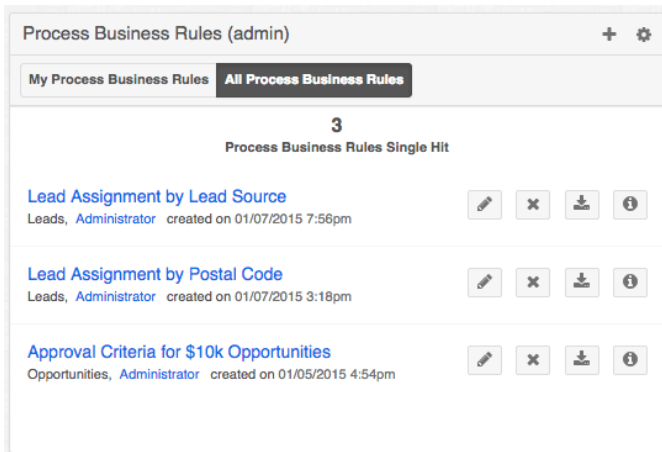

- **Actions Menu** : Click on the plus (+) icon to access the "Create Process Business Rule" shortcut.

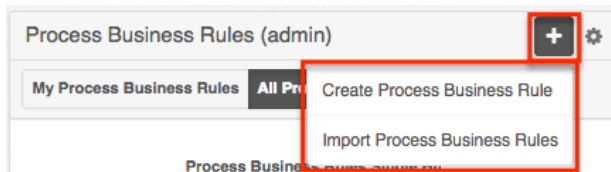

- **My Process Business Rules** : Click on this button to view business rules created by the logged-in admin user.
- **All Process Business Rules** : Click on this button to view business rules created by any admin user.
- **Business Rules Shortcut Buttons**

- **Edit** : Click on this icon to edit the rule configuration from the Business Rules Builder interface.



Edit

- **Delete** : Click on this option to delete the adjacent business rule. A confirmation message will appear on the top of the screen; click "Confirm" to delete the process business rule or click "Cancel" to close the message without deleting.



Delete

- **Export** : Click on this icon to export the process business rule to a .pbr file.



Export

- **Description** : Click this icon to open a blue alert window that

displays the admin-specified description of the process business rule. To close the description dialogue, click on the X in the corner of the message.

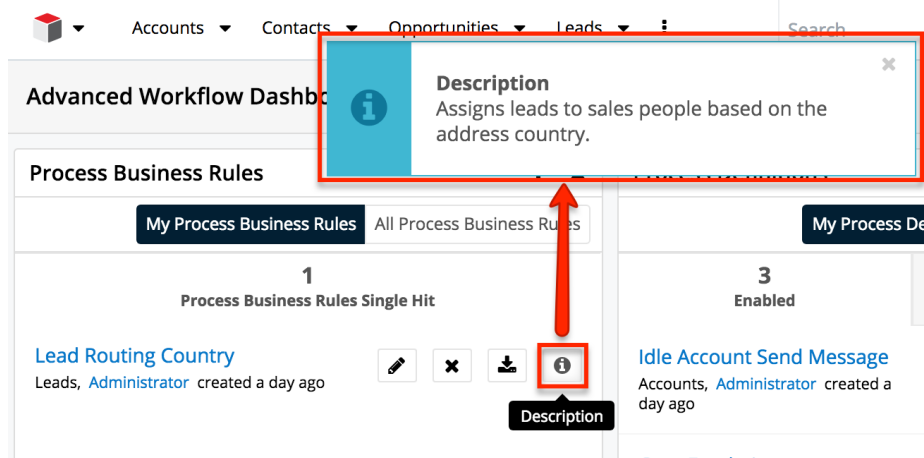

Process Management List View

For processes, the admin user is restricted to the same access as a regular user in the Processes module. This means that in Processes list view and the Processes dashlet, the admin user will not see processes unless they have participated in that process or they are expected to participate in it.

The exhaustive list of open and completed processes is accessible only via the admin's Process Management page. This page can be accessed from either of the following two places in Sugar:

- Admin > SugarBPM™ > Process Management.
- The Processes module tab's actions menu:

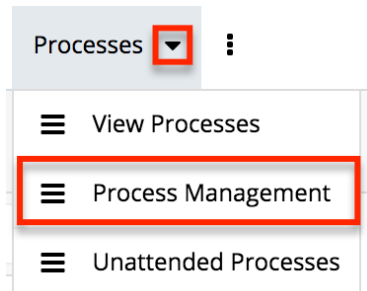

The following columns are available from the Process Management page:

Process Number	Process Definition Name	Record Name	Status	Date Created	Assigned To	Process User	Process Owner
340	Ignored Case Alert	test case	CANCELLED	2015-03-27 19:30	Jen Smith		Jen Smith
339	tasks for use	HotelSeven Mar 27	IN PROGRESS	2015-03-27 17:00	Anwesa Chatterjee		Anwesa Chatterjee
337	Customer Onboarding Tasks	HotelSeven test 001	ERROR	2015-03-27 17:00	Enrique Ponce De Leon		Enrique Ponce De Leon
336	tasks for use	HotelSeven test 001	COMPLETED	2015-03-27 17:00	Enrique Ponce De Leon		Anwesa Chatterjee
338	Customer Success Tasks	HotelSeven test 001	IN PROGRESS	2015-03-27 17:00	Enrique Ponce De Leon	Enrique Ponce De Leon	Enrique Ponce De Leon
335	Customer Stage Decide Tasks	HotelSeven test 001	TERMINATED	2015-03-27 16:56	Enrique Ponce De Leon		Anwesa Chatterjee

- **Process Number** : Similar to a case number, this is a unique auto-increment number assigned to the process in the order it was triggered by the SugarBPM. This field is not related to the Sugar system ID field.
- **Process Definition Name** : The name of the originating process definition that triggered the process.
- **Record Name** : The related Sugar module record to which the process applies.
- **Date Created** : The date and time that the process was triggered.
- **Assigned To** : The user who is assigned to the Sugar record that triggered the process's Start event.
- **Process User** : The user who is responsible for executing the current activity in a running process if a Route or Approval activity is running.
- **Process Owner** : The administrator who created the process definition (not necessarily affiliated with the running process).
- **Status**
 - COMPLETED** : The process has successfully reached an end event and is no longer running.
 - CANCELLED** : An administrator user has chosen to cancel this process.
 - IN PROGRESS** : The process is currently open and running.
 - TERMINATED** : The record that triggered the process has been deleted or merged.
 - ERROR** : The process has encountered a configuration problem and is paused.

Record Actions Menu

The Record Actions menu to the right of each record's Preview button allows users to view vital process information, re-direct processes, and navigate to the process execution screen directly from the list view.

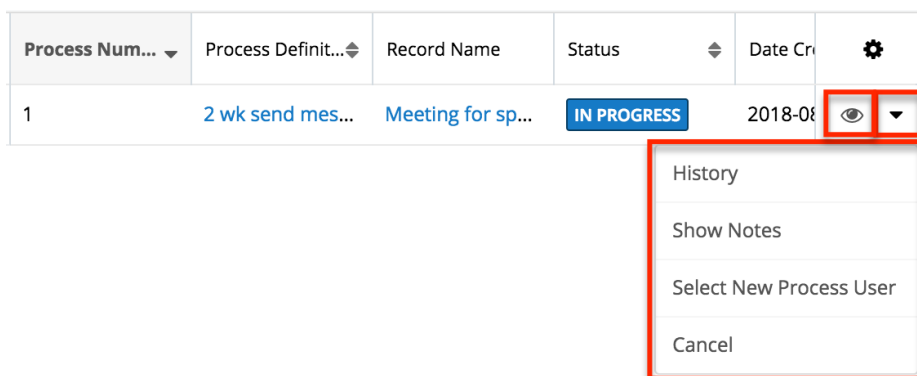

Menu Item	Description
Preview (eye icon)	See an image of the current process and how it has progressed within the overall flow.
History	Launch the Process History window, which provides a historical summary of the process's lifecycle.
Show Notes	Display user-created comments and add your own.
Select New Process User	Display all of the process users who have engaged with the process and, optionally, reassign its current activity to a new process user. To reassign the process after clicking this option, select a new value for the "Process User" field and then click "Done".
Execute	Available only for processes in an Error state, the "Execute" option allows an administrator to re-commence the flow of a process that has been stopped due to an error. This option should only be used after the condition that caused the error has been corrected.
Cancel	Terminate the process occurrence.

Preview

Administrators can view the progression of a process within the overall flow directly from the Processes list view by clicking the Preview icon to the far right of each process list row. A color-coded representation of the process' design layout

will display to the right of the list view providing key information regarding the stages that have already been completed, the current stage of the process, and the stages that have yet to execute.

The executed and in-progress stages of the process will be displayed in color, while skipped or not-yet-executed stages will be presented in a grayed out style.

The screenshot shows the 'Process Management' interface. On the left is a table with columns: Process Number, Process Definition Name, Record Name, Status, and Date Created. The 'Status' column contains buttons for 'IN PROGRESS' (blue) and 'ERROR' (red). An eye icon in the rightmost column of the table is highlighted with a red box, and a red arrow points from it to a 'Process design Preview' window on the right. This window shows a complex flowchart with various steps, decision diamonds, and task boxes. At the top right of the preview window, there are navigation arrows and a close 'X' button, all enclosed in a red box.

Process Number	Process Definition Name	Record Name	Status	Date Created
13	Re-route idle cases	Warning message ...	IN PROGRESS	2015-02-08 15:27
12	Re-route idle cases	Warning message ...	IN PROGRESS	2015-02-08 15:08
6	Discount Approval Proc...	Underwater Partne...	ERROR	2015-02-04 20:42
15	Re-route idle cases	System not respon...	IN PROGRESS	2015-02-08 15:28
11	Case Approval	Send user's manual	IN PROGRESS	2015-02-06 15:23
3	Discount Approval Proc...	Process Quote	ERROR	2015-02-04 19:56
10	Case Approval	Needs spare parts	IN PROGRESS	2015-02-06 15:22

Note: To view the process design layout in more detail, simply click on the preview image to open a full-sized version of the flow in a new browser tab.

On the upper right of the intelligence pane, there is a Left and Right arrow button that allows you to scroll through the list view's current search results by previewing the next or previous record. To close the preview, simply click the "X" on the upper right of the intelligence pane.

Searching Processes

The Process Management list view includes a module search to help you locate running, completed, and incomplete processes easily and effectively. Once the search is performed, the relevant results will be displayed in the list view below.

Unlike the standard Sugar filter, the Process Management search bar will query all Process fields by default with the exception of "Record Name", which is technically a field from a related module. Furthermore, Sugar automatically assumes a wildcard character (%) at both the beginning and the end of your search phrase for processes. This means that, for example, a search for "error" will return processes named "Approve Error Resolution" as well as processes that are in an "Error" status.

Process Management					
Fields ▾ All error					
Process Number	Process Definition Name	Record Name	Status	Date Created	
18	Approve Error Resolution	5000 Unit Sale	IN PROGRESS	2015-02-10 13:07	
6	Discount Approval Process	Underwater Partnership	ERROR	2015-02-04 20:42	

The search also provides a Filter option that can be used in combination with the open Search box to narrow your search further using the available options as follows:

- **All** : Returns all processes.
- **Processes Completed** : Returns only processes with a status of "Completed".
- **Processes Terminated** : Returns only processes with a status of "Terminated".
- **Processes In Progress** : Returns only processes with a status of "In Progress".
- **Processes Cancelled** : Returns only processes with a status of "Cancelled".
- **Processes Error** : Returns only processes with a status of "Error".

Filter ▾ All Search...					
Process Definition Name	Record Name	Status	Date Created	Assigned User	
route idle cases	Having trouble addin...	IN PROGRESS	2015-02-08 17:11	Loohu	👁️ ▾
route idle cases	Having trouble addin...	COMPLETED	2015-02-08 15:35	Loohu	👁️ ▾
route idle cases	System not responding	IN PROGRESS	2015-02-08 15:28	Loohu	👁️ ▾
route idle cases	Need assistance wit...	IN PROGRESS	2015-02-08 15:28	Loohu	👁️ ▾
route idle cases	Warning message w...	IN PROGRESS	2015-02-08 15:27	Loohu	👁️ ▾
route idle cases	Warning message w...	IN PROGRESS	2015-02-08 15:08	Loohu	👁️ ▾

When you choose a filter, Sugar will return processes that match both the selected filter and any name provided in the "Search..." bar in the filtered list view results. For example, if you select "Processes Completed" in the Filter options and enter a search query, Sugar will only return processes that contain a match to the search query and have a Completed status. To see all processes, simply select "All" in the filter and remove any text from the search bar. You can also click the X that appears within the search bar. When you run a search using a saved filter, the search will not be preserved when you navigate away from the module. Returning to the Process Management page will automatically display all unfiltered results.

Unattended Processes

An unattended process is a running process instance that has been interrupted because an activity is dependent upon the response of an inactive or deleted user. If an activity is encountered within a process, and the activity's process user record's status is "Deleted" or "Inactive" or its employee status is "Not Active", the process will be considered unattended. The activity cannot be completed unless the administrator designates a new process user.

Note: While an unattended process will also appear in the [Process Management](#) list, its status will remain "In Progress" and will not indicate that it is in an unattended state.

The list of unattended processes is accessible via the admin's Unattended Processes page. This page can only be accessed from the Processes module tab's actions menu:

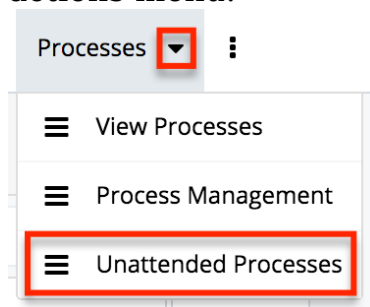

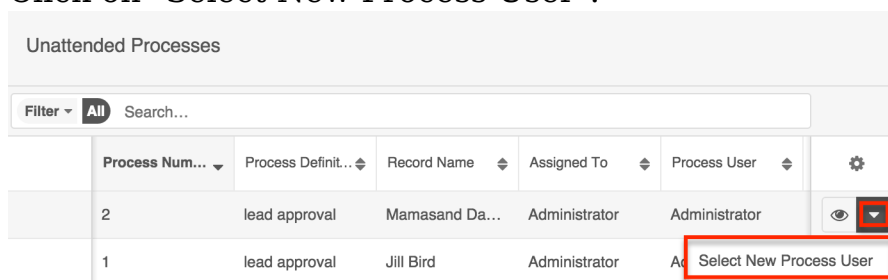

To select a new process user for an unattended process, follow these steps:

1. From the Unattended Processes list view, expand the actions menu for the row that contains the unattended process.
2. Click on "Select New Process User".



The image shows a screenshot of the 'Unattended Processes' list view. The table has columns for Process Num..., Process Definit..., Record Name, Assigned To, and Process User. The first row has Process Num... 2, Process Definit... lead approval, Record Name Mamasand Da..., Assigned To Administrator, and Process User Administrator. The second row has Process Num... 1, Process Definit... lead approval, Record Name Jill Bird, Assigned To Administrator, and Process User Administrator. A red box highlights the 'Select New Process User' button in the actions menu for the second row.

Process Num...	Process Definit...	Record Name	Assigned To	Process User	
2	lead approval	Mamasand Da...	Administrator	Administrator	 
1	lead approval	Jill Bird	Administrator	Administrator	

3. After a brief pause, the Select New Process User widget will appear.

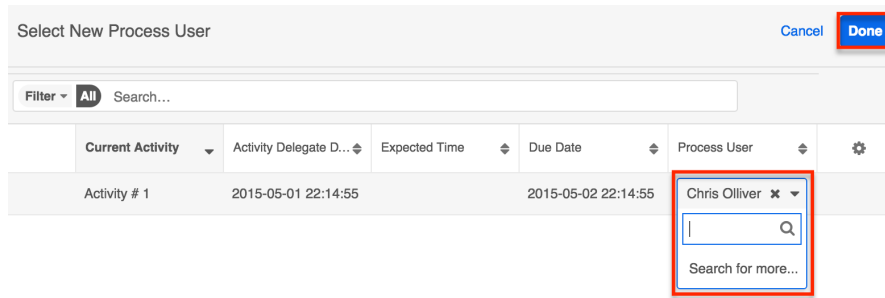

4. Find and select the name of the new process user and then click Done.

The updated process should no longer be visible in the Unattended Processes list, and the new process user will see the activity in their Processes dashlet and list view.

Terminated vs. Cancelled Processes

SugarBPM automatically terminates a process when the record related to the process' Start event is deleted. The associated process will be removed from the Processes dashlet and the process record will display "Terminated" in the Status column of the Process Management list view. Processes may also be terminated as a result of meeting conditions specified in the Process Termination settings. For more information, please refer to the [Process Definitions](#) documentation.

Cancelled processes, on the other hand, have been intentionally stopped by the administrator. The associated process will be removed from the Processes dashlet and the process record will display "Cancelled" in the Status column of the Process Management list view.

Importing and Exporting SugarBPM Module Records

SugarBPM supports import/export functionality for records in all modules except the Processes module, which only contains running instances of process definitions. To import records into the Process Definitions, Process Email Templates, or Process Business Rules modules, the import file must be formatted as the appropriate proprietary file type, as shown in the table below.

SugarBPM Module	Supported File Extension
Process Definitions	.bpm
Process Email Templates	.pet
Process Business Rules	.pbr

Note: The .bpm file type is a package that may include email templates and

business rules that are related to the process definition. Process email templates and process business rules, when exported or imported on their own, will have the .pet and .pbr file extensions, respectively. More information is available in the [Exporting](#) and [Importing SugarBPM Records](#) sections below.

Due to the proprietary nature of the SugarBPM file types, only files that have been exported from a Sugar instance can be imported into a Sugar instance. For example, an administrator may choose to design process definitions in a sandbox or development instance before moving them to a production environment. For this, the process definitions would be exported from the dev instance as .bpm files and then imported into the production instance's Process Definitions module.

Note: Please refer to the article [Exporting and Importing a Process Definition](#) for important notes about version compatibility for SugarBPM imports.

Exporting SugarBPM Records

Exported SugarBPM records will automatically download as the appropriate file type. If a process definition uses any email templates or business rules, then the related records will automatically be included as part of the exported process definition's .bpm file. Any tags applied to the SugarBPM records in the .bpm file will also be retained. The user who later imports the process definition will be prompted to decide which supporting files they want to import with the process definition. The process definition and related email template(s) and business rule(s) will be created in their respective modules. More information is available in the [Importing SugarBPM Records](#) section below.

SugarBPM module records can be exported from any of the following locations:

- The record's list view actions menu:

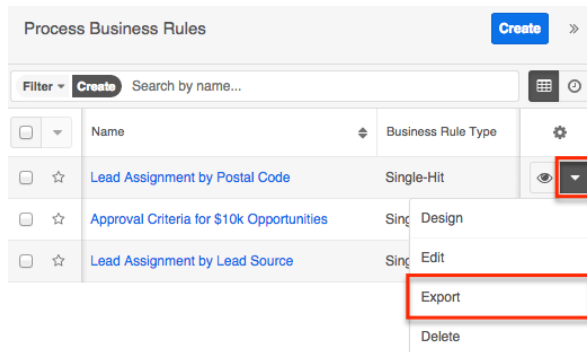

- The module's mass actions menu:

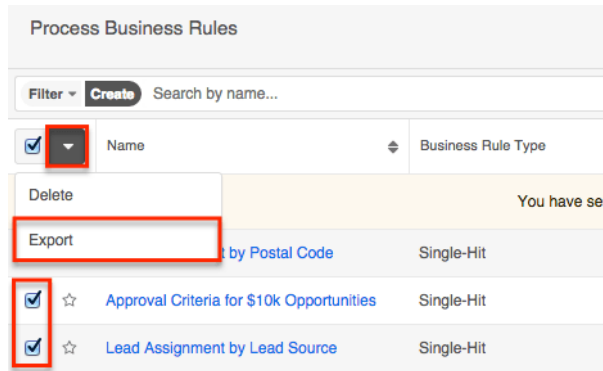

- The record's record view actions menu:

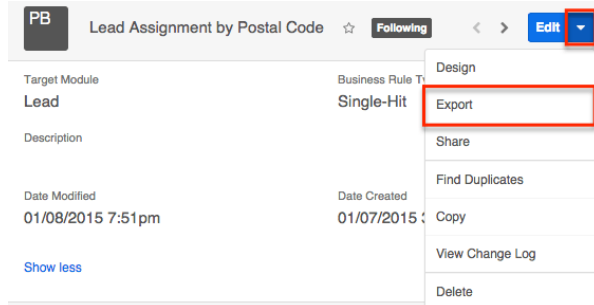

- The dashlet's Export button adjacent to the record:

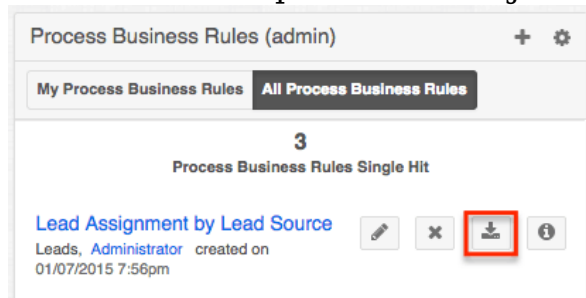

Importing SugarBPM Records

You can import a business rule (.pbr), an email template (.pet), or a process definition (.bpm) that has been exported from another Sugar instance. Most often, this action is performed between a production and development instance for testing or debugging.

Note: By default, Sugar will automatically validate imported process definitions, but you may disable this feature via Admin > [System Settings](#).

After [exporting a SugarBPM module record](#), it can be imported via the option in one of the following menus:

- The Actions menu on the module's dashlet:

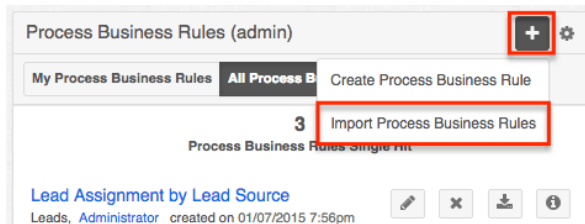

- The module tab's Actions menu:

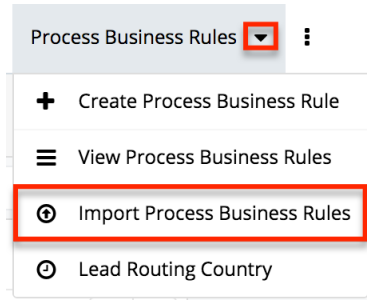

When importing a process definition record, if the .bpm file was exported with related email templates and business rules, you will see a list of those records and be given the option to import them as well. Select the checkbox next to the record type (e.g. Business Rules) to import all of the records in that category. To select related records individually, enable only the checkboxes next to those records.

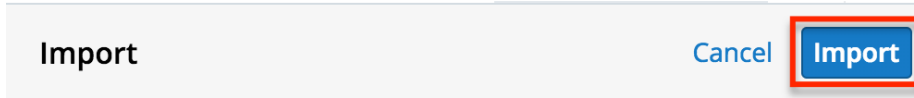

Upload a .bpm file to import a Process Definition.



This Process Definition contains the following Business Rules and Email Templates. Please select the ones you want to import.

Business Rules

US State

Email Templates

Notice for Description Field update

End Event Reached

Click "Import" when you are ready to continue. The process definition and any related email template(s) and business rule(s) will be created in their respective modules and retain their settings and field values, including record-level tags. Please note that the systems that you are exporting and importing between should be clones so that any custom fields, modules, or relationships used by the SugarBPM records can be found.

SugarBPM Settings

To configure SugarBPM settings such as auto-save and auto-validation intervals, navigate to Admin > System Settings and find the SugarBPM™ panel. For more information on the system configuration options for SugarBPM, please refer to the [System](#) documentation.

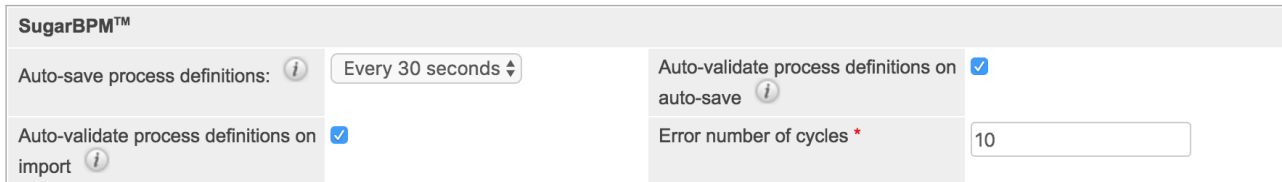

The screenshot shows the SugarBPM™ settings panel. It contains four configuration items: 'Auto-save process definitions' set to 'Every 30 seconds', 'Auto-validate process definitions on auto-save' checked, 'Auto-validate process definitions on import' checked, and 'Error number of cycles' set to '10'.

SugarBPM Log Viewer

Administrators and developers can gain insight into the performance of the SugarBPM engine by viewing the SugarBPM log. To access the SugarBPM Log Viewer, navigate to the Admin page and click on "Log Viewer" under the SugarBPM panel.

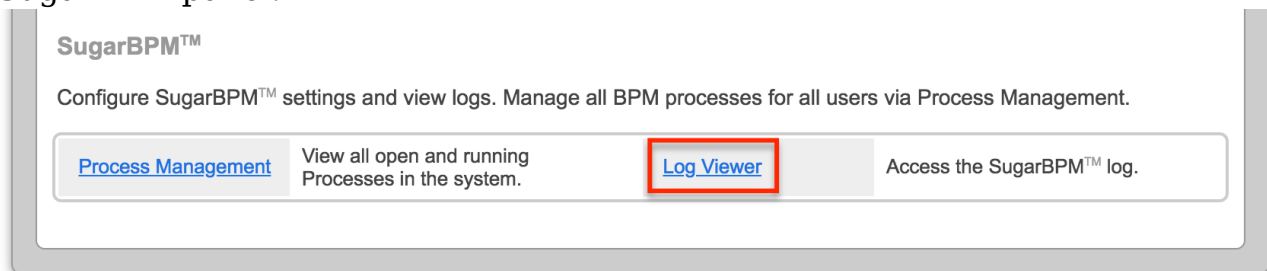

There are two options on the SugarBPM Log Viewer page:

- **Refresh** : Refreshes the log view, loading the last records.
- **Clear** : Permanently deletes all log history. This cannot be undone.

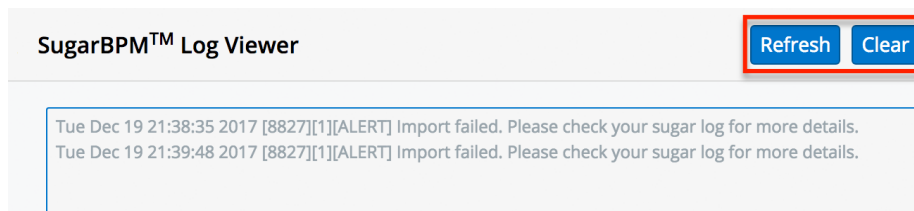

The log level is set to Critical, which is equivalent to Sugar's Fatal log level and starts recording events as soon as SugarBPM has been installed. A developer can update the system config.php to change SugarBPM settings including "logger_level" and "error_timeout". Changes that are made to config.php are

honored in real-time. For more information, please refer to the [Core Settings](#) documentation in the Developer Guide.

SugarBPM Scheduler

Schedulers in Sugar automate the execution of system processes. Schedulers are available only to administrative users and can be accessed by navigating to Admin > Schedulers. SugarBPM Scheduled Job is responsible for processes associated with SugarBPM. It is active and runs as often as possible by default. The SugarBPM Scheduled Job will check for any active, time-based process events (e.g. Wait events, Receive Message events, and Send Message events) in a pending state. If any processes meet this criterion, the scheduler will ensure that the process flow continues.

For more information about Sugar schedulers, please refer to the [Schedulers](#) documentation. For more information on troubleshooting the SugarBPM Scheduled Job, please refer to the [Troubleshooting Wait Events in SugarBPM](#) article.

Note: Process events processed by this scheduler will be run by the admin user (user id = '1') in Process History unless the admin user is disabled.

SugarBPM Blacklisted Fields

As the SugarBPM functionality evolves, certain fields and field types that were available in earlier versions may be prohibited in later versions for data integrity purposes. Please be sure to stay up to date with the [SugarBPM Blacklist](#) for a list of the blacklisted items in SugarBPM modules and the Sugar version in which they were removed.

Last Modified: 2019-12-05 15:47:53

Process Definitions

Overview

The Process Definitions module is one of four modules that make up [SugarBPM™](#), Sugar's business process management tool that enables administrators to

streamline common business processes by managing approvals, sales processes, call triaging, and more. Process definitions are central to the SugarBPM suite. They define the steps in automated business processes and control the flow of work that is allocated during running processes in Sugar. Process definitions are created by a Sugar administrator and consist of a network of activities and their relationships, criteria to indicate the start and end of the process, and information about the individual activities (e.g., participants) contained within the business process.

Before continuing, please read the [SugarBPM](#) overview page, which defines critical vocabulary and other elements that may be referenced on this page.

This documentation contains the following pages:

- [SugarBPM](#)
- Process Definitions (current page)
- [Process Business Rules](#)
- [Process Email Templates](#)
- [Stock SugarBPM Templates](#)

Additionally, the [Processes](#) page of the Application Guide contains documentation for the user-facing elements of SugarBPM. Please note that SugarBPM is not available for Sugar Professional.

The following image illustrates the relationship between all of the SugarBPM modules:

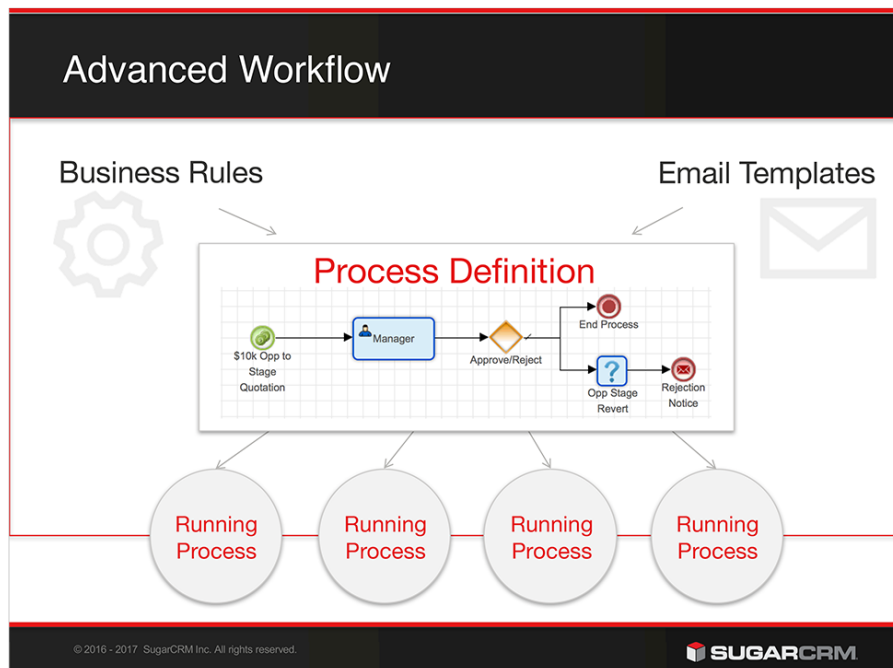

The process definition will be the parent record for countless running processes in Sugar. Every time a process definition's [Start event](#) is triggered, a single process will begin to run in Sugar. When a running process requires action from a user, that user will see the process in their [Processes dashlet](#) and Processes module list view. Users will never see the parent process definition that controls the process, nor will they see any processes for which they are not required to act.

This is an example of a complete process definition created in the [Visual Designer](#):

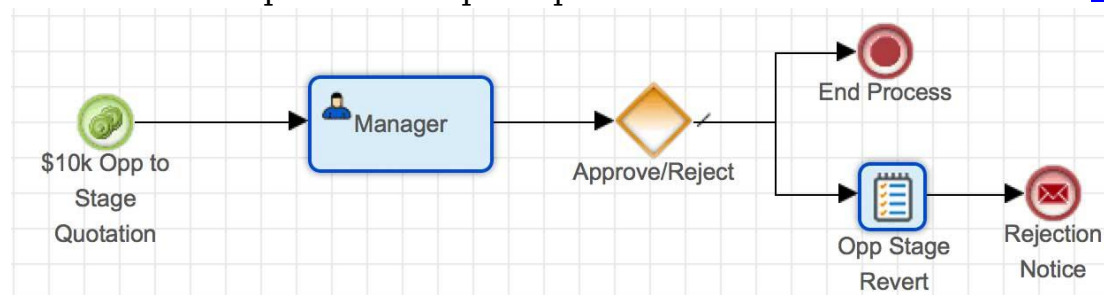

In the example above, the Start event is triggered when a \$10,000+ opportunity moves to stage "Quotation" from any other stage. Every time this condition is met, the process definition will generate a new process instance.

Note: If a process definition will utilize [process business rules](#) or [process email templates](#), those records must be created before designing the process definition. For more information about creating records in these supporting SugarBPM modules, please refer to the corresponding section of the SugarBPM documentation.

Process Definition Fields

The Process Definitions module contains the following fields. For information on using and editing various field types, refer to the [User Interface](#) documentation.

Field	Description
Assigned To	The Sugar user assigned to the process definition
Date Created	The date the process definition record was created
Date Modified	The date the process definition record or its design was last modified
Description	A description or other information about the process definition
Name	A unique and descriptive name

Status	The enabled or disabled state of the process definition
Tags	User-created keywords that can be used to identify records in filters, dashlets, and reports Note: For more information on creating and using tags, please refer to the Tags documentation.
Target Module	The module that will be used for the Start event in the process definition design

Fields Exclusive to Process Definition Design

The following fields are available when designing process definitions targeting the given modules, but are not available in typical module views (e.g. record view) or in Studio. They can be leveraged in your process definitions, but it is important to note that some should only be read and not updated, while others can be updated under certain circumstances. See the sections below for more details.

Field	Module(s)	Description
Contact Source	Contacts	A system-level dropdown field that represents the origin of newly created contacts. Its possible values are Internal and External.
Note Source	Notes	A system-level dropdown field that represents the origin of newly created notes. Its possible values are Internal and External.
Pending Processing	Bugs, Cases, and custom issue-type modules	A system-level checkbox field. Sugar automatically sets the field to true on cases when creating a case via inbound email or relating a case to an inbound email. Sugar does not update it on bugs or other issue-type modules.

Contact Source

The Contact Source field is available on the [Contacts](#) module. It is a system-level dropdown field that represents the origin of newly created contacts. It is set to External on contacts created via Portal and set to Internal on contacts created in Sugar. This field is not available in Studio or the user interface and is only available in SugarBPM. Note that it is intended to be read but not written to in order to preserve the accurate meaning of its value. Therefore, its value can be read in process definitions to determine the source of a contact, but should not be changed.

Note Source

The Note Source field is available on the [Notes](#) module. It is a system-level dropdown field that represents the origin of newly created notes. It is set to External on notes created via Portal and set to Internal on notes created in Sugar. This field is not available in Studio or the user interface and is only available in SugarBPM. Note that it is intended to be read but not written to in order to preserve the accurate meaning of its value. Therefore, its value can be read in process definitions to determine the source of a note, but should not be changed.

Pending Processing

The Pending Processing field is available on the [Bugs](#) and [Cases](#) modules and also on all issue-type modules created in [Module Builder](#). It is a system-level checkbox field. Sugar automatically sets the field to true on cases when creating a case via inbound email or relating a case to an inbound email. Refer to the [Cases](#) documentation for more details on how emails and cases can work together.

In addition to Sugar setting the value of the Pending Processing field on cases, Sugar Serve includes several [stock process definitions](#) that both read and write to the field on cases. If your instance uses these SugarBPM templates to automate customer service processes, do not update the Pending Processing field on cases. Doing so may cause the processes to behave unexpectedly. However, you may still read its value in process definitions without updating the field.

Sugar and the stock SugarBPM templates only use the Pending Processing field on the Cases module and not the Bugs module or other issue-type modules. Therefore, it is safe to leverage the field and make changes to it on bugs and other issue-type modules in SugarBPM (e.g. via process business rules or Change Field events in process definitions).

Note: The Cases and Bugs modules are not available for Sugar Sell users. For more information on license types and the functionality available for each type, refer to the [User Management](#) documentation.

Working With Process Definitions

The following links will open specific sections of the User Interface documentation where you can read about views and actions that are common across most Sidecar modules. The sections following this Working With Process Definitions section describe Process Definition-specific behaviors and functionality.

Content Link	Description
Viewing Process Definitions Viewing via List View Viewing via Record View Viewing via Recently Viewed	The Viewing Records section describes various methods of viewing process definition records, including via the Process Definitions list view and record view, the Recently Viewed menu in the Process Definitions module tab. For information on viewing a process definition's message content, please refer to the Designing Process Definitions section below.
Searching for Process Definitions List View Search Creating a Filter Saving a Filter	The Searching for Records section provides an introduction to list view search, which searches and filters within the Process Definitions module.
Process Definitions List View Total Record Count Create Button List View Search Favorite Designation Column Reordering Column Resizing Column Sorting Column Selection Preview Record Actions Menu More Process Definitions Intelligence Pane	The List View section walks through the many elements of the Process Definitions List View layout which contains a filterable list of all process definition records in Sugar. While the generic menu options are described in the User Interface sections linked to the left, the options specifically available in the Process Definitions list view are described in the List View Record Actions Menu section of this page.
Process Definitions Record View Favorite Designation Next or Previous Record Actions Menu	The Record View section walks through the many elements of the Process Definitions Record View layout which contains detailed information about a

Show More Intelligence Pane	<p>single process definition record. While the generic menu options are described in the User Interface sections linked to the left, the options specifically available in the Process Definitions record view are described in the Record View Actions Menu section of this page.</p>
Editing Process Definitions Editing Inline via Record View Editing via Record View Editing Inline via List View	<p>The Editing Records section describes the methods of editing existing process definition record fields: inline via the Process Definitions record view, in full edit mode on the record view, and inline via the Process Definitions list view. For information on editing a process definition record's content, please refer to the Designing Process Definitions section below.</p>
Deleting Process Definitions Deleting via Record View Deleting via List View	<p>The Deleting Records section describes two ways to delete process definitions: via the Process Definitions record view and via an individual record's Actions menu on the list view.</p>
Favoriting Process Definitions Favoriting via List View Favoriting via Record View	<p>The Favoriting Records section describes the various methods of marking process definitions as favorites, including via the Process Definitions list view and Process Definitions record view. Favoriting a process definition record allows you to easily access it from list views and the Process Definitions module tab.</p>
Sharing Process Definitions	<p>The Sharing Records section provides instructions for the Share record view option which composes an email with a link to the process definition record. If the recipient is logged into Sugar, clicking the link will bring them directly to the record view.</p>

Process Definition Menus

The following sections describe the various menu options in the Process

Definitions module with links to more information about each option in the User Interface documentation or, for process definition-specific functionality, within this page.

Module Tab Menus

The Process Definitions module tab is located on the navigation bar at the top of the Sugar screen when the administrator is engaging with the Process Definitions module. Click the tab to access the Process Definitions list view. You may also click the triangle in the Process Definitions tab to display the Actions, Recently Viewed, and Favorites menus. The Actions menu allows you to perform important actions within the module. The Recently Viewed menu displays the list of process definitions you last viewed in the module. The Favorites menu displays the list of process definitions you most recently marked as favorites in the module.

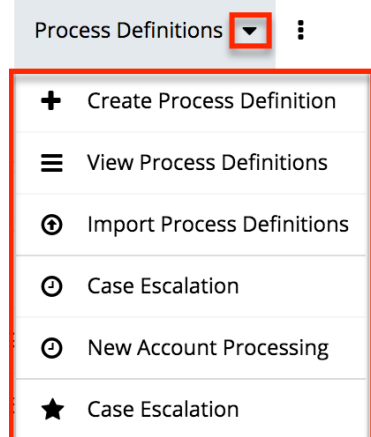

The Actions menu allows you to perform the following operations:

Menu Item	Description
Create Process Definition	Opens the record view layout to create a new process definition
View Process Definitions	Opens the list view layout to search and display process definitions
Import Process Definitions	Opens the import wizard to enable import of .bpm files

If you do not see the Process Definitions module tab in Sugar, please check the following:

- SugarBPM is not available for Sugar Professional. If you are using Professional but would like to leverage SugarBPM for SugarBPM functionality, please [contact your Sugar Account Manager](#) for information

on upgrading your instance.

- To access the Process Definitions module or the Process Definitions module tab, you must be a [System Administrator user](#) or a regular user with a role that provides [developer access](#) to one or more modules.
- The Process Definitions module may be marked as hidden in your user preferences which will prevent the module tab from being displayed. Navigate to your user profile (upper right of Sugar), click the Advanced tab, and check the Layout Options section. If you see the Process Definitions module in the Hide Modules list, simply move it to the Display Modules list and save. For more information on hiding and displaying modules, please refer to the Layout Options section of the Getting Started documentation.
- The administrator may have disabled the Process Definitions module for your entire Sugar instance. Reach out to your Sugar administrator to have the Process Definitions module displayed. For more information on displaying and hiding modules throughout Sugar, please refer to the Developer Tools documentation in the Administration guide.

List View Record Actions Menu

The Record Actions menu to the far right of each record's row allows you to perform actions on the individual process definition record directly from the list view.

	Name	Target Module	Status	
☆	New Account Processing	Accounts	Enabled	 ▼
★	Case Escalation	Cases		Design
☆	Idle Account Send Message	Accounts		Edit
☆	PBRulesDef	Revenue Line Items		Export
				Delete
				Disable

The list view's Record Actions menu allows you to perform the following operations:

Menu Item	Description
Preview (Eye icon)	Preview the design of this process definition in the intelligence pane
Design	Navigate directly to the process definition's Visual Designer, where you

	can create and edit the process flow
Edit	Edit this process definition
Export	Download a copy of this process definition to your computer as a .bpm file
Delete	Delete this process definition
Enable/Disable	Enable or disable this process definition

Record View Actions Menu

The process definition's [record view](#) displays the fields relevant to the Process Definitions module. To access a process definition's record view, simply click a hyperlinked process definition name from the Process Definitions list view. The record view's Actions menu appears on the top right of the page and allows you to perform various operations on the current record.

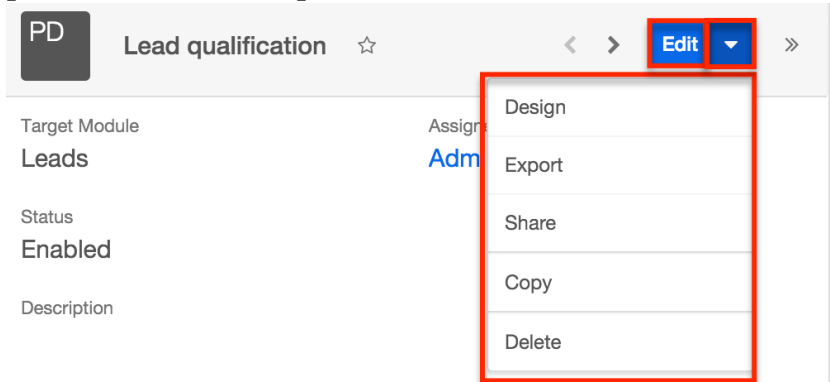

The Actions menu allows you to perform the following operations:

Menu Item	Description
Edit	Edit this process definition
Design	Navigate directly to the process definition's Visual Designer, where you can create and edit the process flow
Export	Download a copy of this process definition to your computer as a .bpm file
Share	Share a link to this process definition in Sugar via email
Copy	Duplicate this record to make a new

	process definition
Delete	Delete this process definition

Process Definitions List View Dashlets

There are two specialized dashlets available exclusively on the intelligence pane for the Process Definitions module's list view. The following sections describe these dashlets, which offer insight into running processes in your instance.

Note: For more information on creating dashboards and adding dashlets to the intelligence pane, please refer to the [Dashboards and Dashlets](#) documentation.

Pending Activities by Process

The Pending Activities by Process dashlet displays a summary of the total number of activities that are awaiting a response from a process user. All open process activities are reflected in the dashlet as a whole number and are also grouped by user in the circular graph.

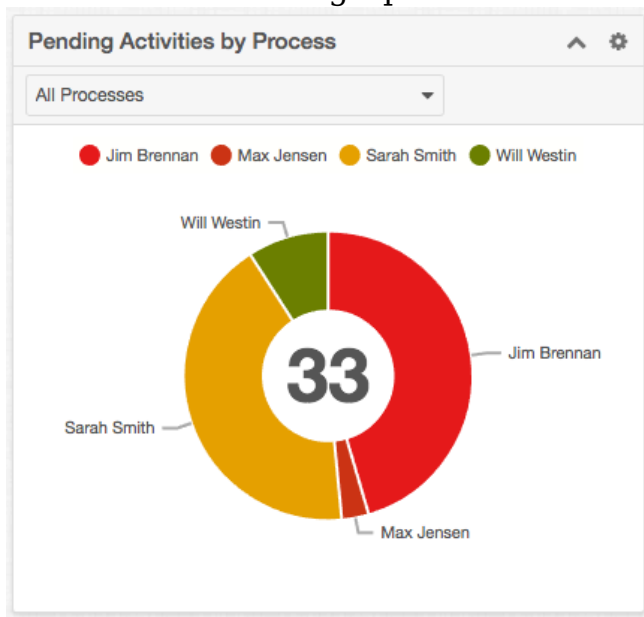

You can refine the dashlet's view by selecting a process definition from the dashlet's filter. This will restrict results to only the processes related to that process definition.

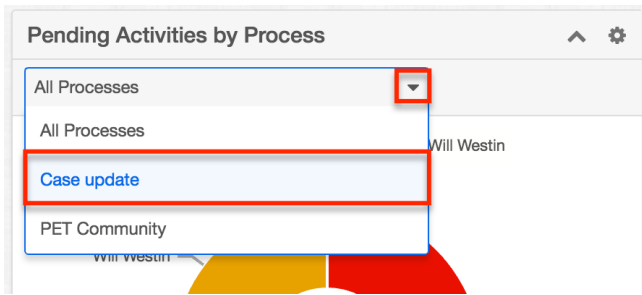

Process Summary Dashlet

The Process Summary dashlet can also be added to the Process Definition's list view intelligence pane. It displays an overview of all processes that have triggered in your instance.

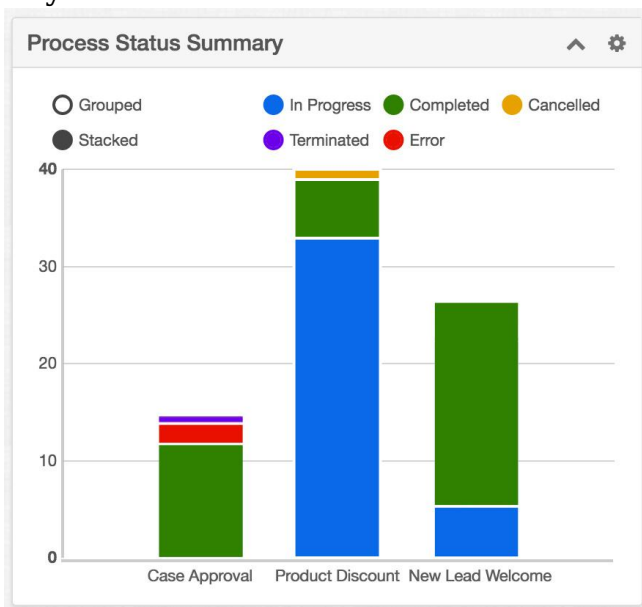

You can customize the dashlet view using the options above the chart. Toggle the display between "Stacked" and "Grouped" to view the results in different formats. To exclude a status from the display, click on the solid circle next to that status' name in the key above the chart.

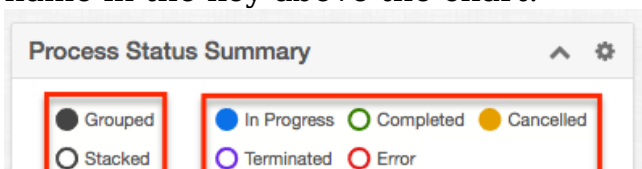

Creating Process Definitions

Note: All process definitions are disabled by default so that they will not trigger during the design phase. Please refer to the [Enabling Process Definitions](#) section of this page for steps to enable a completed process definition.

Process Definitions can be created from any of the following places in Sugar:

- Process Definitions dashlet:

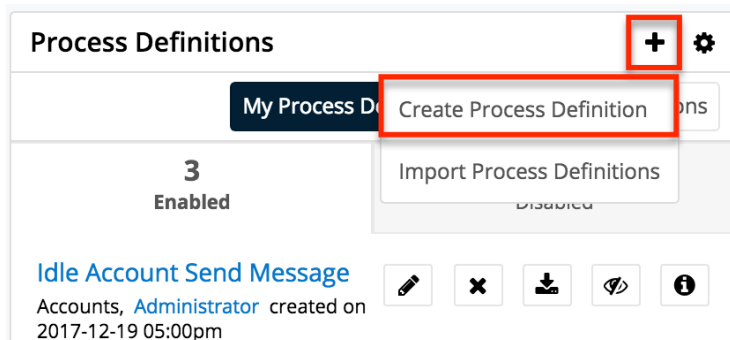

- Process Definitions module tab menu:

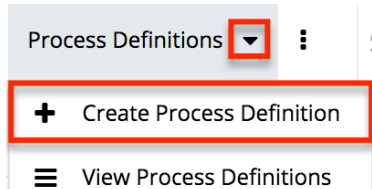

- Process Definitions list view:

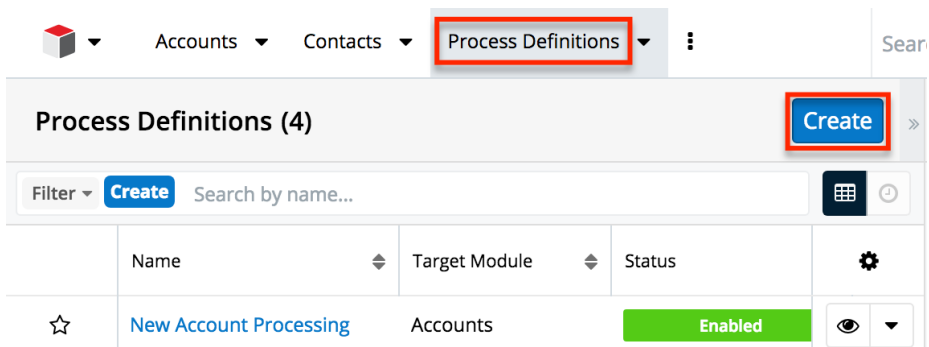

Upon clicking "Create Process Definition" (or the Create button from list view), you will be directed to the process definition's record view. The record view is where you store information that will make it easy to find and understand the process definition in the future. For more information about the available fields in the Process Definitions module, please refer to the [Process Definitions Fields](#) section of this documentation.

PD Name
Get Approval on Opportunity Cancel Save & Design

Target Module: Opportunities Assigned to: Administrator

Status: Disabled

Tags:

Description:
A Process Definition that defines the approval process for opportunities.

After completing this form, you will be directed to the [Visual Designer](#) canvas where the process definition's elements can be composed.

Designing Process Definitions

Creating a process definition for your business process is easy using SugarBPM's visual designer, where you can graphically assemble a series of flow elements using an intuitive drag-and-drop interface. All process definitions are set to "Disabled" by default in order to prevent triggering of processes before the design is complete. This means that you must change the status to "Enabled" before it will work. Please see [Enabling Process Definitions](#) for more information.

Using the Visual Designer

Before designing a process definition, take a moment to understand how to interact with process definition elements on the design canvas. In the visual designer, process definitions are auto-saved every 30 seconds by default, and the Undo button can revert changes as far as 25 levels back per session. You can disable or adjust the auto-save increment via Admin > [System Settings](#).

Note: The visual designer interface may not be compatible with some touchscreen mobile devices. Please build process definitions from a desktop or laptop computer to prevent any potential complications.

Editing Tools

If you edit the design of an enabled process definition, any running process will immediately adapt to the new flow pattern. Therefore, it is best practice to disable

a process definition before making changes to its design. Disabling the process definition will prevent running processes from adapting to the new flow prematurely. Changing the process definition's status to "Disabled" will not cause any interruptions to already running processes. Upon re-enabling the process definition, any processes still running will adapt to the new flow.

Three icons on the right side of the design toolbar represent editing tools for your process definition design.

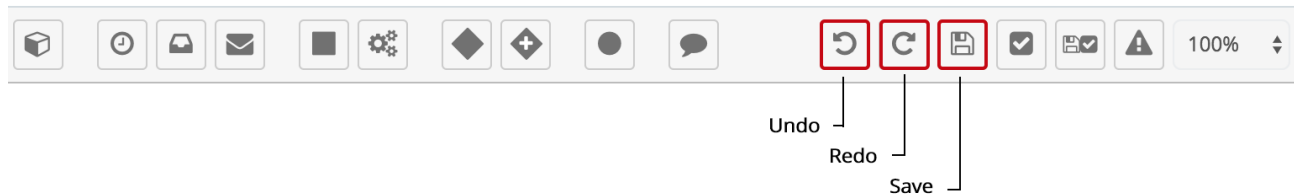

- **Undo** : Click the Undo button to revert the last change made in the Process Definition (up to 25 changes). When an undo action restores a design element on the page, it should also restore the element's configuration, but you should always confirm the configuration via the element's settings.
- **Redo** : Click the Redo button to reverse an undo action. When a redo action restores a design element on the page, it should also restore the element's configuration, but you should always confirm the configuration via the element's settings.
- **Save** : This control allows you to save changes made to the Process Definition design. The Save button is enabled only when there are unsaved changes. Keep in mind that the Visual Designer auto-saves your work every 30 seconds by default and the auto-save increment can be configured or disabled via Admin > [System Settings](#).

Always review the settings for any canvas element re-instated by the Undo or Redo buttons to confirm they are configured as expected.

Process Validation

When using the SugarBPM visual designer for creating process definitions, a validation job periodically runs to inspect the layout and configuration of the process definition's elements. The validation job may run automatically at regular intervals configured in Admin > [System Settings](#), and the administrator may also manually trigger the validate action at any time from the designer toolbar.

Three icons on the right side of the design toolbar represent the validation tools for your process definition design.

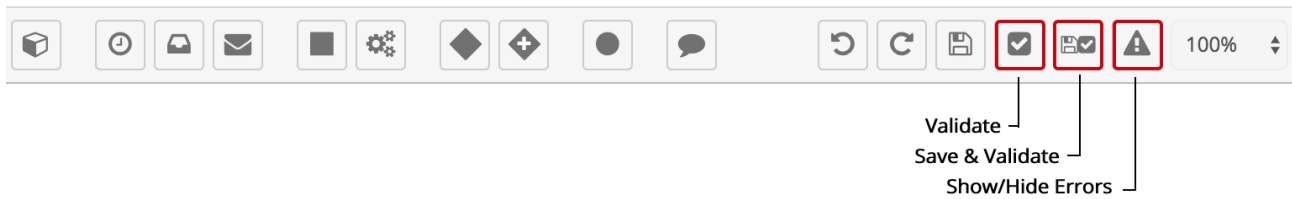

- **Validate** : The Validate button triggers an action that inspects each element in the design and verifies that evaluations and settings are valid. Any errors or warnings are displayed as badges on the affected elements and in the Error Console in the lower part of the screen.
- **Save and Validate** : Click the Save and Validate button to save your work and simultaneously validate the process design.
- **Show/Hide Errors** : Click this button to view or minimize the Error Console. The console displays warnings and errors that were found in the last validation action and may not reflect changes you have made since the last validation ran. For the most accurate information, click on Validate or Save and Validate immediately after repairing any errors.

Any configuration or sequence flow errors will be displayed in the Process Validation pane at the bottom of the design canvas. Expanding the validation pane will not force a new validation, but clicking "Validate" or "Save and Validate" will automatically expand the validation pane if it has been minimized or not yet opened.

Some errors will occur and then resolve themselves naturally as the Process Definition is pieced together. For example, all elements will be considered in an error state until the appropriate connectors have been inserted in between elements. For more information on the errors and warnings returned by the process validator, refer to the article [Troubleshooting Validation Errors and Warnings for Process Definitions](#).

Comments

The Comment element allows admins to mark up the designer canvas with helpful annotations connected to Action and Activity elements. While all elements can be descriptively labeled, further explanation may be needed to explain more complex Process Definitions.



To insert a comment onto the Designer Canvas, simply drag and drop the comment

icon onto the canvas and then double-click on the text "Text Annotation" to type a comment. Hit Enter to preserve the comment.

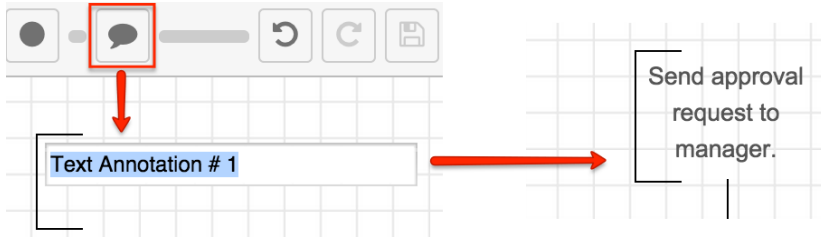

Sequence Flow

When you assemble a process definition, you are defining the overall sequence flow. The flow dictates the processing order of the events, actions, and activities in a process and is visually represented by lines called sequence connectors. Each sequence connector originates from a single source element (e.g. action, event, etc.) to a single target element.

Adding Sequence Connectors

All elements of a process flow must be connected by at least one directional line. Failure to connect flow elements correctly will result in an error in the [Process Validation panel](#).

1. To connect two elements on the Designer canvas, hover over the outer edge of the Start event icon until the mouse tip changes into a crosshair:

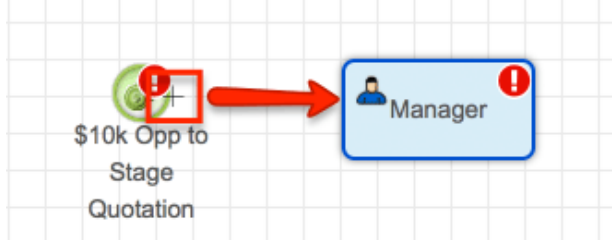

2. Click the mouse button and drag the black square at the end of the connector onto the subsequent design element:

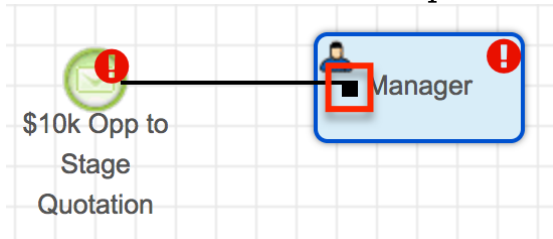

3. Release the mouse button and the square at the end of the connector line will transition into an arrow pointing toward the subsequent element and indicating the direction of flow from one element to another.

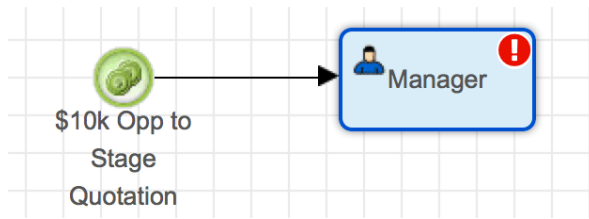

4. Optionally, adjust the position of the process elements as described in the [Moving and Deleting Design Elements](#) section to achieve an organized appearance.

Note: When dragging a connector to a subsequent element, you may choose to release the mouse button at the top, bottom, left, or right edge of the element in order to aesthetically organize the process and avoid running into other connector lines, which may possibly affect the flow of the process. For more information on interacting with objects on the canvas, please refer to the [Moving and Deleting Design Elements](#) section of this documentation.

Removing Sequence Connectors

To remove unwanted or misplaced sequence connectors from the design canvas, simply click on the line and press Delete on your keyboard as explained here:

1. Click on the segment of the line that you wish to remove. The connector will transition to a selected state, and the beginning and end points of the connector line will be represented by red dots. Please confirm that the line connecting these red dots is the line that you intend to delete.

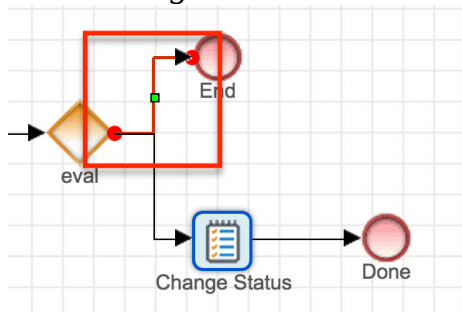

2. Press the Delete key on your keyboard. The selected line will disappear.

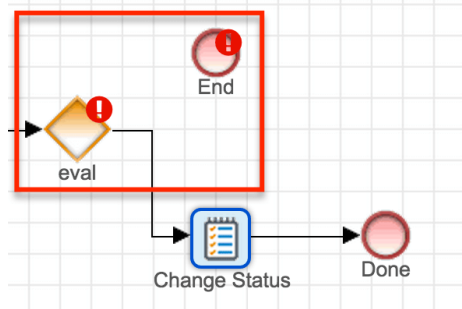

If you accidentally delete a sequence connector, simply press the [Undo button](#) on

the toolbar. Always review the settings for any canvas element reinstated by the Undo or Redo buttons to confirm they are configured as expected. For more information on interacting with objects on the canvas, please refer to the [Moving and Deleting Design Elements](#) section of this documentation.

Moving and Deleting Design Elements

To reposition or remove an entire branch or group of elements from a process definition design, you can easily mass select them on the canvas. The following table summarizes the mass actions available via the design canvas.

Task	Procedure
Select a single element	Point to the element on the design canvas until the mouse tip becomes a four-headed arrow then click the shape.
Select multiple elements within an area	Click on the design canvas above and to the left of the elements that you want to select and then drag to create a selection box around the shapes. Any elements partially within the selection area will be included as part of the selection.
Move an element or group of elements using your mouse	<ol style="list-style-type: none">1. Select the element(s) that you want to move.2. Position the mouse pointer over one of the elements. A four-headed arrow appears.3. Click and drag the elements to their new positions.4. All of the selected elements will move the same distance and direction from their original positions.
Nudge an element or group of elements using the arrow keys	<ol style="list-style-type: none">1. Select the element(s) that you want to move.2. Press an arrow key in the direction you want the group to move. The elements will nudge one pixel for each tap of an arrow key. Press and hold the arrow key to move the elements quickly.

	<p>Note: If pressing an arrow key scrolls or zooms the entire canvas instead of moving the selected elements, please make sure that the SCROLL LOCK key is disabled on your keyboard.</p>
Delete an element or group of elements within an area	<ol style="list-style-type: none"> 1. Select the element(s) that you want to delete. 2. Press the delete key to remove the selected items from the design canvas. <p>Note: Sequence connectors associated with deleted elements will also be deleted.</p>
Delete a sequence connector	Please refer to Removing Sequence Connectors for more information on how to remove unwanted or misplaced sequence connectors from the design canvas.
Deselect all elements	Click a blank area on the design canvas.

Evaluation Criteria Box

Certain elements in the process definition design can be configured in a criteria box. For these evaluations, you can interact with the operators and variables that comprise the criteria in the following ways:

Criteria pills are movable via drag and drop:

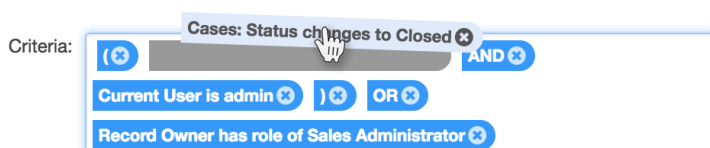

Criteria can be inserted by placing a cursor at the point of insertion and then clicking on the operator or variable to insert:

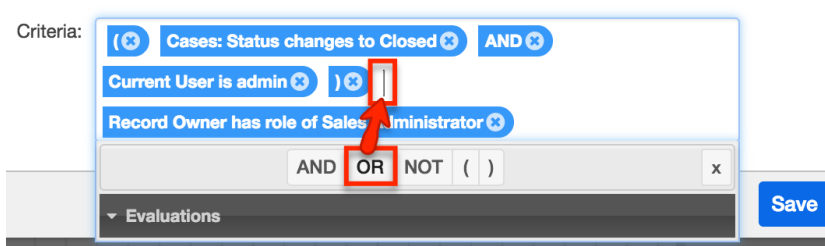

Note: Never use single quotes (' ') or double quotes (" ") inside the criteria builder; the SugarBPM engine automatically recognizes input types when processing the condition.

For more information on defining criteria, please refer to the [Setting Conditions](#) section of this page.

Process Definition Settings

Every process definition has a well-concealed option to configure important overall settings. To access this option, simply right-click on any empty space on the process definition's design canvas and select the "Process Definition" menu item:

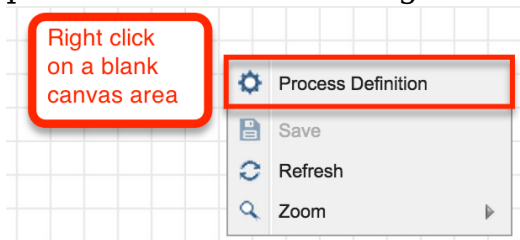

The Process Definition settings window will open where you can edit the name and description without exiting the designer. In addition, the settings window contains two tools for enhanced security over records that engage in processes triggered by the current process definition. The following sections describe how to configure [Terminate Process](#) conditions and how to prevent users from making changes to records during the process duration via [Locked Fields](#).

Terminate Process

All process definitions should include a condition for termination. Informally known as the process definition's "emergency brake," the Terminate Process settings can tell Sugar when NOT to start a process or under what conditions a process should abruptly end. If a process' target record meets the Terminate Process conditions, the process instance will instantly force stop and display a status of "Terminated" in the Process Management list. This setting is important to prevent conflicts between multiple running processes or conflicts between SugarBPM and other automated parts of your Sugar instance (e.g. Workflows, Sugar Logic, or third party customizations).

Follow these steps to define Terminate Process conditions for a process definition:

1. Navigate to the Visual Designer canvas for the relevant process definition.
2. Find a blank spot on the design canvas and right-click to access the Process Definition's general settings.

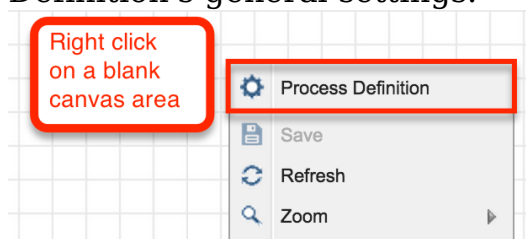

3. Click on "Process Definition". The Process Definition settings will appear. Here you can edit the record-level settings and set Terminate Process criteria for this process definition.

4. Click inside the Terminate Process field to reveal the criteria builder.

5. Refer to the [Module Field Evaluation](#) section of this page to build a conditional statement that, when met, will force-stop a running process that was triggered by this process definition.

6. Click "Save" to preserve this setting and return to the design canvas. Be sure to save the overall process definition before navigating away from the canvas.

Locked Fields

The Locked Fields feature of SugarBPM lets administrators, developers, and process administrators prevent users from changing select field data on records that are involved in active processes. Any number of fields (from none to all) can be locked on the record. When a record becomes involved in a process that has locked fields, that record will respect those field locks until the record is no longer participating in the process.

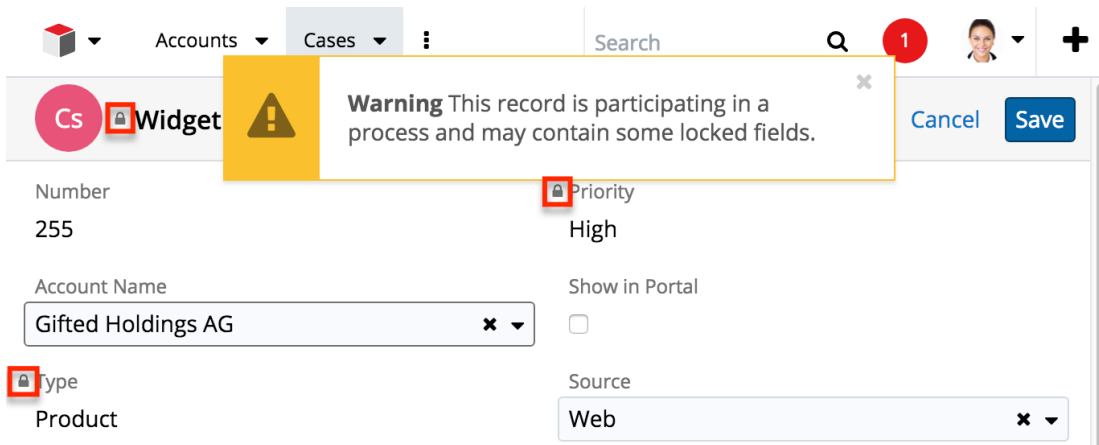

Note: Locked Fields configured in the Process Definition settings **do not apply to the process user** when he or she is executing the process. To prevent the process user from editing fields during the approve/reject or route stage, you must configure the fields as read-only on the Activity's [Read-Only Fields tab](#).

Follow these steps to set Locked Fields for records participating in the current process definition:

1. Navigate to the Visual Designer canvas for the relevant process definition.
2. Find a blank spot on the design canvas and right-click to access the Process Definition's general settings.
3. Click on "Process Definition".

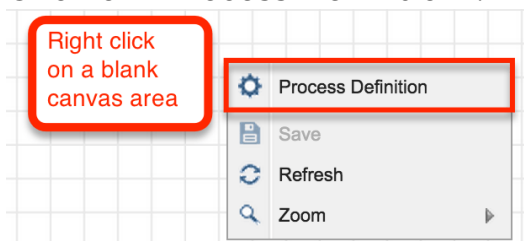

4. The Process Definition settings will appear. Here you can edit the record-level settings and set Locked Fields for this process definition. In the Locked Fields section, place a checkmark next to the field or fields for which you would like to prohibit editing:

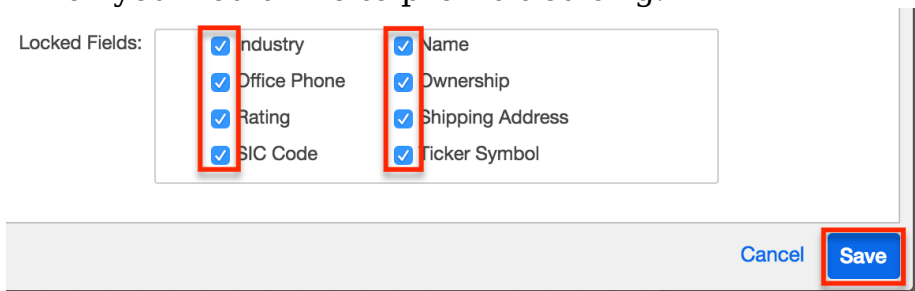

5. Click "Save" to preserve this setting and return to the design canvas. Be sure to save the overall process definition before navigating away from the canvas.

Note: Records that are processed through the job queue, imported, mass updated, or merged will undergo locked-field validation.

Adding a Start Event

A Start event indicates where a process will begin. It defines the action that will trigger a new process to run. The target module chosen in the process definition's record view is the module that is used for the Start event in the process definition design. When a record in the target module meets the criteria set in the Start event, then a new process will commence based on this process definition. In other words, the Start event will receive a message from the target module that it is time to begin a new process.

Start Event

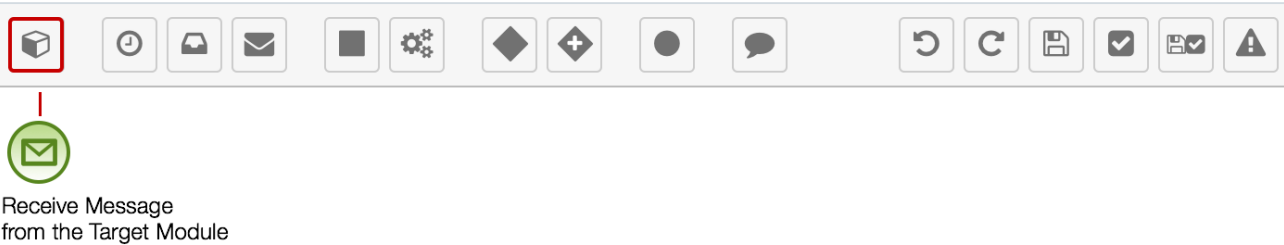

Follow these steps to add a Start event to the process definition:

1. Drag the Start event icon onto the Designer canvas.

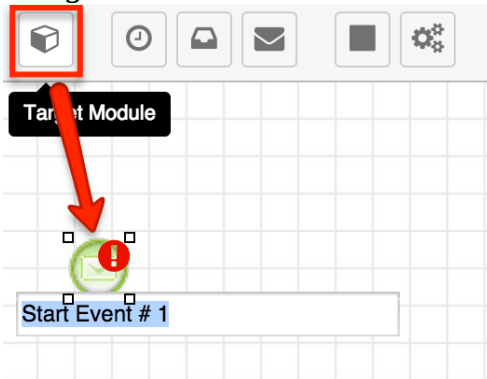

2. Double-click the Start event icon's label to rename it.

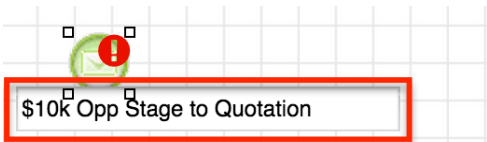

Note: The Start event will have an error icon and a warning icon if the process validator runs before the Start event has been configured and connected to the next element. This is normal. For more information about resolving validation errors, refer to the [Process Validation](#) section of this page.

3. To configure the Start event, right-click on the Start event icon and choose "Settings".

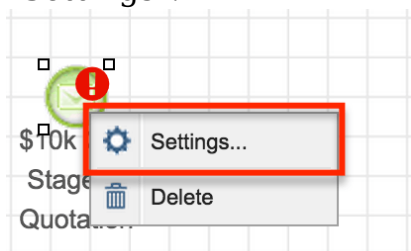

4. Select an "Applies to" preference. Click on the down arrow to select how the process definition will be triggered to start. There are three options:

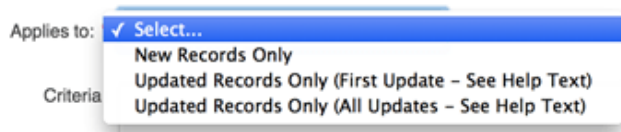

- **New Records Only** : A new process will begin if a record is created and the specified conditions are met on the first save.
 - **Updated Records Only (First Update)** : A new process will begin the first time the specified conditions are met on an existing record, even if the record has been updated several times before it qualifies. Once a record meets the conditions to trigger a First Update process, it cannot trigger that process definition again.
 - **Updated Records Only (All Updates)** : A new process will begin every time an existing record is saved and the specified conditions are met, as long as the process is not already running against the record. A given process definition can only run one process instance against a particular record at a time. However, it is important to note that two or more different process definitions may simultaneously run against the same record.
5. Click inside the Criteria field to expose the criteria builder and set the conditions for the Start event. Please refer to the [Creating Conditions for Events and Actions](#) section of this page to configure the conditions for the Start event.

Note: Comparison operators in [Start event evaluations](#) may not always work as expected for existing records that were last edited before the process definition was enabled. To ensure that existing records are evaluated properly for comparators such as "field changes from/to", perform an arbitrary mass update on the target module's records immediately after enabling the process definition so that Sugar can capture the "from" field values.

Adding Multiple Start Events

A single process definition may have multiple Start events as long as those Start

events contain mutually exclusive criteria. In other words, only one Start event can evaluate to "true" for any given record. If it is possible for two or more Start events to evaluate as "true" against one Sugar record, the criteria for these Start events will be met simultaneously. SugarBPM does not support this type of configuration.

The following table demonstrates the proper and improper use of multiple Start events:

		Applies to	Criteria	Explanation
☐ Good design	Start Event #1	Accounts; New Records Only	Type {is} Customer	A Sugar record cannot be simultaneously "new" and "updated" (i.e., existing). It is therefore impossible for these two Start events to evaluate as "true" at the same time, making them mutually exclusive.
	Start Event #2	Accounts; Updated Records Only (First Update)	Type {is} Customer	
☐ Bad design	Start Event #1	Accounts; New Records Only	Type {is} Customer	This combination of Start event criteria is not mutually exclusive. A new account in Sugar may be classified as both "Manufacturing" and "Customer", which would make both events evaluate as "true". Instead, use one Start event with an OR operator

	Start Event #2	Accounts; New records Only	Industry {contains} Manufacturing	between the two sets of criteria.
--	----------------	----------------------------------	---	---

The "Good design" example above applies a process definition to both new and updated records by using one Start event triggered by "First Update" and a second Start event triggered by "New Records Only". When using multiple Start events, join each of them to the next element in the process definition with separate connectors. Multiple Start events in a process definition should always merge into a single path.

Adding Intermediate Events

As the name suggests, intermediate events occur after a process starts but before the process is complete. Intermediate events that are placed within the overall process flow represent things that happen during the normal operation of the process such as sending messages, receiving messages, or mandatory waiting periods.

Note: Intermediate events require the SugarBPM Scheduled Job scheduler to execute. If schedulers are not running, the flow of the process will be interrupted. For more information, please refer to the [SugarBPM](#) documentation.

Intermediate events are represented by the second group of icons on the design toolbar. There are three icons that each enable a configurable event.

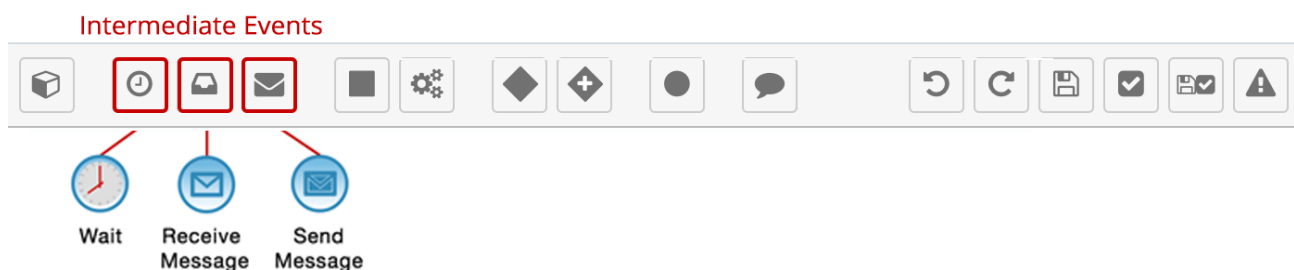

The types of intermediate events are:

- [Wait Events](#)
- [Receive Message Events](#)
- [Send Message Events](#)

Wait Events

This element will stop the execution of a process by the time interval set in the

configuration. Wait events support specified times as well as a calculated delta between two times or events.

Note: Schedulers, specifically the SugarBPM Scheduled Job, must be running to execute Wait events. If schedulers are not running or if the event is not properly configured, the flow will be halted indefinitely, thereby stopping the flow of the process. For more information, please refer to the [SugarBPM](#) documentation.

A Wait event's clock begins when the Wait event is triggered. For example, consider a process definition that contains three five-minute Wait events. Each one will pause and evaluate a running process at 5-minute intervals for an aggregate 15 minutes of wait time from the beginning until the end of the process definition. While the Wait events enforce an evaluation at 5, 10, and 15 minutes into the process, the settings for each element need only account for the 5-minute span between timed events, and not its relative distance from the start of the process. Therefore, the Duration setting for each Wait event in the example should be set to 5 minutes.

To add a Wait event to the flow, drag and drop the clock icon onto the canvas:

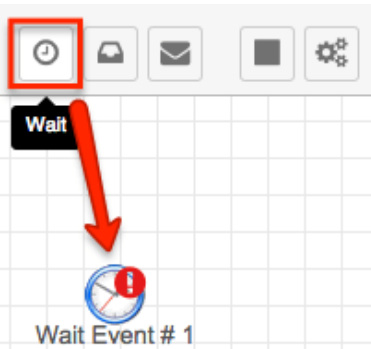

To configure this event, right-click on the icon and choose "Settings". A new window will display:

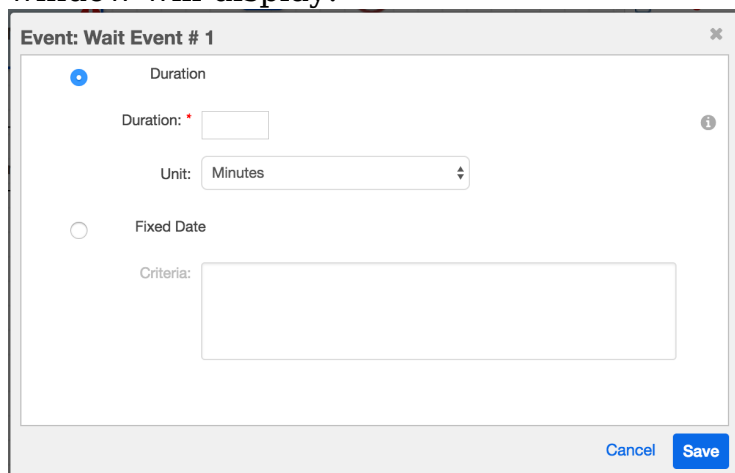

The configuration window has two main options: Duration and Fixed Date. Choose one of these options to enable its configuration fields.

-
- **Duration** (radio button) : Choose this option to define the duration of the Wait event in minutes, days, or hours.

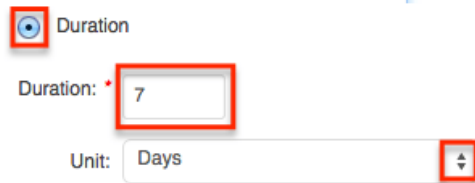

- **Duration** (text field) : Required field when "Duration" is selected above. Enter an integer to use in conjunction with the Unit field.
- **Unit** (dropdown) : The duration defined in days, hours or minutes.
- **Fixed Date** (radio button) : Choose this option if the Wait event will be based on one or more of the record's datetime fields, a specific date, or a calculated formula. Formulas may be constructed using a combination of operators, Sugar variables, and constants.

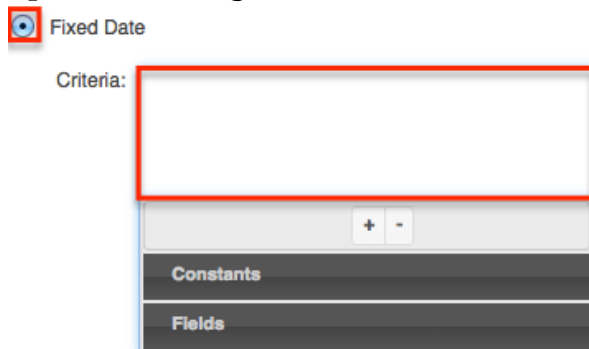

- **Criteria** : Click inside this field to reveal the criteria builder. Please refer to the [Creating Conditions for Events and Actions](#) section of this page for instructions on using the criteria builder.

Receive Message Events

This event will stop the flow of a process definition until the established criteria in the configuration are accomplished. In essence, it is a Wait event that pauses until a condition is met instead of for a specified duration. Most notably, Receive Message events can detect when a field's value changes or when it changes to or from a particular value.

Note: Schedulers, specifically the SugarBPM Scheduled Job, must be running to execute Receive Message events. If schedulers are not running or if the event is not properly configured, then the event will stop the flow of the process. For more information, please refer to the [SugarBPM](#) documentation.

To add a Receive Message event to the flow, drag and drop the Receive Message icon onto the canvas:

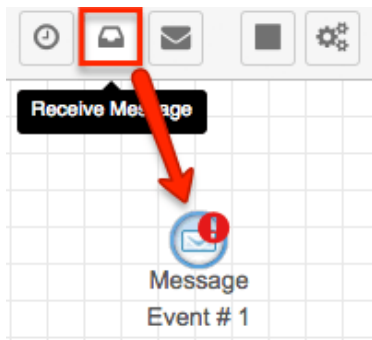

To configure this event, right-click on the icon and choose "Settings". A criteria builder window will display:

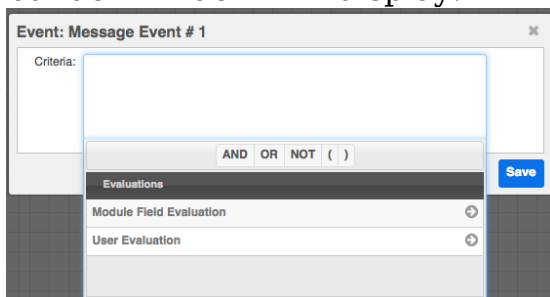

Click inside the Criteria field to reveal the criteria builder. Please refer to the [Creating Conditions for Events and Actions](#) section of this page for further instructions.

Send Message Events

This event is the only one that can send email messages. These messages must be created in the [Process Email Templates](#) module. Your email template can contain field variables to reference actual data from your target record or its related records.

Note: Schedulers, specifically the SugarBPM Scheduled Job, must be running to execute Send Message events. If schedulers are not running or if the event is not properly configured, the flow will ignore the event and continue running without sending any mail. For more information, please refer to the [SugarBPM](#) documentation.

Note: If your email template has been configured with a variable to show the old value of a changed field, it is important to strategically position the Send Message event within your process definition's design. For more information, refer to the [Process Email Templates](#) documentation.

To add a Send Message event to the flow, drag and drop the envelope icon onto

the canvas:

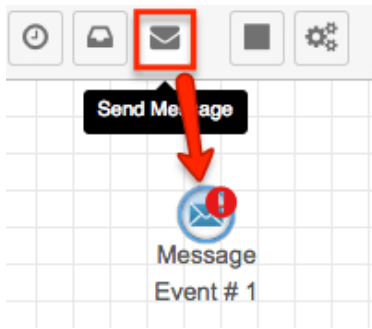

Right-click on the canvas icon and select "Settings" to open its configuration window, which contains the following options:

- **Module** : (read-only) This is the module that was set as the target module for the process definition and which also must be the target module for the email template.
- **Email Template** : (required) Choose an email template from the dropdown list. This list will only display templates that use the target module shown in the previous field.
- **From** : (required) Choose who should be shown as the sender of this email. Options include users associated with the target record (e.g. Record Owner), System Email, any Sugar user, and any outgoing email account configured in Sugar. If you select a user, the name of the sender will be the user's first and last name, and the email address of the sender and reply-to email address will be their primary email address. For details on how these fields are set for outgoing email accounts, see the [Emails](#) documentation.
- **To (required), Cc, Bcc** : Specify the message's recipients. For more information, refer to the [Working With Recipient Fields](#) section.

A screenshot of the 'Event: Message Event # 1' configuration window. The window has a title bar with a close button (X). The main content area contains several fields:

- Module**: A dropdown menu with 'Opportunities' selected.
- Email Template**: A dropdown menu with 'Opportunity Approved!' selected.
- From**: A dropdown menu with 'Supervisor' selected.
- To**: A text input field containing 'User who is assigned to the Opportunities' with a refresh icon.
- Cc**: A text input field containing 'User who created the Opportunities' with a refresh icon.

At the bottom right of the window, there are 'Cancel' and 'Save' buttons.

Note: Marketing and campaign emails should never be sent using SugarBPM. This is because SugarBPM does not respect the subject's request to opt out, which

raises a liability concern.

Working With Recipient Fields

Recipient fields for Send Message events have options that are unique when compared with the recipient fields in Sugar's Emails module. Send Message events can be configured to send messages to individual recipients or users, members of user teams or roles, their user relationships such as a supervisor, users who created, modified, or are assigned to records, and other recipients from the process's target record or records related to the target record.

Email addresses can be added to the recipient fields via a combination of [free entry](#) in the recipient box and using the [User](#), [Recipient](#), [Teams](#), and [Role](#) menus. These methods are described in the following sections.

The image shows a user interface for adding recipients. At the top, there is a 'To: *' text input field with a red box around it. Below this is a 'Cc:' dropdown menu. The dropdown menu is open, showing four options: 'User', 'Recipient', 'Teams', and 'Role'. Each option has a right-pointing arrow button next to it, which is also highlighted with a red box. A 'cancel' button is visible at the bottom right of the dropdown menu.

Adding Recipients via Free Entry

When you click inside the text area and start typing, Sugar will display a list of suggestions that auto-updates as you type. If the text you enter is found in an email address or name field for a record that has an email address in Sugar, then the corresponding record will be suggested as a potential match. You may click on a matching recipient to add their email address to the distribution list or continue typing a complete email address (e.g., mail@example.com) directly into the To, CC, or BCC field. When entering email addresses directly, press the Enter key after each address.

To: *

Cc:

- Ceola Connors**
sugar.qa@example.net
- Tennie Constable**
vegan80@example.net
- Constrata Trust LLC**
hr.the@example.edu

Adding Recipients via User Menu

To send a message to a user or the manager of a user associated with the target record, expand the User recipient panel.

To: *

Cc:

Field	Value
Status	is equal to In Progress
Related To	Select...
Field	Value
	is

The User panel contains five rows but only the topmost Module field and bottom-most User row (highlighted in red above) are required. The available options are:

- **Module** (required) : Select the first-level module relationship to the user recipient.
 - If the user (or user's manager) is related to the target record, then

select the target module. For example, the user who created or is assigned to the target record.

- If the user is related to a one-away record (e.g. a user who is related to a record that is related to the target record), then select the module that contains the user field.
- If the user is related to a two-away record (e.g. a user who is related to a record that is related to a record that is related to the target record), then select the intermediate module here, not the target module nor the module that contains the user field.
- **Field/Value** : Optionally, apply a filter to the first-level module. For example, if the first-level module is Opportunities, you can restrict the criteria to apply to only in-progress opportunities by setting "Status > is equal to > In Progress".
- **Related To** : Optionally, select a second-level module relationship. For example, set the second-level module to Contacts if you want to send an email to the users related to contacts that are related to the records in the first-level module.
- **Field/Value** : Optionally, apply a filter to the second-level module.
- **User** (required; not labeled) : In the final row, select whether to send the message to a user or to the user's manager, and what their relationship to the bottom-most selected module is.

Note: Another way to add users as recipients is to message all users on a Sugar team. Refer to the [Teams](#) recipient option for more information.

Adding Recipients via Recipient Menu

To send a message to an email address stored in the Sugar database within the target module or a related module's email address field, expand the Recipient panel.

The screenshot shows the 'Recipient' menu with the following configuration:

- Module:** <Opportunities>
- Field:** Select... **Value:** is
- Related To:** Contacts [*:M] (Contacts: contacts)
- Field:** Title **Value:** contains **manager**
- Email Address Field:** Email Address

Buttons: Close, Add

The Recipient panel contains five rows but only the topmost Module field and bottom-most Email Address Field rows (highlighted in red above) are required. The available options are:

- **Module** (required) : Select the first-level module relationship to the recipient.
 - If the recipient's email address is on the target record, then select the target module.
 - If the recipient's email address is on a one-away record (e.g. in a field on a record that is related to the target record), then select the module that contains the email address field.
 - If the recipient's email address is on a two-away record (e.g. in a field on a record that is related to a record that is related to the target record), then select the intermediate module here; not the target module nor the module that contains the user field.
- **Field/Value** : Optionally, apply a filter to the first-level module. For example, if the first-level module is Opportunities, you can restrict the criteria to apply to only open and won opportunities by setting "Status > is not equal to > Closed Lost".
- **Related To** : Optionally, select a second-level module relationship. For example, set the second-level module to Contacts if you want to send an email to a recipient related to contacts that are related to the records in the first-level module field.
- **Field/Value** : Optionally, apply a filter to the second-level module.
- **Email Address Field** (required) : Finally, select the field that contains the recipient's email address.

Adding Recipients via Teams Menu

To send a message to the [explicit members of a Sugar team](#), expand the Teams panel. The Team dropdown menu shows all active teams in Sugar but does not list any private or inactive teams. To add all of the users on a team as recipients, select the team and then click "Add" to move the team's name to the distribution list. To add users from more than one team, simply select the next team and click "Add" again.

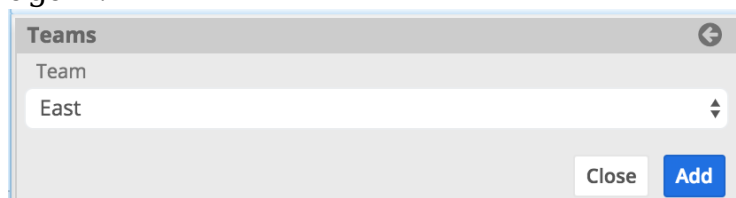

Adding Recipients via Role Menu

Click on the Role menu item to send a message to all of the users assigned to a specified Sugar role. To add users from more than one role, select the role, click "Add" and then select the next role and click "Add" again.

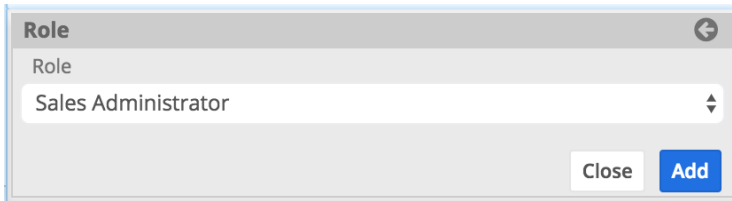

Adding Form Activities

The only unit of work that requires user interaction (opposed to automation) is an Activity. It is a moment within a flow where a user must decide if a circumstance is approved or rejected, or review a record that has been routed to them. Activities are represented by the solid square icon on the design toolbar:

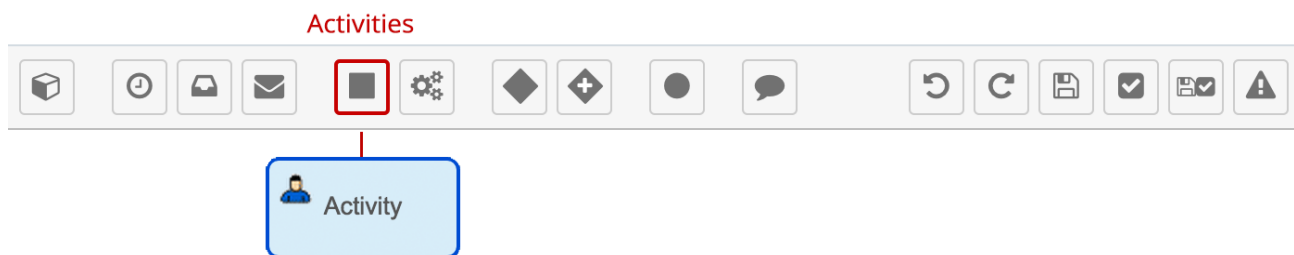

Activities pause a process until a user makes a decision to either approve or reject the record or indicates that they have reviewed a record that has been routed to them. When a process reaches this point in the flow, the appropriate user will see a line item in their Processes dashlet or Processes module list view. An Activity form element is configured in two steps. First, configure the [Forms](#) setting and then configure the [Users](#) setting.

To add a Form activity to the process definition's flow, drag and drop the Activity icon onto the canvas:

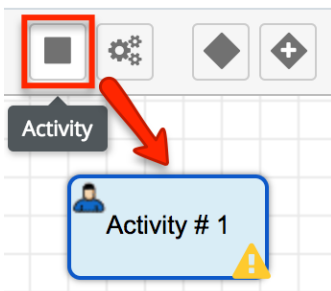

Forms Setting

The "Forms..." setting controls what type of form the process user will see when they are asked to execute this activity. The process user must be separately configured in the "[Users...](#)" setting. There are two types of Activity form:

- **Approve/Reject** : This type of form will present itself as an Approve button and a Reject button on the record view of the record that triggered the process. A Gateway element must be placed after the Approve/Reject activity in order to specify a flow for approval as well as a flow for rejection.
- **Route** : This type of form should be used to ensure that a record within a process has been viewed or edited by the user configured in the Activity's "[Users...](#)" setting. The form will present itself as a Route button on the record view of the record that triggered the process. The process user has the option to edit the record before clicking the Route button. The administrator may choose to ensure only relevant fields are edited by leveraging the [Read Only Fields](#) and [Required Fields](#) options for this activity.

Note: If an activity is not properly configured, it will default to an Approve/Reject form.

To configure the Forms setting for an activity, right-click on the icon and select "Forms...".

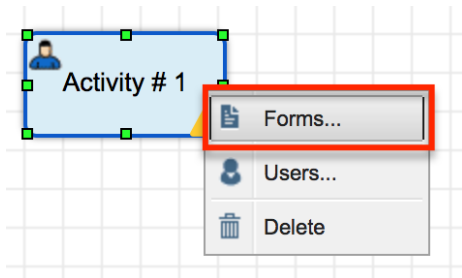

A configuration window will open. The configuration window has four tabbed sections.

- [General Tab](#)
- [Read-Only Fields Tab](#)
- [Required Fields Tab](#)
- [Expected Time Tab](#)

These are explained in detail in the following sections.

General Tab

View the General tab (displayed by default) to choose a form type for the activity.

Activity: Activity # 1

General | Readonly fields | Required fields | Expected Time

Form Buttons: Approve/Reject

Other Routing Options:

Change Assigned To User:

Team: Global

Select New Process User:

Team: Global

Cancel Save

- **Form Buttons** : Select the type of form to display.
 - **Route** : The user will be prompted to acknowledge that they have reviewed and optionally edited/commented on the record.
 - **Approve/Reject** (default) : The user will be prompted to approve or reject a circumstance. Approve/Reject Form activities should always be followed by a [Gateway element](#) with [Form Response Evaluation](#) criteria to define the next step of the process in the case of approval or rejection.

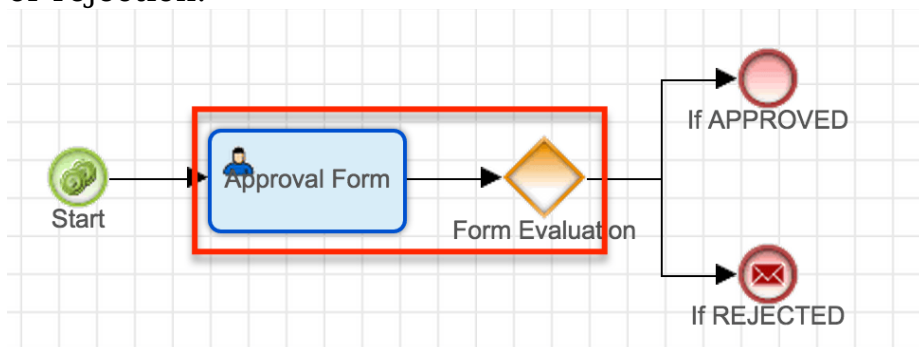

- **Other Routing Options**: During a Form activity's execution, the process user may be given the option to reassign the record associated with the process. It may be appropriate to create specialized teams for users who will be engaged in particular parts of a process. For more information about managing teams and users, see the [Team Management](#) and [User Management](#) sections of the Administration Guide.
 - **Change Assigned To User** : Enabling this option will add the "Change Assigned To User" option to the actions menu of the process execution screen, as seen here:

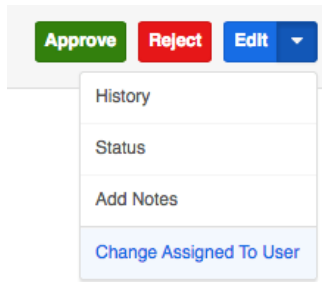

When the process activity is executed, the process user must select this option if they want to change the Sugar record's Assigned To user. The process user can only assign a user from the team configured by admin in the team field under "Other Routing Options".

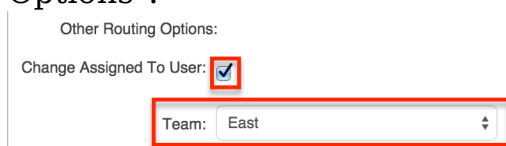

- **Select New Process User** : Enabling this option will add the "Select New Process User" option to the actions menu of the process execution screen, allowing the designated process user to delegate the Form activity to someone else. The process user can only select a new user from the team configured by admin in the Team field under "Other Routing Options".

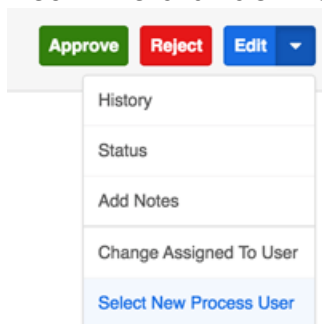

The current process user may select a new process user from the team configured by admin in the "Other Routing Options" Team field.

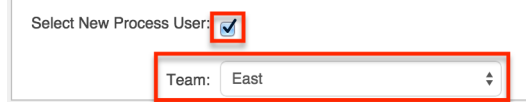

Read-Only Fields Tab

Here, the administrator can restrict the process user from editing some or all fields on the Sugar record for which the process applies. Place a checkmark next to the fields that should not be edited during the form processing step.

Note: Fields configured as [Locked Fields](#) in the Process Definition settings do not apply to the process user when he or she is executing the process. To prevent the process user from editing a field during the approve/reject or route stage, you must configure the fields as read-only in the activity's Read-Only Fields tab.

Required Fields Tab

In this tab, the administrator can require the process user to complete some or all fields on the Sugar record for which the process applies. Place a checkmark next to the fields that must be populated during the form processing step.

Expected Time Tab

Complete the fields in the Expected Time tab to set a timeout interval for the process user to execute this activity. When the time specified in the Duration field has expired, the activity will be considered overdue. If an Activity is overdue, the Due Date property will be shown in red on the process execution screen and the

process will appear in the "Overdue" tab of the My Processes dashlet.

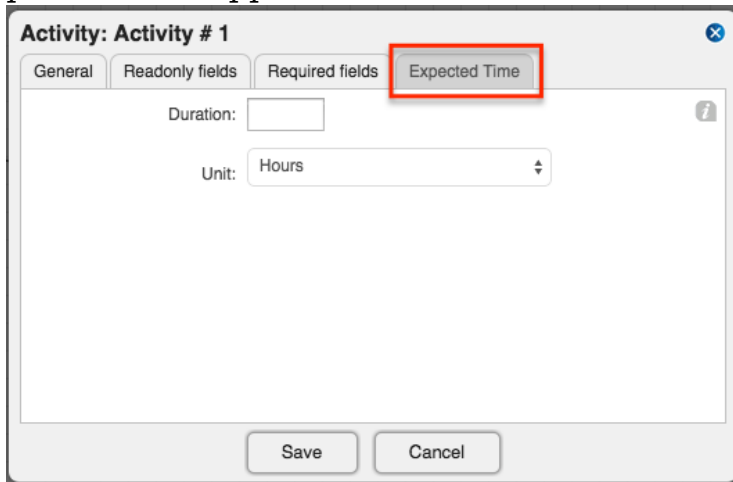

The screenshot shows a configuration window for 'Activity: Activity # 1'. It has four tabs: 'General', 'Readonly fields', 'Required fields', and 'Expected Time'. The 'Expected Time' tab is selected and highlighted with a red border. Below the tabs, there is a 'Duration' input field and a 'Unit' dropdown menu currently set to 'Hours'. At the bottom of the window are 'Save' and 'Cancel' buttons.

Users Setting

The "Users..." setting controls which user will be responsible for executing the process activity form. When a process reaches the activity in a flow, the process user will see a line item in their Processes dashlet or Processes module list view. The form type and other options must be separately configured in the "[Forms...](#)" setting.

Note: The Assignment Method chosen here refers only to the user that will execute the process, or "Process User". References to the Sugar record's assigned user are labeled "Assigned To User".

To configure the Users setting for an activity, right-click on the icon and select "Users...".

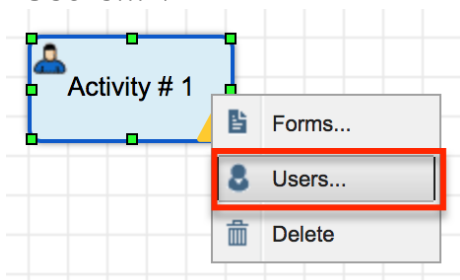

A configuration window will open. Choose one of the following process user assignment methods from the dropdown list:

- [Static Assignment](#)
- [Round Robin](#) (default)
- [Self Service](#)

These three options are explained in detail in the following sections.

Note: If this activity type is not properly configured, it will default to the Round Robin process-assignment method for the Global team.

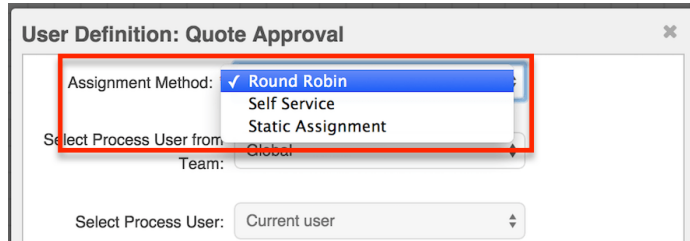

Static Assignment

Choose "Static Assignment" to assign process Activities to a specific process user. You can also select one of the following variable user types:

- **Current User** : The Current User refers to the last process user who has been defined in the process definition. If no process user has been previously defined, the Current User will be the user who is in the Assigned To field of the targeted Sugar record.
- **Record Owner** : The Record Owner is the user who is in the Assigned To field of the targeted Sugar record.
- **Supervisor** : When selected, the supervisor of the user who is in the Assigned To field of the targeted Sugar record will be prompted to execute this process activity. This relationship must be configured in the "Reports to" field of the Users module. For more information about editing User fields, please refer to the [User Management](#) page of the Administration Guide.

Static Assignment will disable the Team configuration option in this window and require only the Select Process User field to complete the configuration.

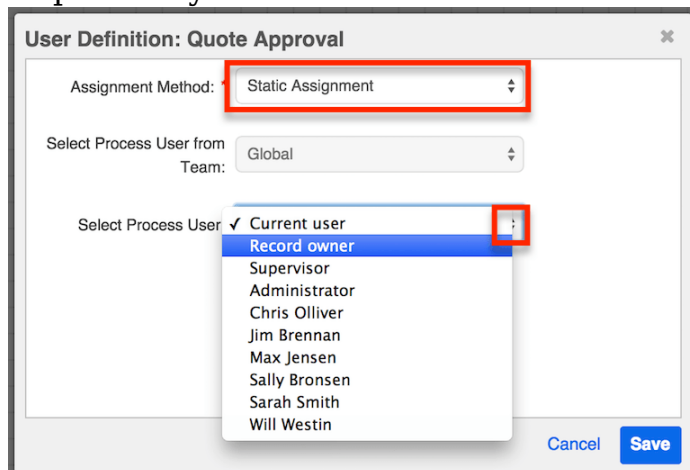

Round-Robin

Choose the Round Robin assignment method to equally distribute process activities to the [explicit members of a team](#) in a take-your-turn fashion. For example, if Jim and Sally belong to team "East," a Round Robin distribution for team East will assign the activity to Jim the first time it runs, to Sally the second time it runs, and then to Jim again on the third execution (and so on). The processing order of Round Robin activities is based on the Created By date of the user record in the Users module.

Round Robin will disable the Select Process User option in this window and require only the "Select Process User From Team" field to complete the configuration.

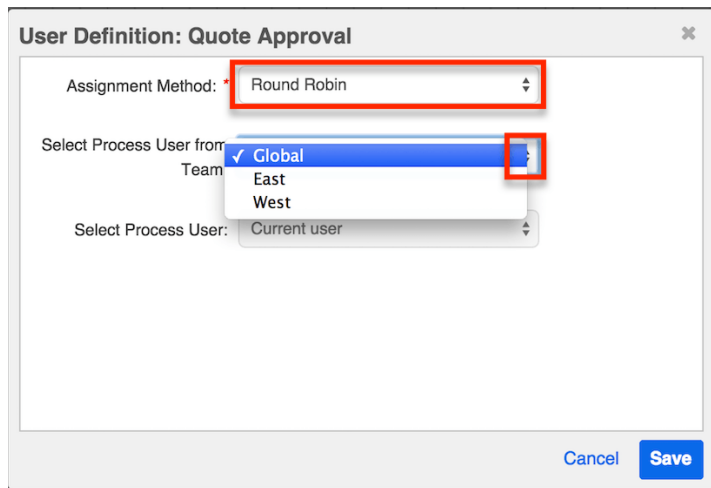

The screenshot shows a dialog box titled "User Definition: Quote Approval". It contains three dropdown menus. The first, "Assignment Method:", is set to "Round Robin" and is highlighted with a red box. The second, "Select Process User from Team:", is open, showing a list with "Global" selected (indicated by a checkmark and a blue highlight), "East", and "West". This dropdown is also highlighted with a red box. The third, "Select Process User:", is set to "Current user". At the bottom right, there are "Cancel" and "Save" buttons, with "Save" being a blue button.

Self Service

Choose the Self Service assignment method to allow any user of a specified team to claim the activity in a process. By enabling users to claim process activities as they have time for them, Self Service assignment reduces congestion in the workflow. Self Service activities that are ready to be claimed will appear in the Self Service Processes tab of the Processes dashlet.

Self Service will disable the Select Process User option in this window and require only the "Select Process User From Team" field to complete the configuration.

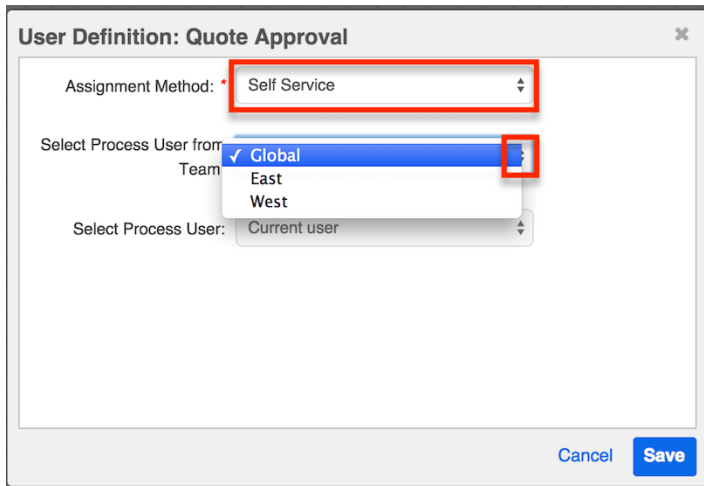

Adding Actions

Actions are automated elements used to execute a business rule, create or update a Sugar record, or designate a process user. Actions are completed by the SugarBPM engine and do not require any human interaction to execute. There are five types of actions available in the Visual Designer and they are all represented by a single icon on the design toolbar:

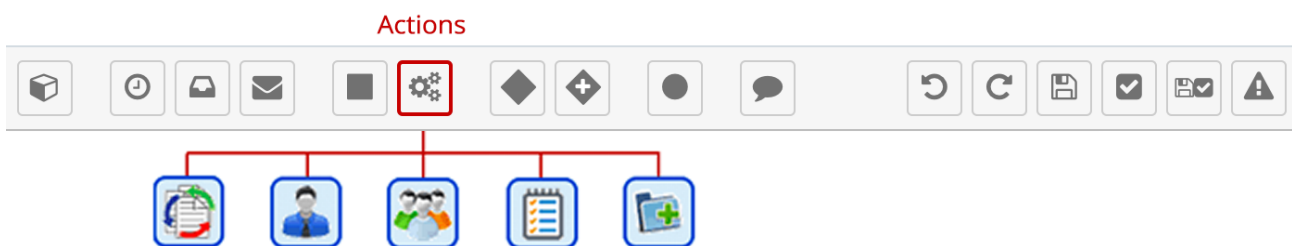

The action must be configured after adding it to the designer canvas. The five available action types are:

- [Business Rule](#)
- [Assign User](#)
- [Round Robin](#)
- [Change Field](#)
- [Add Related Record](#)

To add any of these actions to a process definition, drag and drop the Action icon from the design toolbar onto the Visual Designer canvas:

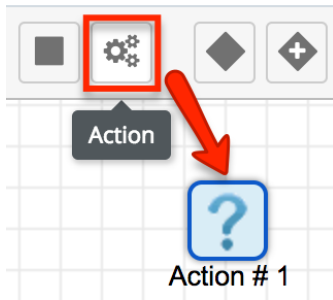

Note: The Action will have an error alert (!) icon warning you to add an outgoing sequence connector. This is normal and will disappear after you create the next element and connect it to the action. For more information about element errors, refer to the [Process Validation](#) section of this page.

The Action will display a question mark image until it has been configured. Right-click on the Action icon to configure the action type. By default, an Action element is configured as type "Unassigned". This is simply to prevent a non-configured Action from affecting the Process flow. You must choose one of the Action Types and then configure the appropriate settings.

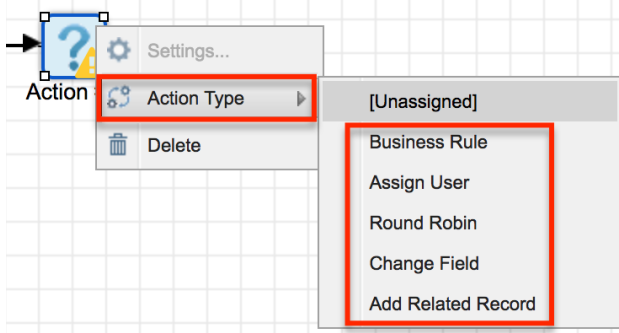

- **Settings** : This option will be grayed out until an action type is selected.
- **Action Type** : Choose the type of action this element will execute. These options are explained in detail in the remaining [Adding Actions](#) sections of this page.
- **Delete** : Remove the element from the canvas.

Business Rule

This Action type allows the administrator to select a [process business rule](#) in order to return a corresponding value. Business Rule actions must be followed by a Gateway element to analyze the rule's return value. Follow these steps to add a process business rule to the process definition:

Note: The process business rule must already be configured and saved in the [Process Business Rules](#) module in order for it to be available in the Action's

settings and must utilize the same target module as the process definition.

1. Right-click on the Action icon and then select Action Type > "Business Rule":
2. The Action's icon will change to:



3. Right-click on the icon again and choose "Settings":

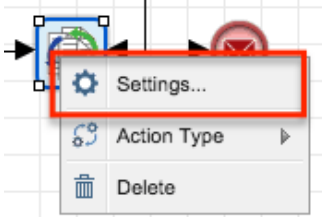

4. Select the appropriate process business rule and then click the Save button. Please note that the Rule dropdown list will only display rules that were configured for the same target module as the process definition's target module.

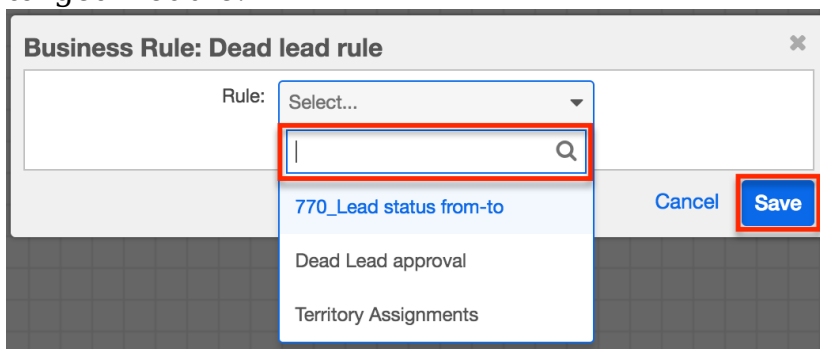

5. Now place a gateway element to the right of the business rule icon. Connect the business rule action to the gateway using a [sequence connector](#).
Note: The gateway element is required in conjunction with a business rule action.
6. Determine the number of possible outcomes for the business rule. Drag the corresponding elements for each icon (any combination of events, actions, or activities) to the design canvas, just to the right of the gateway.
7. Connect the gateway to these elements using [sequence connectors](#).
8. Finally, configure the gateway criteria before moving on. The gateway will evaluate all possible outcomes of the business rule and direct the flow of the process to the next element as appropriate. Please refer to the [Adding Gateway Elements](#) section of this page for more information.

Assign User

This Action type allows the administrator to specify a new process user or the user who will be responsible for the remaining part of the process. Assign User actions

should be followed by an [Activity](#) for the process user to complete. When a process reaches this point in a flow, the process user will see a line item in their Processes dashlet or Processes module list view.

Follow these steps to add an Assign User action to the process definition:

Note: If an Assign User action is not properly configured, it will stop the flow of the process.

1. Right-click on the Action icon and then select Action Type > "Assign User":

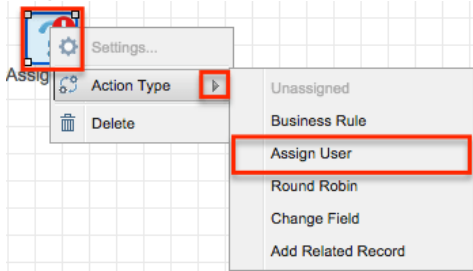

2. The Action's icon will change to:



3. Right-click on the icon and choose "Settings":

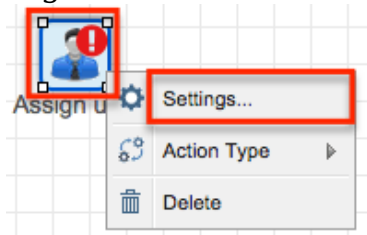

4. The Settings dialog window has two options:

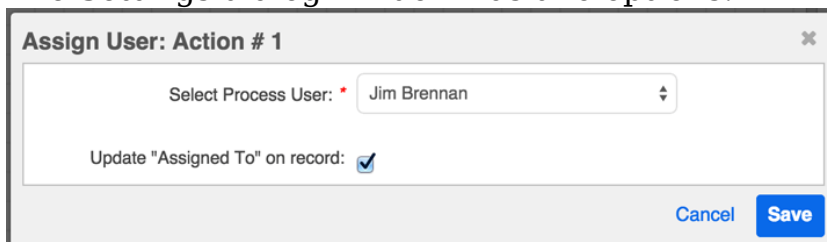

- **Select Process User** : Select the name of the user that will be responsible for the remaining process steps, until the process ends or a new process user is designated. The Dropdown list will only display users that have an Active status in the Users module.
- **Update "Assigned To" on record** : Enable this option to automatically change the Sugar record's "Assigned To" field to the process user chosen in the previous field. If the new user is not already a member of any of the teams on the record, the SugarBPM engine will append the user's private team to the record for visibility purposes.

Click "Save" to preserve these settings and return to the visual designer canvas.

Round Robin

This Action type will assign the overall process flow to the members of a team in a take-your-turn fashion. Round Robin actions are usually followed by an [Activity](#) for the process user to complete. For example, if Jim and Sally belong to team "East", a Round Robin distribution for team East will assign the upcoming activity to Jim the first time it runs, to Sally the second time it runs, and then to Jim again on the third execution (and so on).

Note: The processing order of Round Robin activities is based on the Created By date of the user record in the Users module.

Follow these steps to add a Round Robin action to the process definition:

1. Right-click on the Action icon and then select Action Type > "Round Robin":

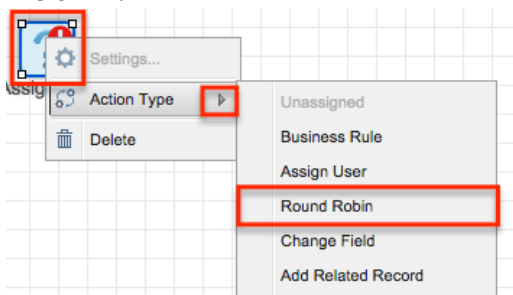

2. The Action's icon will change to:



3. Right-click on the icon and choose "Settings":

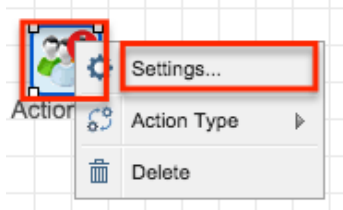

4. The Settings dialog window has two options:

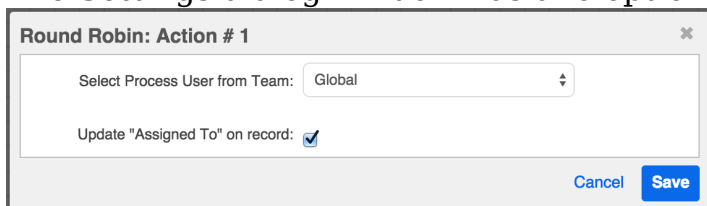

- **Select Process User from Team** : Select the name of the team

from which a member will be chosen to be responsible for the remaining process steps. If the Round Robin team is not already related to the record engaged in the process, then the record's team set will be appended with the Round Robin team.

- **Update "Assigned To" on Record** : Enable this option if the Sugar record's Assigned To field should also be updated according to the team member chosen in the previous field.
5. Click "Save" to preserve these settings and return to the visual designer canvas.

Change Field

This Action type will let you change the value of one or more fields on the target record, on records related to the target record, or on records related to that related record. Please note that calculated fields, including the Forecast field in the Revenue Line Items module (or in the Opportunities module if Revenue Line Items are disabled), cannot be modified by a Change Field action.

Note: If a Change Field action is not properly configured, the flow will ignore the action and continue running without changing any fields.

Follow these steps to add a Change Field action to the process definition:

1. Right-click on the Action icon and then select Action Type > "Change Field":

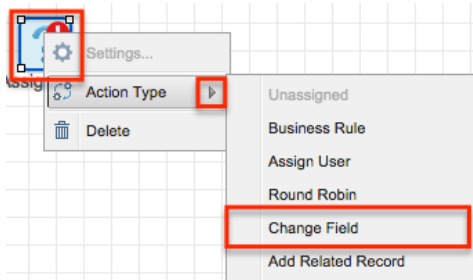

2. The Action's icon will change to:



3. Right-click on the icon again and choose "Settings":

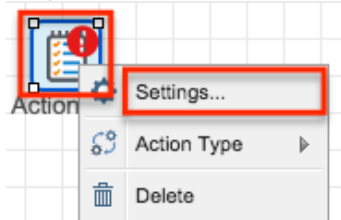

4. The Change Fields window will appear. The Module field will be pre-populated according to the target module specified in the process

definition's record view, and that module's available fields will be listed in the Fields section below.

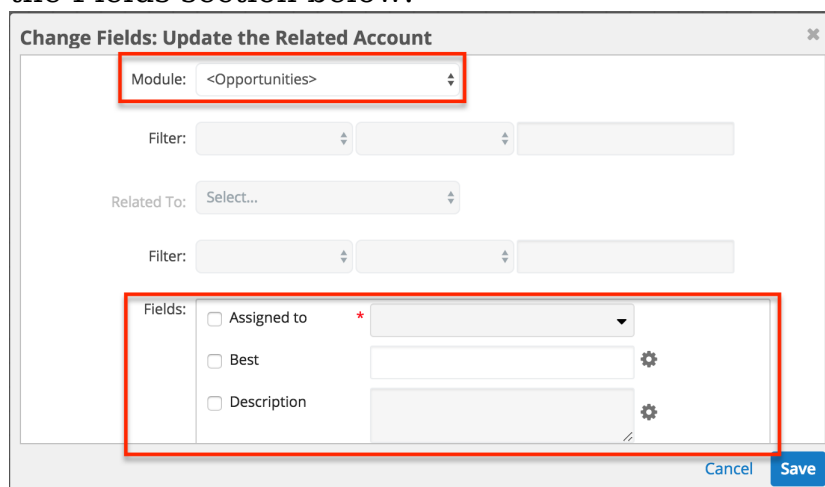



There are also several options that will allow you to change one or more fields on a one-away or two-away record related to the target module. The options are as follows:

- **Module** (required) : Select the first-level module relationship to the record you want to modify.
 - If the record you want to modify is the target record, then simply leave the target module selected (default).
 - If the record you want to modify is a one-away record (e.g. a record that is directly related to the target record), then select the module with the record that you want to modify.
 - If the record you want to modify is a two-away record (e.g. a record that is related to a record that is directly related to the target record), then select the intermediate module here; not the target module nor the module that contains the record you want to modify.
- **Filter** : Optionally, apply a filter to the first-level module. For example, if the first-level module is Cases, you can restrict the criteria to apply to only open cases by setting "Status > is not equal to > Closed". Please note that, if the first-level module is on the one side of a one-to-one or many-to-one relationship, then the filter option will be grayed out, as the filter can be defined in the criteria of the event that precedes the action.
- **Related To** : Optionally, select a second-level module relationship. For example, set the second-level module to Accounts if you want to modify the accounts that are related to the records in the first-level module field.
- **Filter** : Optionally, apply a filter to the second-level module records. Please note that, if the first-level module is on the one side of a one-to-one or many-to-one relationship, then the filter option will be grayed out.
- **Fields** (required) : Finally, select the fields you want to modify on

the record, as explained in the next step.

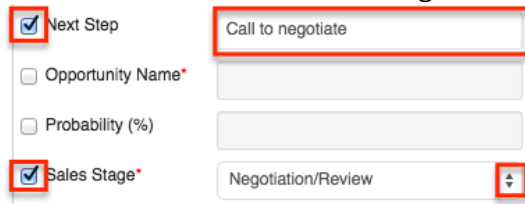
5. To have the process definition update a field, you must first enable that field for editing by clicking inside the field's adjacent checkbox. Each field will be locked from editing until its corresponding checkbox is selected.



6. Enter or select the desired field value. Fields that display a Settings  icon support [advanced configurations](#).
7. Click "Save" to preserve these settings and return to the Visual Designer canvas.

Advanced Configuration Options for Change Field Actions

The following field types support advanced configuration options for Change Field actions, as indicated by the Settings  icon.

Text Fields

To specify the value of a text field, use any combination of Sugar field variables and text strings. For example, to append the Opportunity's Likely Amount to an existing Opportunity name, follow these steps. In this example, a \$100 opportunity named "5 Widgets" will be updated to "5 Widgets - \$100".

1. Enable the checkmark next to the field name that you want to edit, and then click on the Settings icon next to the empty field:

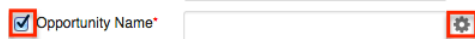

2. Click on Opportunities Fields > Opportunity Name. This will insert a variable into the Opportunity Name field that references the current value of the field when the corresponding process reaches this point in the flow.

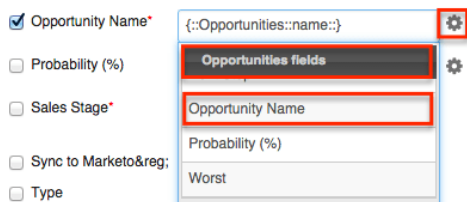

3. Place the cursor inside the field immediately after the variable and type a space or hyphen character for formatting.
4. Click on the Settings icon again.
5. Click on Opportunities Fields > Likely to insert a second field variable.

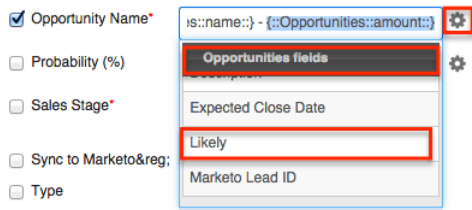

6. When the formula is complete, the field value container will look similar to this:

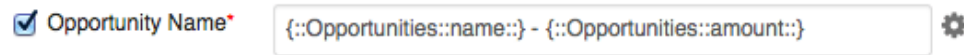

Note: If a Change Field action references a field variable that is also changed by the action, the variable will reflect the value of the field before the change field action executes. For example, if the action changes the Probability field to {probability + 1}, and the same action also inserts the Probability field variable into the Description field, after saving, the description will display {probability} and the Probability field will equal {probability + 1}.

Number Fields

To create a calculated value for number fields, use some combination of operators, Sugar variables, and constants. For example, to calculate the Worst Amount field to contain 50% of the value of the Likely Amount field, follow these steps:

1. Enable the checkmark next to the field name that you want to edit, and then click on the Settings icon next to the empty field:

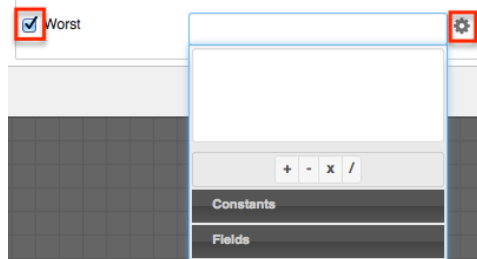

2. In the criteria builder, place the variable for "Likely Currency" onto the criteria window by clicking on Fields > Opportunities > Likely Currency. This will automatically add the variable to the window:

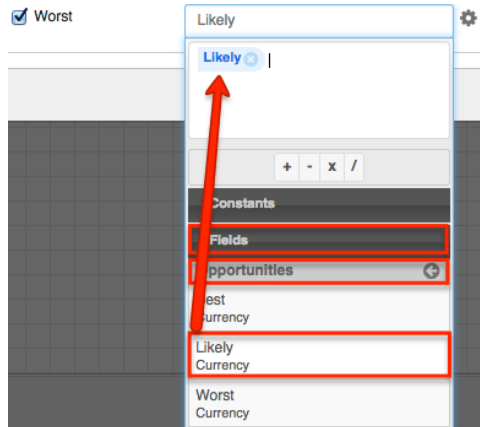

3. Click on the multiply (x) operator from the Operators list to add it to the formula window:

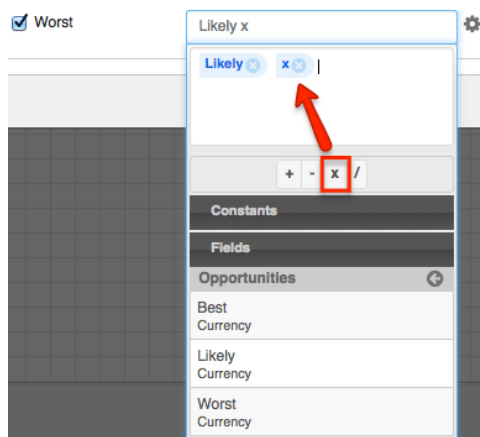

4. Now tell the criteria builder to multiply the Likely amount by half, or 0.5. Click on Constants > String, Number and Boolean > type "0.5" in the Value field (with no quotes) and then click "Add Number" to move the value to the criteria builder canvas.

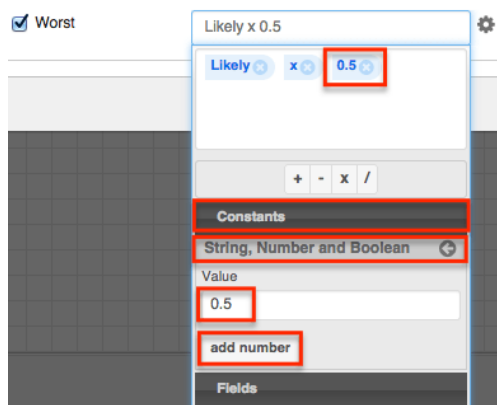

5. When the formula is complete, click away from the criteria builder window to see the formula in the field value container:

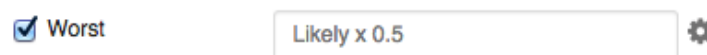

Date Fields

Date and datetime fields will reveal a criteria builder where the admin can calculate a particular value. Please see the Fixed Dates section of the [Creating Conditions for Events and Actions](#) documentation on this page to learn how to configure date fields.

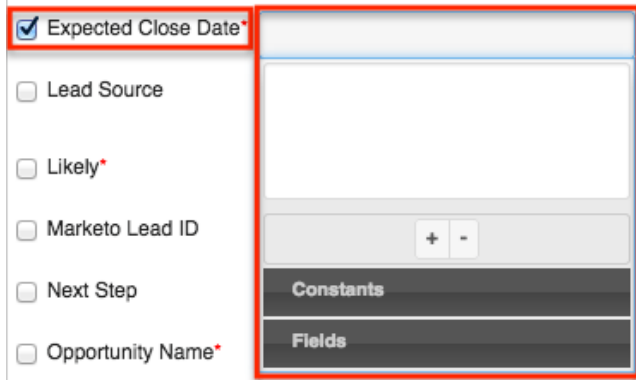

The image shows a user interface for configuring criteria. On the left, there is a list of fields with checkboxes: 'Expected Close Date*' (checked), 'Lead Source', 'Likely*', 'Marketo Lead ID', 'Next Step', and 'Opportunity Name*'. On the right, a criteria builder panel is shown, which includes a search bar, a plus/minus button, and two sections labeled 'Constants' and 'Fields'. The 'Expected Close Date*' field and the criteria builder panel are highlighted with a red border.

User Fields

For Change Field actions, user fields support the following variable user types relative to the record that triggered the running process:

- **Created by User** : The user who created the trigger record
- **Current User** : The user who is defined as the process user within the process definition
- **Last Modified by User** : The user who last modified the trigger record
- **Record Owner** : The user assigned to the trigger record
- **Supervisor** : The supervisor of the user assigned to the trigger record

Add Related Record

This Action type will create a new Sugar record and relate it to the target Sugar record or to a record related to the target record. Please note that the values of calculated fields, including the Forecast field in the Revenue Line Items module (or in the Opportunities module if Revenue Line Items are disabled), cannot be directly defined by an Add Related Record action.

When the SugarBPM engine creates a new record, the record's assigned user will receive an assignment notification email if notifications are enabled in Sugar's system settings and the user has enabled notifications in their user profile. For more information on assignment notifications, please refer to the [Getting Started](#) documentation in the Application Guide and the [Email](#) documentation in the Administration Guide.

Note: If an Add Related Record action is not properly configured, the flow will

ignore the action and continue running without creating a new record.

Follow these steps to add an Add Related Record action to the process definition:

1. Right-click on the Action icon and then select Action Type > "Add Related Record":

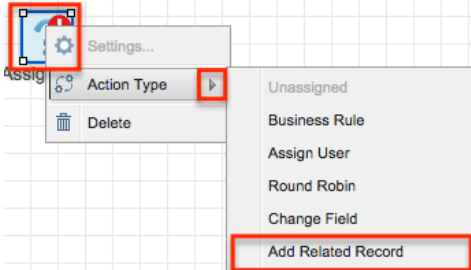

2. The Action's icon will change to:



3. Right-click on the icon and choose "Settings":

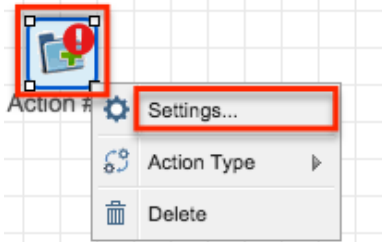

4. The Add Related Record window will appear. The Module field will present the potential options in alphabetical order, with the topmost module's available fields listed in the Fields section below.

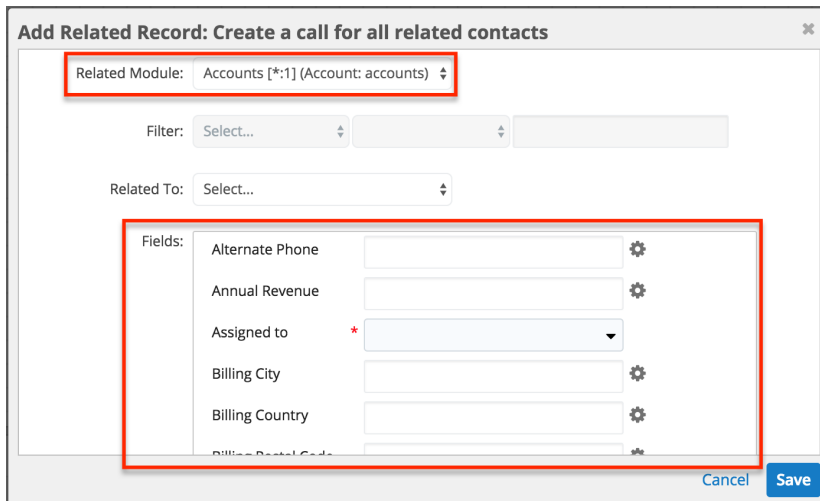
A screenshot of the 'Add Related Record' dialog box. The title is 'Add Related Record: Create a call for all related contacts'. The 'Related Module' field is set to 'Accounts [*:1] (Account: accounts)'. The 'Filter' field is set to 'Select...'. The 'Related To' field is set to 'Select...'. The 'Fields' section is highlighted in red and contains a list of fields: Alternate Phone, Annual Revenue, Assigned to, Billing City, Billing Country, and Billing Postal Code. The 'Assigned to' field has a red asterisk. The 'Save' button is highlighted in blue.

The following options will allow you to create a related record or a record in a two-way module related to the target module:

- **Related Module** (required) : Select the first-level module relationship to the record you want to create.
 - If the record you want to create is directly related to the target record, then select that module here.

- If the record you want to create is a two-away record (e.g. a record that will be related to a record that is directly related to the target record), then select the intermediate module here; not the target module nor the module where you want to create a new record.
 - **Filter** : If the record you want to create is a two-away record, optionally, apply a filter to the first-level module. For example, if the first-level (i.e. one-away) module is Contacts, you can create related call records for only the related contacts where "Do Not Call > is not equal to > Yes". Please note that, if the first-level module is on the one side of a one-to-one or many-to-one relationship, then the filter option will be grayed out.
 - **Related To** : Optionally, select a second-level module relationship. For example, set the second-level module to Calls if you want to create calls related to the contact records in the first-level Related Module field.
5. Complete the fields that the SugarBPM engine will populate in the new record. Any fields that are required by the module (indicated by a red asterisk) must be configured in this step. The following screenshot shows an Add Related Record action configured for a Cases process to create call records related to any contacts that are related to the target case and do not have Do Not Call set.

The screenshot shows a configuration window titled "Add Related Record: Create a call for case contacts if DNC=no". It contains the following fields and options:

- Related Module:** Contacts [*:M] (Contacts: contacts)
- Filter:** Do Not Call is not equal to (checked)
- Related To:** Calls [*:M] (Calls: calls)
- Fields:**
 - Assigned to: Current User (required, indicated by a red asterisk)
 - Description: (empty text field)
 - Direction: Inbound
 - Duration Hours: 0 (required, indicated by a red asterisk)
 - Duration Minutes: 15 (required, indicated by a red asterisk)

Buttons for "Cancel" and "Save" are located at the bottom right of the window.

- Fields that display a Settings  icon support [advanced configurations](#).
6. Click "Save" to preserve these settings and return to the Visual Designer canvas.

Advanced Configuration Options for Add Related Record Actions

The following field types support advanced configuration options for Add Related Record actions, as indicated by the Settings  icon.

Text Fields

To specify the value of a text field, use any combination of Sugar field variables and text strings. For example, when creating a follow-up task related to a target opportunity, follow these steps to use the opportunity's Name field in the subject of the task. In this example, a task related to an opportunity named "5 Widgets" will have the subject "Follow up - 5 Widgets".

1. Click on the Settings

⚙ icon next to the empty field, then choose Opportunities Fields > Opportunity Name. This will insert a variable into the Subject field that references the opportunity when the corresponding process reaches this point in the flow.

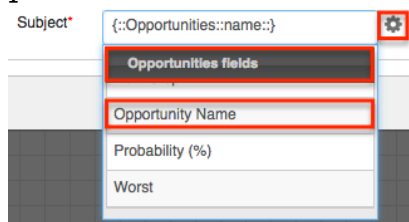

2. Place the cursor inside the field immediately before the variable and type "Follow up: " Include a space or hyphen character for formatting. When the formula is complete, the field value container will look similar to this:

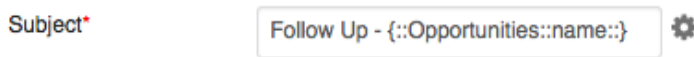

Number Fields

To create a calculated value for number fields, use some combination of operators, Sugar variables, and constants. For example, to calculate the Worst Amount field to contain 50% of the value of the Likely Amount field, follow these steps:

1. Click on the settings

⚙ icon next to the empty field:

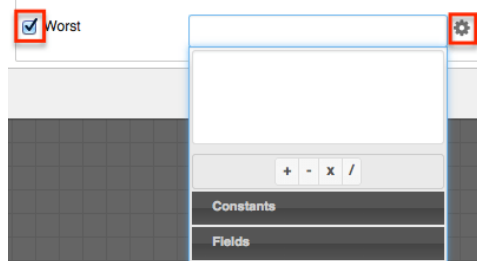

2. In the criteria builder, place the variable for "Likely Currency" onto the criteria window by clicking on Fields > Opportunities > Likely Currency. This will automatically add the variable to the window:

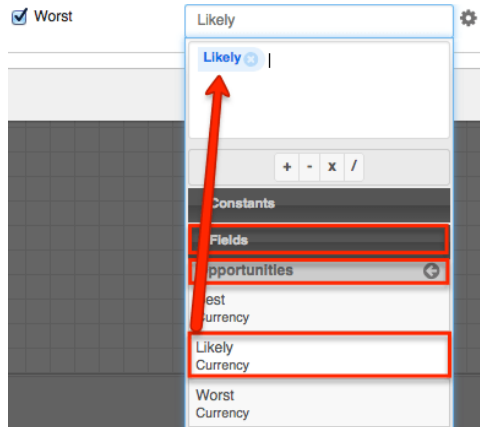

3. Click on the multiply (x) operator from the Operators list to add it to the formula window:

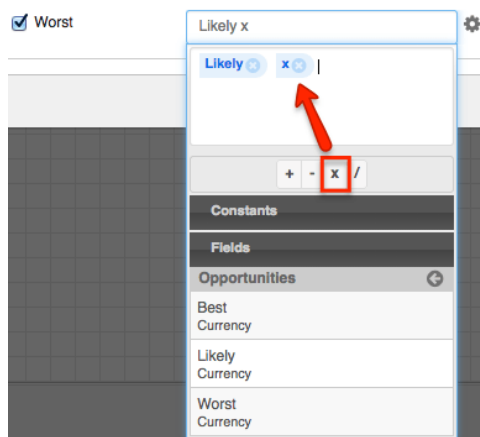

4. Now tell the criteria builder to multiply the Likely amount by half, or 0.5. Click on Constants > String, Number and Boolean > type "0.5" in the Value field (with no quotes) and then click "Add Number" to move the value to the criteria builder canvas.

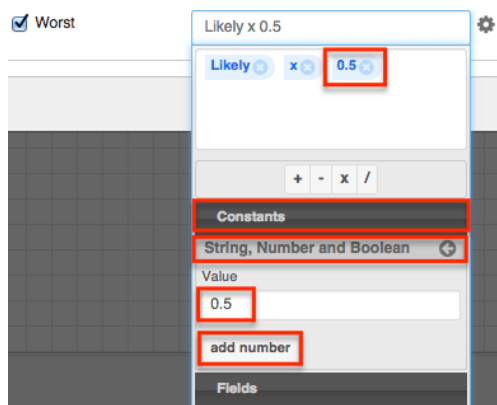

5. When the formula is complete, click away from the criteria builder window to see the formula in the field value container:

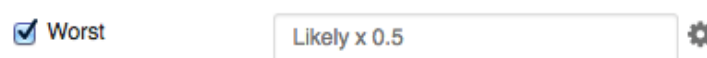

Date Fields : Date and datetime fields will reveal a criteria builder where the admin can calculate a particular value. Please see the Fixed Dates section of the

[Creating Conditions for Events and Actions](#) documentation on this page to learn how to configure date fields.

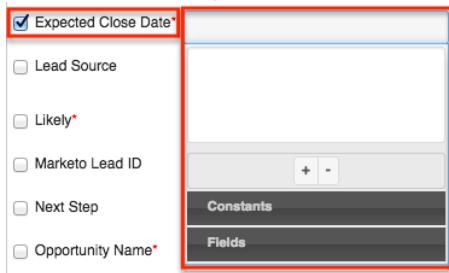

User Fields : For Add Related Record actions, user fields support the following variable user types relative to the record that triggered the running process:

- **Created by User** : The user who created the trigger record
- **Current User** : The user who is defined as the process user within the process definition
- **Last Modified by User** : The user who last modified the trigger record
- **Record Owner** : The user assigned to the trigger record
- **Supervisor** : The supervisor of the user assigned to the trigger record

Adding Gateway Elements

Gateways are connective elements used to control the flow of a process via merging and splitting. When a single activity may result in several different outcomes, a Gateway serves as a splitting mechanism (i.e., divergent element). When several activities may result in a common outcome, a Gateway serves as a merging mechanism (i.e., convergent element).

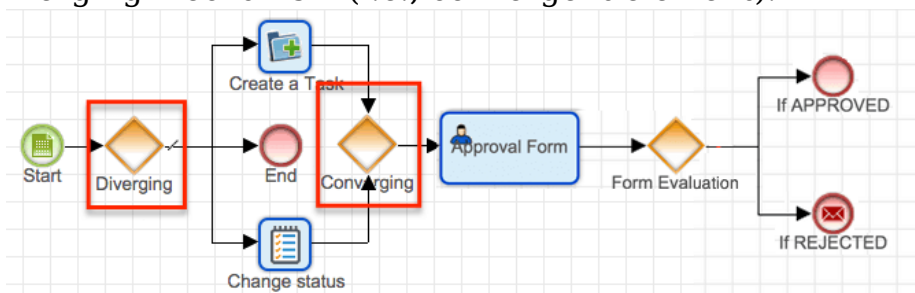

A Gateway is represented as a diamond in the Visual Designer and by the fourth group of icons on the design toolbar. There are two icons that each enable at least one type of configurable divergent or convergent moment.

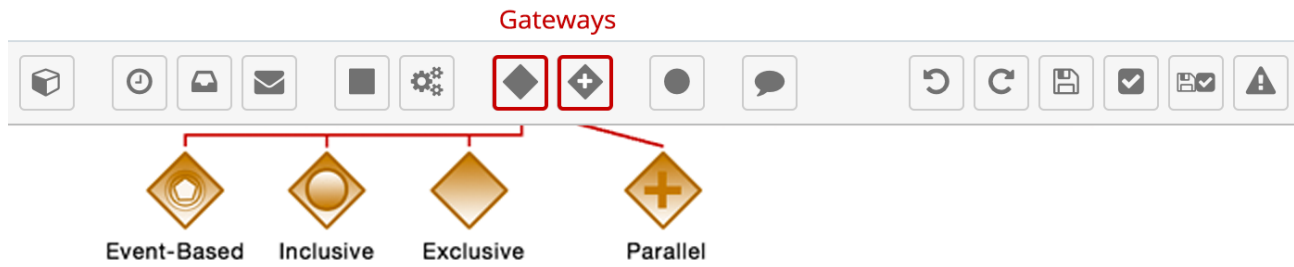

To add a Gateway element to a process definition, drag and drop one of the two Gateway icons onto the designer canvas. Right-click on the diamond-shaped icon that appears in order to define a Gateway type, direction, and configure its settings.

The four types of Gateways are explained in the following sections.

Gateway Type	Divergent	Convergent	Use
Exclusive Gateway	<input type="checkbox"/>	<input type="checkbox"/>	When divergent, determines a single outgoing path based on data conditions; When convergent, accepts only the flow that reaches it first
Inclusive Gateway	<input type="checkbox"/>		Evaluates all criteria to determine one or more outgoing paths
Parallel Gateway	<input type="checkbox"/>	<input type="checkbox"/>	When divergent, begins the concurrent execution of all outgoing paths; When convergent, waits for completion of all concurrent paths
Event-Based Gateway	<input type="checkbox"/>		Evaluates Wait events and Receive Message events, creating a "race"

Note: A convergent gateway is usually required after a divergent gateway, but not always. Carefully consider the outcome for each path in all possible user scenarios and be sure to use the appropriate End event(s). When divergent paths do not converge, you will most likely need to use [Terminate Process](#) End events. For more information on End events, please refer to the [Adding End Events](#) section of this page.

Default Sequence Flows

Default sequence flows represent the path your process takes when none of the defined gateway conditions evaluate to true.

- There must be one default sequence flow defined per divergent gateway object.
- Define the default flow before configuring any other criteria for the outgoing flows. Because default flow elements require no conditions, the default flow element will not have a corresponding Criteria field in the Gateway's criteria builder pop-up.
- Failure to define a default sequence flow will result in an element error, as explained in the [Process Validation](#) section of this page.

To define a default sequence flow, first, connect the Gateway to all possible outcome elements. Next, right-click on the Gateway icon and hover over the Default Flow option. A menu will appear listing all of the potential flow routes from the Gateway. Select the element that should occur when no criteria are met by the others.

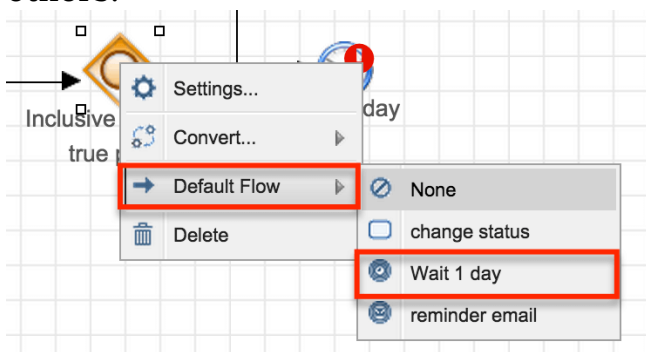

After defining the default flow, the sequence connector leading to the default flow element will be distinguished by a small hash mark through the connector line:

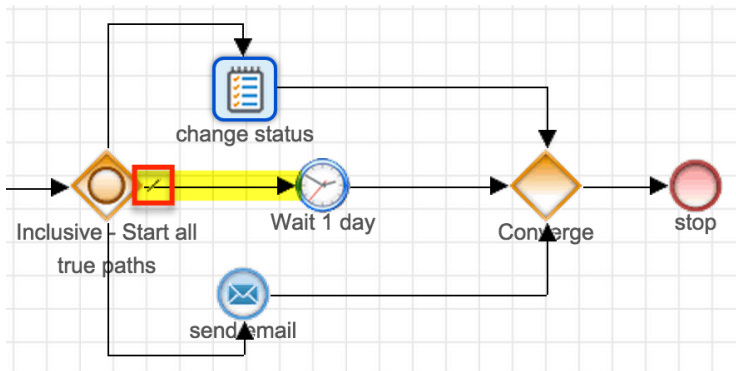

For more information on interacting with sequence connectors, please refer to the [Sequence Flow](#) section of this documentation.

Exclusive Gateways



Exclusive gateways can be used to diverge or converge flow elements in a process. Exclusive gateways will evaluate several conditions but only direct the flow to or from a single path in the flow.

Divergent Exclusive Gateway

Only one path will succeed from an Exclusive gateway, and it will be the one that first accomplishes its start criteria.

Note: You must define a [default sequence flow](#) for divergent Exclusive gateways to account for situations where all criteria are false.

- If several criteria are true, the flow will be routed through the first (topmost) flow that evaluates as true.
- If no criteria are true, the flow will be routed through the [default flow](#). If you have not set a [default flow](#), the process definition will be blocked by this element.

Follow these steps to configure a divergent Exclusive gateway:

1. Drag the Exclusive gateway icon onto the designer canvas.
2. A divergent Gateway requires two or more subsequent elements (any combination of intermediate events, end events, actions, and/or activities). These must be placed on the canvas and [connectors](#) must join the elements

on the canvas before the Gateway can be configured.

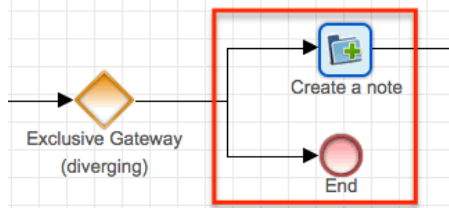

3. Once the Gateway has been connected to the subsequent elements, right-click on the Gateway icon and select Direction > Diverging:

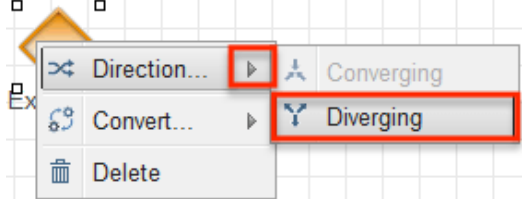

4. Specify a [default flow](#) for the Gateway. If no criteria are fulfilled, the flow will be routed through the default one. From the visual designer canvas, right-click on the Gateway icon and hover over the Default Flow option. A menu will appear listing all of the potential flow routes from the Gateway. Select the element that should occur when no criteria are met by the others.

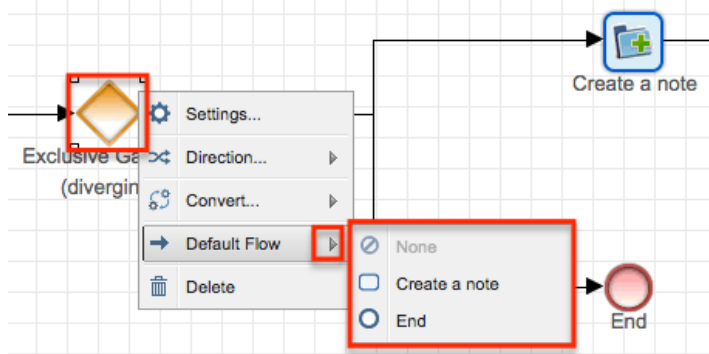

Note: The route set as default will not appear in the Criteria configuration window (step 6).

5. Right-click on the element again and select the option "Settings".

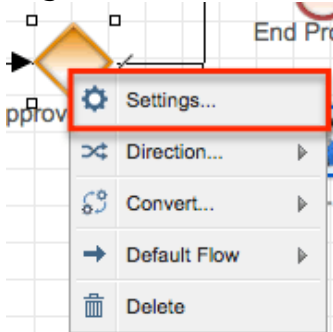

6. A pop-up window will appear with a separate Criteria field for each potential outcome except the default one, which requires no criteria.
 - Click inside each criteria field to display the criteria builder tool. Refer to the [Creating Conditions for Events and Actions](#) section of

this page for criteria builder instructions.

- Drag and drop the Criteria fields in descending order of priority.

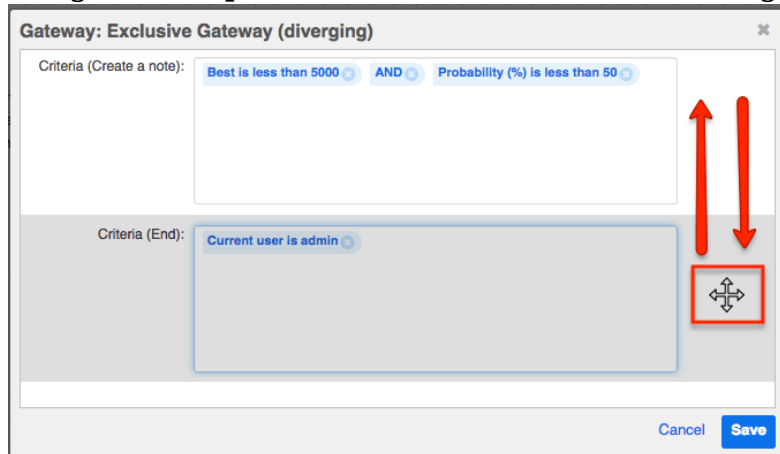

The criteria will be evaluated as they are presented in this window from top to bottom. Only one path will succeed from an Exclusive gateway, and it will be the one that first accomplishes its criteria. The remaining criteria will not be evaluated. If no criteria are fulfilled, the [default flow](#) will succeed (see step 4).

7. Click "Save" to return to the design canvas and continue building the process definition.

Note: A convergent gateway is usually required after a divergent gateway, but not always. Carefully consider the outcome for each path in all possible user scenarios and be sure to use the appropriate End event(s). When divergent paths do not converge, you will most likely need to use [Terminate Process](#) End events. For more information on End events, please refer to the [Adding End Events](#) section of this page.

Convergent Exclusive Gateway

This Gateway joins multiple paths in a single thread, but only accepts the first flow that reaches the Gateway; the other flows will not be evaluated after that. There are no settings for this element. To configure this Gateway as a convergent element, right-click on the Gateway element and select Direction > Converging:

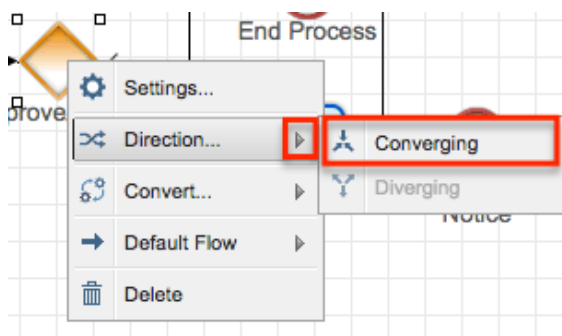

Inclusive Gateways



Inclusive gateways are divergent elements that direct a process' flow along all of the paths that accomplish their criteria. This may result in one flow or multiple flows.

Note: You must define a [default sequence flow](#) for Inclusive gateways to account for situations where all criteria are false.

- If only one set of criteria evaluates as true, the flow will follow that single path.
- If several criteria are true, the flow will be routed along all paths that evaluate as true.
- If no criteria are true, the flow will be routed through the [default flow](#). If you have not set a [default flow](#), the Process Definition will be blocked by this element.

Follow these steps to configure an Inclusive gateway:

1. Drag the Exclusive gateway icon onto the designer canvas.
2. Right-click on the Gateway icon and select Convert > Inclusive Gateway.

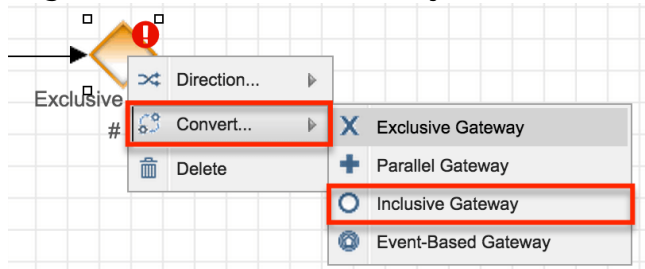

- The icon will transform from an empty diamond to a diamond containing a circle.
- Please note that the label will not automatically update and may still be labeled as "Exclusive". Edit this label as appropriate for your process.



3. A divergent Gateway requires two or more subsequent elements (any combination of intermediate events, end events, actions, and/or activities). These must be placed on the canvas and [connectors](#) must join the elements on the canvas before the Gateway can be configured.

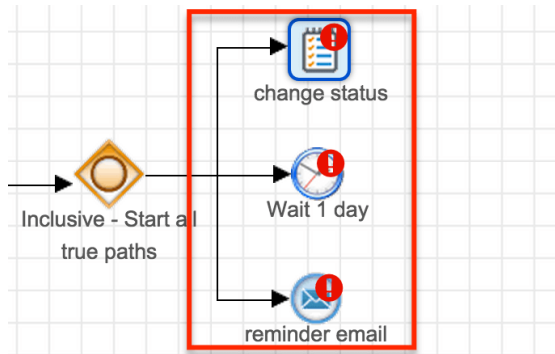

- Once the Gateway has been connected to the subsequent elements, specify a [default sequence flow](#) for the Gateway. If no criteria are fulfilled, the flow will be routed through the default one. From the visual designer canvas, right-click on the Gateway icon and hover over the Default Flow option. A menu will appear listing all of the potential flow paths from the Gateway. Select the element that should occur when no criteria are met by the others.

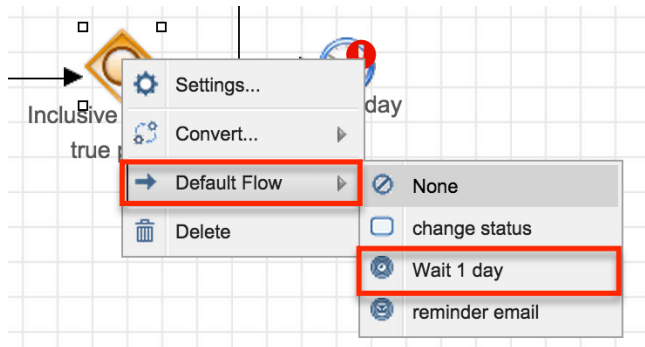

Note: The path set as default will not appear in the Criteria configuration window (step 6).

- Right-click on the Gateway again and select "Settings".

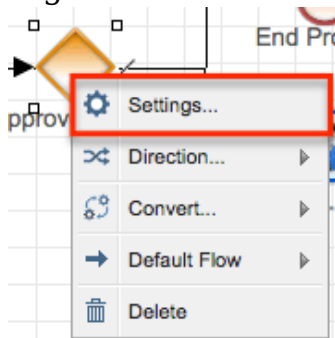

- A pop-up window will appear with a separate Criteria field for each potential outcome except the default one, which requires no criteria. Click inside each criteria field to display the criteria builder tool. Refer to the [Creating Conditions for Events and Actions](#) section of this page for criteria builder instructions.
- Click "Save" to return to the design canvas and continue building the process definition.

Note: A convergent gateway is usually required after a divergent gateway, but not

always. Carefully consider the outcome for each path in all possible user scenarios and be sure to use the appropriate End event(s). When divergent paths do not converge, you will most likely need to use [Terminate Process](#) End events. For more information on End events, please refer to the [Adding End Events](#) section of this page.

Parallel Gateways



Use a Parallel gateway in a complex process that has multiple things happening all at once (or "parallel" to each other). Unlike other gateways, there is no evaluation inside this gateway; it simply tells the process that two or more flows are about to happen at the same time.

Parallel gateways can be divergent or convergent. Divergent Parallel gateways will direct parallel flows, whereas convergent Parallel gateways will receive parallel flows. The same gateway is used for diverging and converging:

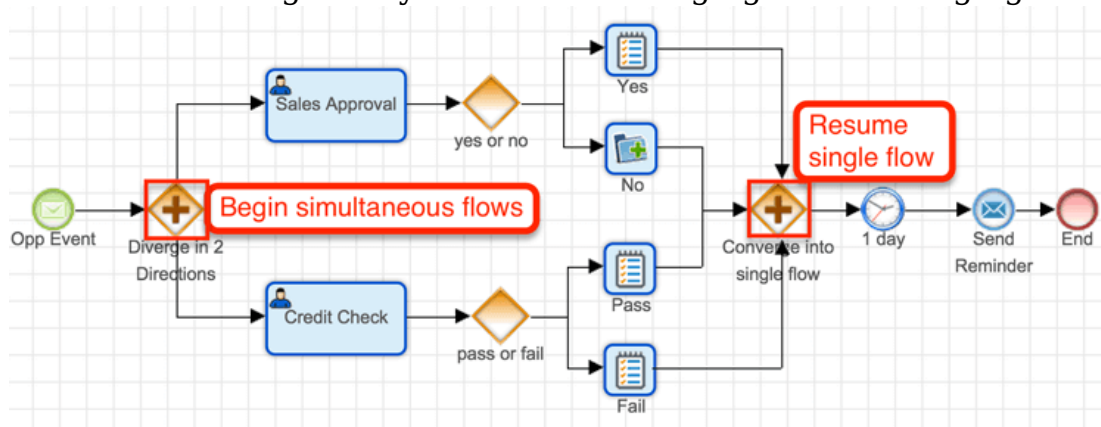

Divergent Parallel Gateway

The divergent Parallel gateway divides the flow into two or more elements in parallel until a subsequent (convergent) Parallel gateway or until the paths are legally terminated via End events. For example, in the screenshot above, the process requires approval from the sales manager and a credit check from the accounting department. If you tried to use an Exclusive gateway for this, it would enforce only one of these options (sales approval OR credit check). But using a Parallel gateway, the process can branch off in both directions at the same time and then converge later. When the parallel flows reconvene, use a convergent Parallel gateway to merge them.

Note: All divergent Parallel gateways must have a convergent Parallel gateway to close out the multiple paths; otherwise, the engine leaves them active.

The following example demonstrates a process where the Parallel gateway is leveraged to kick off two separate functions. The top flow starts the approval and specifies behavior for approve/reject response. The bottom flow starts a separate flow and eventually, a convergent parallel gateway is used to resume a singular flow for the process.

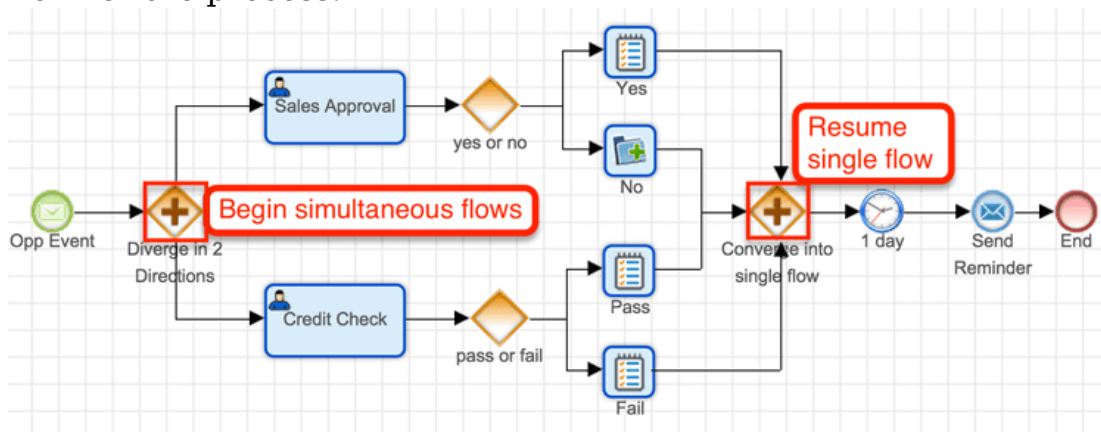

Note: A convergent gateway is usually required after a divergent gateway, but not always. Carefully consider the outcome for each path in all possible user scenarios and be sure to use the appropriate End event(s). When divergent paths do not converge, you will most likely need to use [Terminate Process](#) End events. For more information on End events, please refer to the [Adding End Events](#) section of this page.

Convergent Parallel Gateway

A convergent Parallel gateway joins multiple paths into a single thread. The process flow will re-commence only when all of the flows that converge into this gateway have arrived. There are no configuration settings for this gateway.

Event-Based Gateways



Event-based gateways are used to create a "race" condition between Activities, Wait events, and Receive Message events that occur immediately after the gateway. Event-based gateways stop the process flow until one of the activities or events have completed per the following guidelines:

-
- Receive Message events are complete when their condition is met.
 - Wait events are complete when they have satisfied the entirety of their set duration.
 - Activity elements are complete when the activity's form has been approved, rejected, or routed, or if the activity gets reassigned to another user via "Select New Process User".

As soon as the first element completes, the flow direction then continues along the path that completed first and the incomplete paths are dropped. There are no configuration settings for an event-based gateway, but the following supporting elements are required:

- A combination of two or more form Activities, Wait events, or Receive Message events to evaluate immediately after the gateway.
- A [convergent exclusive gateway](#) must close out the multiple paths; otherwise, the engine leaves them active.

To add an Event-based gateway to your process design, drag and drop the gateway element onto the canvas. By default, it will be set as Exclusive; to convert it into event-based, right-click on the icon and select Convert > Event-Based Gateway.

Adding End Events

End events are represented by the fifth icon grouping on the design toolbar. There is one icon that can be configured three different ways after placing it on the Designer Canvas.

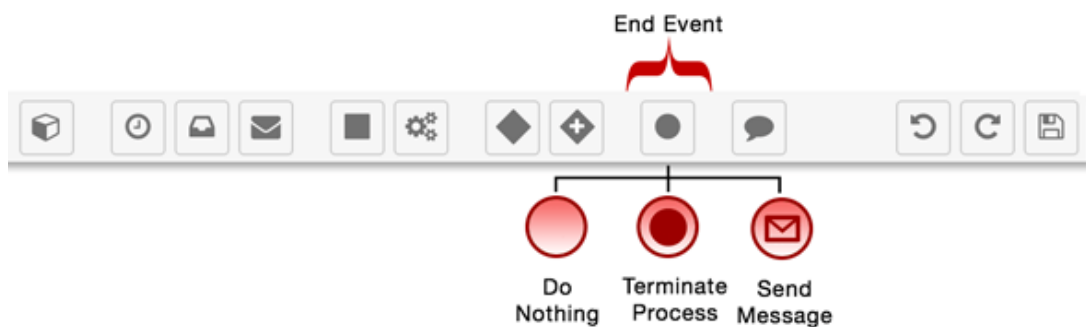

To define an End event type, drag the End event icon onto the Designer Canvas and then right-click on the red circle. Choose "Result" from the menu, and then find the appropriate End event type. Note that the active End event type will be grayed out because it is already selected, and the default type is "Do Nothing".

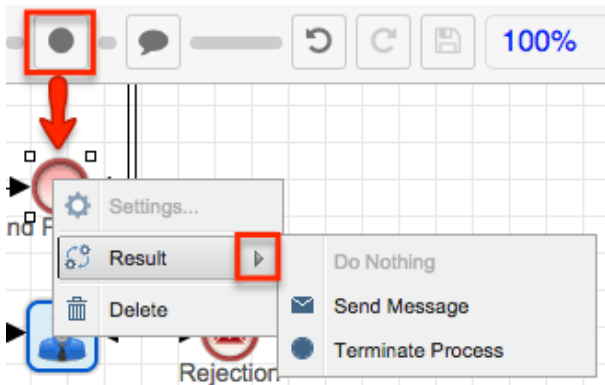

The three types of End event are:

Do Nothing

Most often used for sequential processes, this event ends a thread of the Process Definition without doing anything. It will not affect parallel threads that may be running simultaneously in the process. Those threads will continue to run uninterrupted by the Do Nothing End event. This event does not need any configuration; it is set by default when you drag and drop an End event onto the canvas.

To create a Do Nothing End event, drag and drop the End event icon into the canvas. Right-click on the element icon and confirm that "Do Nothing" is grayed out by default in the Result menu, indicating that it is the active End event type. If it is not grayed out, click on "Do Nothing" to make it the active End event type.

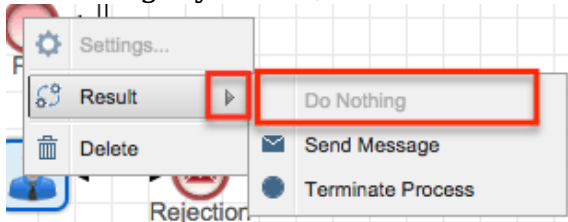

Terminate Process

Most often used for parallel processes, this event terminates the flow of the branch for which it is designed while simultaneously terminating the entire process, regardless of any parallel events in the process definition. The Terminate Process event does not need any configuration.

To create a Terminate Process End event, drag and drop the End event icon into

the canvas. Right-click on the element icon then choose "Terminate Process" in the Result menu to make it the active End event type.

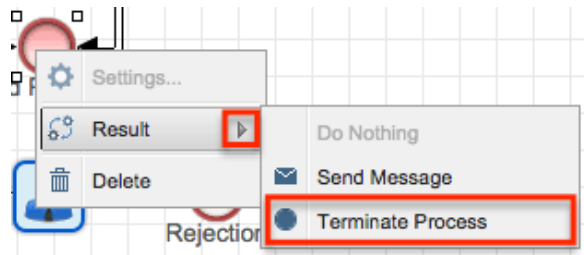

Send Message



The Send Message End event will signify the end of a process by emailing a message created in the [Process Email Templates](#) module to specified recipients. When a Send Message end event has multiple incoming paths, it will send an email message for each path coming into it. If you want the message to be sent only once, then you must use a converging gateway in front of the end event.

Please note that SugarBPM can only send email templates created in the Process Email Templates module and cannot send email messages created in any other part of the Sugar application. If no Process Email Template is specified in the event configuration, then the Process will terminate but no message will be sent. If your email template has been configured with a variable to show the old value of a changed field, it is important to strategically position the Send Message event within your process definition's design. For more information, refer to the [Process Email Templates](#) documentation.

Note: Send Message End events require the SugarBPM Scheduled Job scheduler to execute. If schedulers are not running, the message will not be sent. For more information, please refer to the [SugarBPM](#) documentation.

To create a Send Message End event, follow these steps:

1. Drag and drop the End event icon into the canvas. Right-click on the element icon and then choose "Send Message" in the Result menu to make this the active End event type.

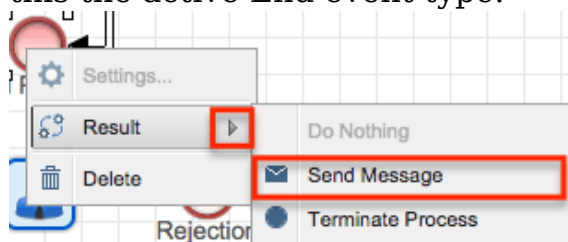

2. Right-click on the canvas icon and select the option "Settings" to configure

the event. A new window will appear:

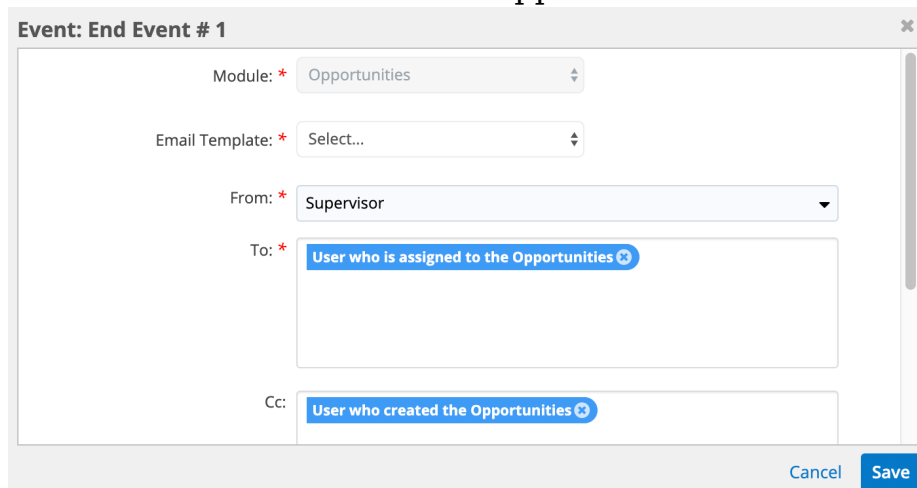

The screenshot shows a configuration window titled "Event: End Event # 1". It contains the following fields:

- Module:** * Opportunities
- Email Template:** * Select...
- From:** * Supervisor
- To:** * User who is assigned to the Opportunities
- Cc:** * User who created the Opportunities

Buttons for "Cancel" and "Save" are located at the bottom right of the window.

- **Module** : (read-only) This is the module that was set as the target module for the process definition and which also must be the target module for the email template.
- **Email Template** : (required) Choose an email template from the dropdown list. This list will only show templates that use the target module specified in the previous field.
- **From** : (required) Choose who should be shown as the sender of this email. Options include users associated with the target record (e.g. Record Owner), System Email, any Sugar user, and any outgoing email account configured in Sugar. If you select a user, the name of the sender will be the user's first and last name, and the email address of the sender and reply-to email address will be their primary email address. For details on how these fields are set for outgoing email accounts, see the [Emails](#) documentation.
- **To, Cc, Bcc** : (required) Specify the message's recipients. Click inside the text area to select variable users, the explicit members of a Sugar team, and/or type one or more email addresses. Please refer to the [Working With Recipient Fields](#) section of this page for more information about configuring the To, Cc, and Bcc fields.

Note: Marketing and campaign emails should never be sent using SugarBPM. This is because SugarBPM does not respect the subject's request to opt out, which raises a liability concern.

Setting Conditions

Conditional criteria may be defined for elements in a process definition based on [process business rules](#), response forms, field values, related modules, specified users, and date intervals.

Creating Conditions for Events and Actions

Start event, End event, and all types of Action elements will display conditions as logical or mathematical operations, depending on the type of field that is under evaluation.

The available conditional components are:

- [Logical Operations](#) : Used in criteria builders for text and other non-numerical field types.
 - [Module Field Evaluation](#)
 - [User Evaluation](#)
- [Mathematical Operations](#) : Used in criteria builders for date and numerical field types.
 - [Fixed Date](#)
 - [Time Span](#)
 - [Sugar Date Variables](#)

Logical Operations

Logical operations utilize the AND, OR, and NOT operators in conjunction with the [Module Field Evaluation](#) and [User Evaluation](#) options to specify conditions for an event. For example, a Start event for opportunities may be limited to only opportunities containing a certain sales stage. Logical operations are defined inside a criteria builder in the process definition's design view.

Note: Logical operations may be used in Start events and Send Message events.

The logical operations window will always contain a criteria field and logical operators:

- **Criteria field** : This is the field where the criteria will be constructed. Click inside the criteria field to reveal the logical operators and supported evaluation types.

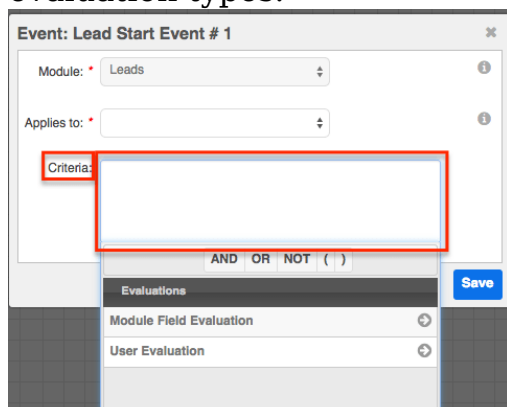

- **Logical Operators** : Click on the AND, OR, and NOT buttons to create logical statements. Use the parentheses to group operations.

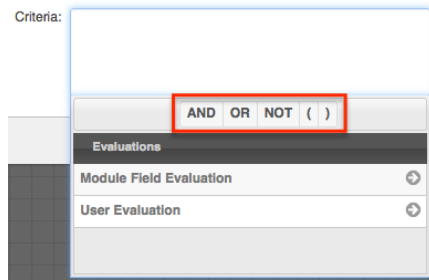

Module Field Evaluation

Note: Module Field Evaluations are logical operations that may be used in Start events and Message events.

To reveal the Module Field Evaluation panel, click inside the criteria field and then click on "Evaluations" and select "Module Field Evaluation":

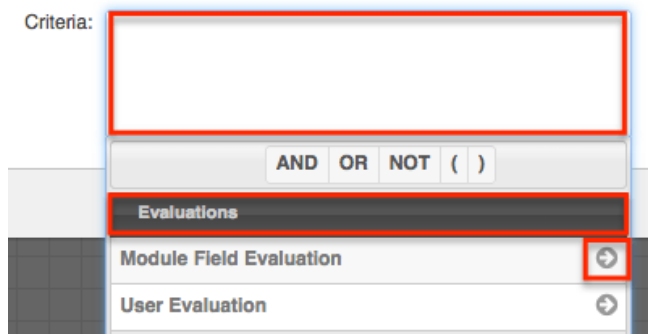

The Module Field Evaluation panel consists of the following options:

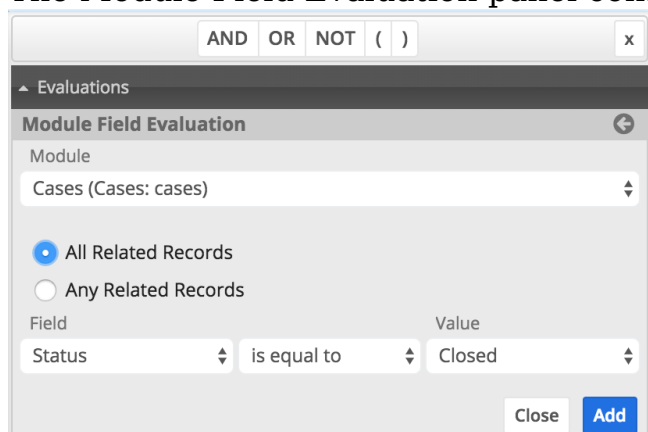

- **Module** : Click the down arrow to list and select the related module whose values will be evaluated.
- **All/Any Related Records** (for related records on the "many" side of a

relationship) : Decide how to evaluate related records when more than one related record may exist.

- Select "All Related Records" if the criteria must be true for all related records.
- Select "Any Related Records" if the criteria require only one or more of the related records to evaluate as true.
- Select "Any Related Records" if you want to use the "changes", "changes to", or "changes from" operator.
- **Note:** Process definitions created before Sugar 8.1 did not have the any/all option and will evaluate only the most recently modified related record. An administrator can update this setting on the Start event's criteria after upgrading to Sugar 8.1 or higher.
- **Field** : Click the down arrow to list and select the field variable of the chosen module.
- **Comparison Operator** (not labeled) : Click the down arrow to list and select a comparative operator. Depending on the field type used in the evaluation, available options may include "is equal to", "contains", "does not contain", "changes", "changes to", and "changes from".
 - For global termination criteria, do not set target record "changes" as a process terminate criteria or it will cause the process to terminate right after starting.
 - **Note:** Comparison operators may not always work as expected for records that were created or edited before the process definition was enabled. To ensure that existing records are evaluated properly for comparators such as "field changes from/to", perform an arbitrary mass update on the target module's records immediately after enabling the process definition so that Sugar can capture the "from" field values.
- **Value** : Enter a value to compare.
- **Add** : Move the evaluation to the criteria field.

Note: Checkbox fields are evaluated as "yes" or "no" (without quotes).

User Evaluation

Note: User Evaluations are logical operations that may be used in Start events, Send Message events, and Gateways.

To reveal the User Evaluation panel, click inside the criteria field and then click on "Evaluations" and select "User Evaluation":

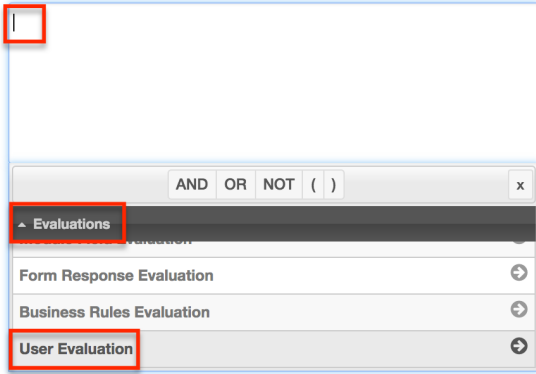

The User Evaluation panel consists of the following options:

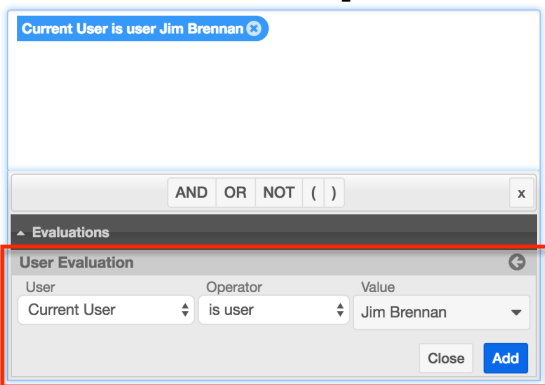

- **User** : Click the down arrow to list and select the type of user related to the current process:



- **Current User** : For a Start event, the Current User refers to the user who is assigned to the target record. For any other element, the Current User refers to the last user who has been defined in the process definition.
- **Supervisor** : applies to the supervisor of the logged-in user who triggers the process
- **Record Owner** : applies to the user who is assigned to the record that triggers the process

- **Operator** : Click the down arrow to select the comparison operator:

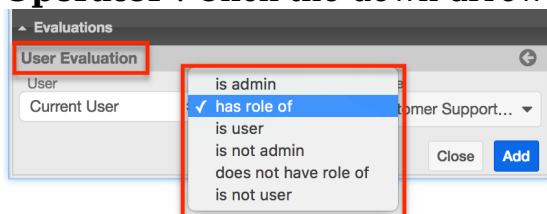

- **is admin** : The condition will only evaluate as true if the user specified in the User field is an admin user. This option will complete the evaluation definition and disable the Value field.
- **has role of** : The condition will only evaluate as true if the user specified in the User field is a member of a certain role. This option will populate the Value field with a list of available user roles.
- **is user** : The condition will only evaluate as true if the user specified in the User field is a specific user. This option will populate the Value field with a list of active users. To select multiple users, add this evaluation once for each user and connect the evaluations with OR operators. Surround all of the user evaluations with parentheses.

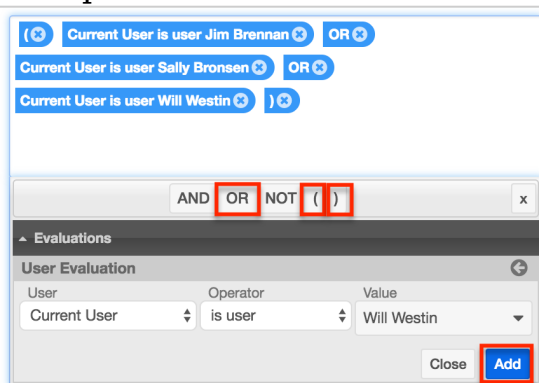

- **is not admin** : The condition will only evaluate as true if the user specified in the User field is not an admin user. This option will complete the evaluation item and disable the Value field.
- **does not have role of** : The condition will only evaluate as true if the user specified in the User field is not a member of a certain role. This option will populate the Value field with a list of available user roles.
- **is not user** : The condition will only evaluate as true if the user specified in the User field is not a specific user. This option will populate the Value field with a list of active users. To select multiple users, add this evaluation once for each user and connect the evaluations with AND operators. Surround all of the user evaluations with parentheses.

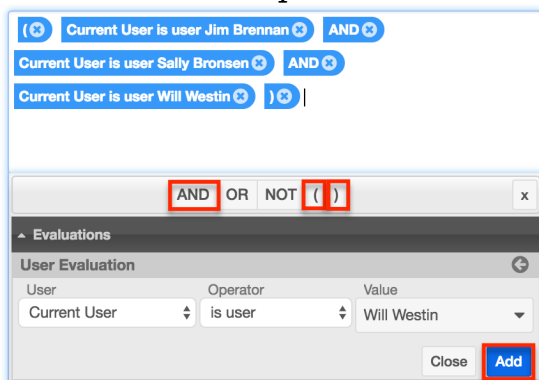

- **Value** : This field will be disabled if the Operator field is set to "is admin"

or "is not admin". If the Operator is set to "is user" or "is not user", the Value field will load the user list as field options. If the Operator is set to "has role of" or "does not have role of", the Value field will load the roles list as field options.

- **Add** : Move the evaluation to the criteria field. By default, the evaluation will be placed at the end of the criteria statement but can be relocated within the statement by dragging it to the desired location.

Follow these steps to add a condition to a Start event:

1. Right-click on the opportunity Start event icon and choose "Settings".

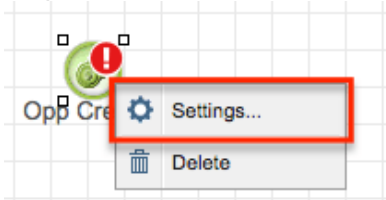

2. Click inside the criteria field and then click on "Evaluations" and select "Module Field Evaluation" to restrict this Process Definition to only certain opportunities.

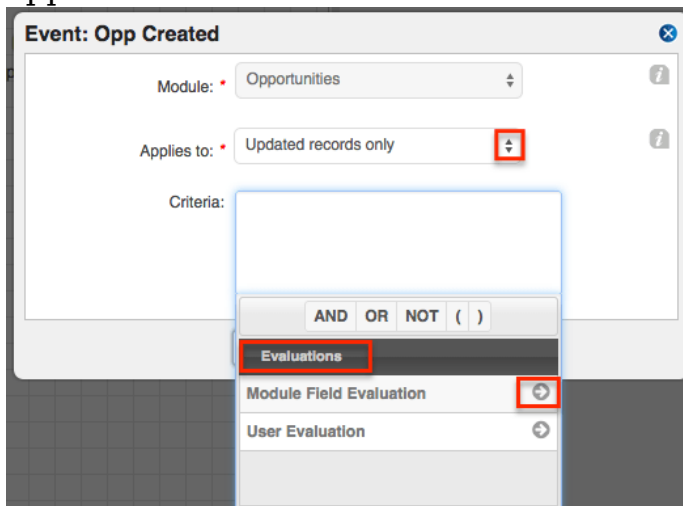

3. Choose a field, operator, and field value for the first condition and then click "Submit" to add the condition to the Criteria window.

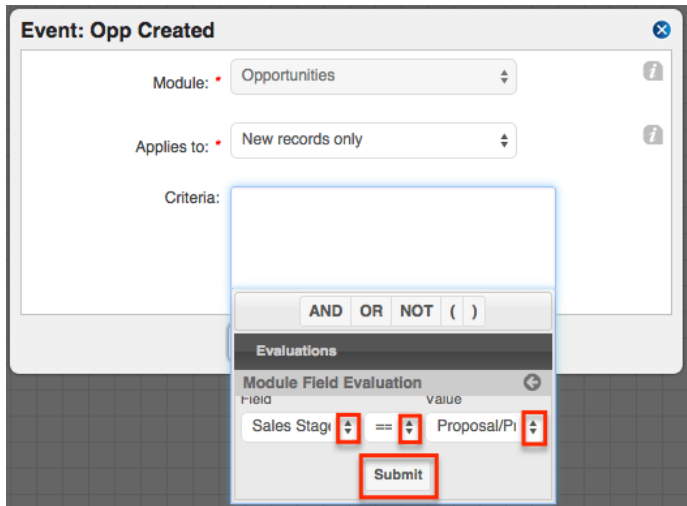

4. Use the boolean logic elements AND, OR, and NOT in conjunction with parentheses for grouped criteria to build a compound filter.

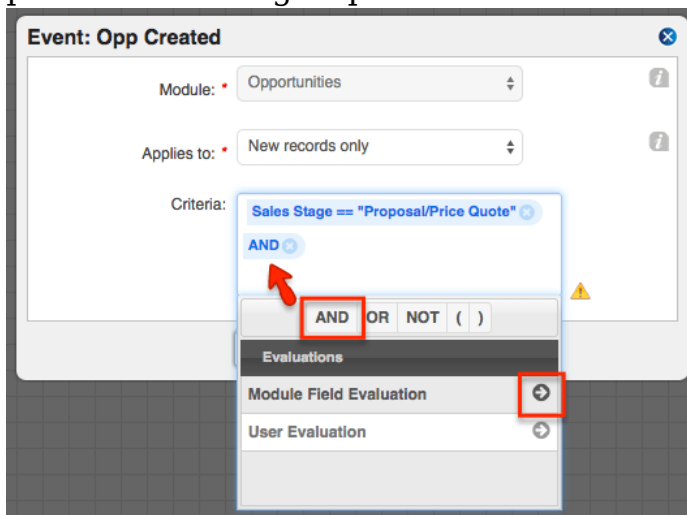

5. Continue adding evaluation filters to the Criteria window.

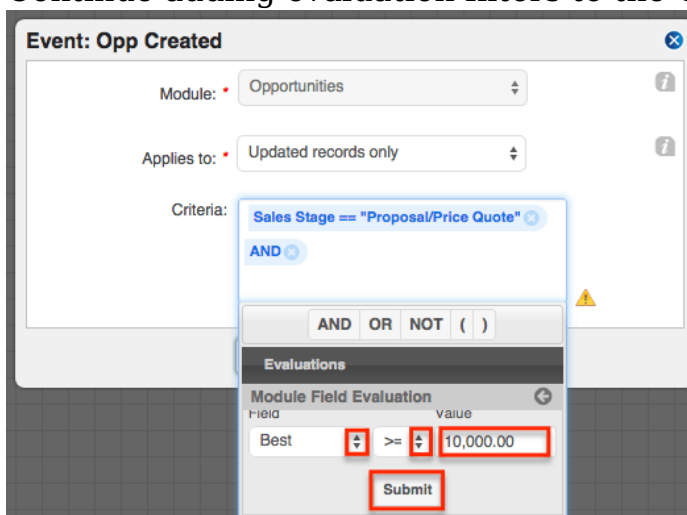

6. When satisfied, click outside of the Criteria field to close the Evaluations window and then click "Save".

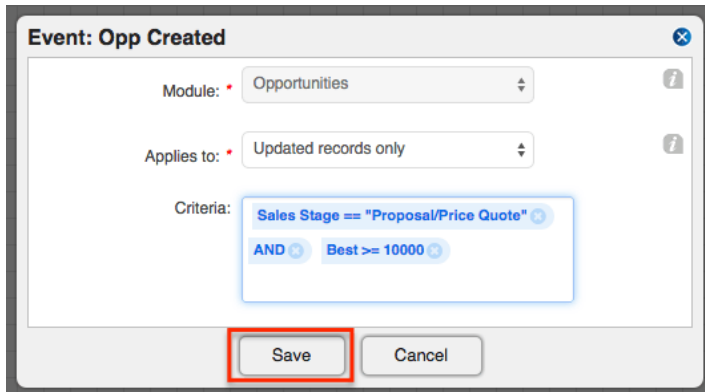

Mathematical Operations

Mathematical operations utilize mathematical operators in conjunction with the Fixed Date, Time Span, and Sugar Date variable options to specify conditions on an event. Mathematical operators can also be used to calculate a numerical value for a Sugar field using a combination of Sugar field variables and constant values. Mathematical operations are defined inside a criteria builder in the process definition's design view.

Note: Mathematical Operations may be used for Wait events, Change Field actions, and Add Related Record actions.

Mathematical operators primarily serve two purposes:

- [Calculating Dates](#) : Use addition (+) and subtraction (-) to create a date that is relative to another date. For example, set a quote as valid until two weeks after its close date:

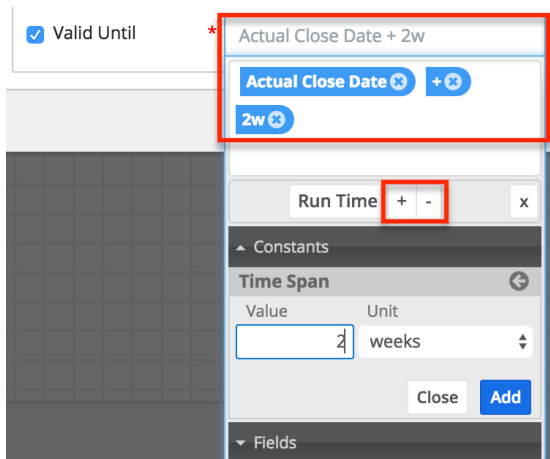

- **Calculating Numeric Values** : Use addition (+), subtraction (-), multiplication (x), and division (/) to create a calculated value relative to another Sugar field. Define a specific order of operations by leveraging parentheses in your formulas. For example, set a discount amount to 10% of the the sum of a record's subtotal plus tax:

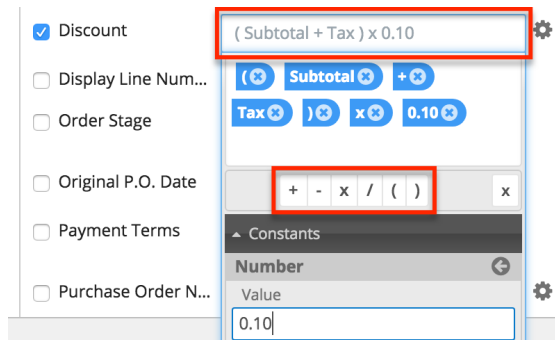

Calculating Dates

Dates are calculated in conditions using one or a combination of [fixed date](#), [time span](#), and [Sugar date field](#) variables. Anything other than the listed configurations or a legal chaining of the supported configurations will be marked as not valid and cannot be saved in a process definition.

The following table lists the supported configurations for date, datetime, and time span calculations in criteria:

Configuration Type	Supported Expressions
Time Span	<ul style="list-style-type: none"> • = date - date • = datetime - datetime • = timespan +/- timespan
Date	<ul style="list-style-type: none"> • = date (e.g. a Fixed Date or Sugar Date Variable)
Datetime	<ul style="list-style-type: none"> • = timespan • = datetime (e.g. a Fixed Date or Sugar Date Variable)

Note: For more information on the Run Time option, which is shown near the plus and minus operators, please refer to the [Sugar Date Variables](#) section.

Fixed Date

The Fixed Date option enables the administrator to specify a formal, static date as a field value or as a variable in a formula that will calculate a field value. For example, if all opportunities in a process are expected to close at the end of the year, create a Change Field action that uses Fixed Date to change all opportunities' Expected Close Date fields to December 31, 2015.

Note: Fixed Dates may be used in mathematical operations for Wait events, Change Field actions, and Add Related Record actions.

To reference a Fixed Date, follow these steps:

1. Click inside the date field and then click on "Constants" and select "Fixed Date":

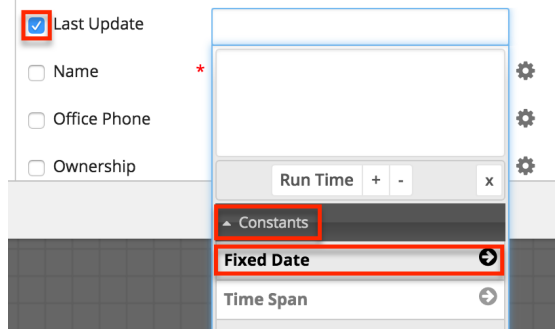

2. The window will transition to a single Date field; click inside the Date field to reveal a calendar picker. Navigate from month to month using the back (<) and forward (>) symbols near the month label. Click on the date that will be used in the formula.

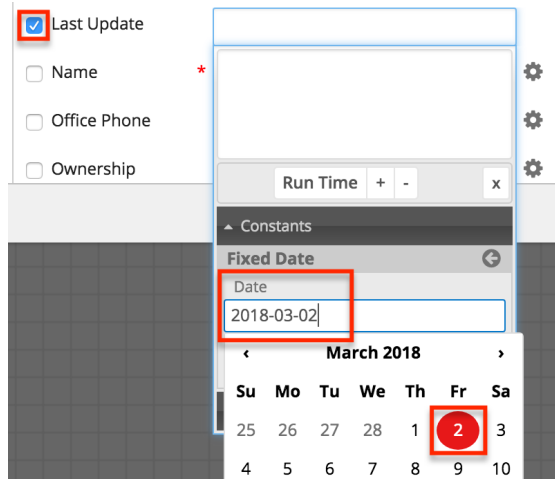

3. Click the Add button to move the selected date onto the criteria builder canvas:

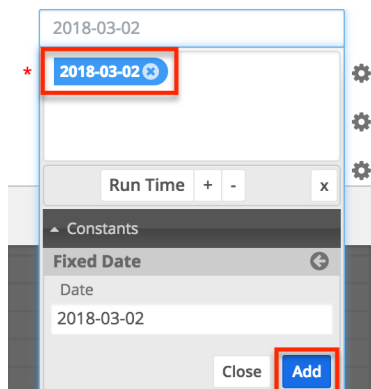

If the date added in this step is the static date for the field value, then the formula is complete. If the Fixed Date is only one component of a larger formula that will be used to determine a field value, then the Fixed Date should be entered in the order it is expected in the formula along with a logical combination of [Time Span](#),

[Sugar Date variables](#), and [mathematical operators](#).

Time Span

The Time Span option allows the passage of time within a date formula. For example, if a Due Date should be set for two weeks after a record's Start Date, build a formula that uses the Time Span "2 weeks" as a variable (e.g., 'Start Date + 2w'). To use a time span element relative to now (e.g., set a due date for 2 weeks from now), then use the Time Span element with a [Run Time variable](#).

Note: Time Spans may be used in mathematical operations for Wait events, Change Field actions, and Add Related Record actions.

To reference a time span, follow these steps:

1. Click inside the date field and then click on "Constants" and select "Time Span":

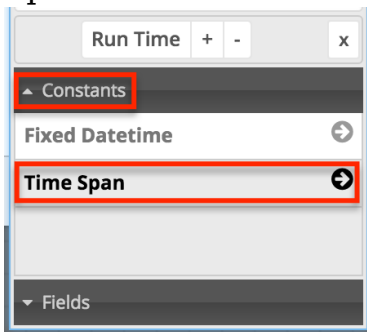

2. The next window will display a Value field and a Units field. Use these two fields together to create a logical time span phrase (e.g., 2 weeks would be set as Value=2; Units=weeks). Time spans can be specified in years, months, weeks, and days for date fields and all of the previous increments plus hours and minutes for datetime fields.

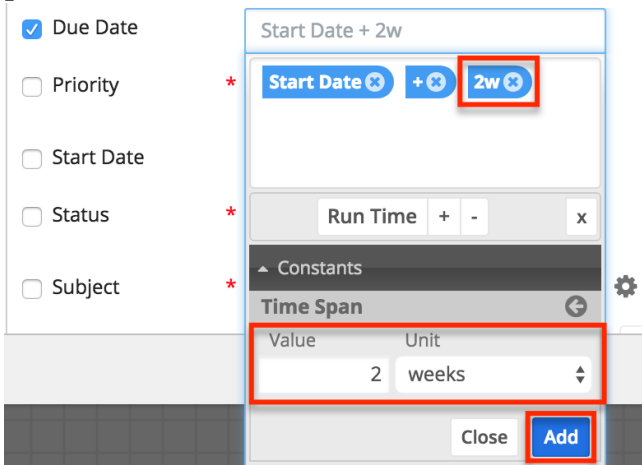

Sugar Serve and Sugar Sell users also have access to the business hours unit for datetime fields on modules related to business centers. This allows you to perform calculations using the open hours of a business center.

When you select "business hours", the Business Center dropdown menu appears where you can search for a specific business center or choose "From Target Module" to use the business center associated with the target module. For more information, refer to the [Business Center Management](#) documentation. For details on user license types, refer to the [License Types](#) documentation.

3. Click the Add button to move the selected time span onto the criteria builder canvas.

Note: The time span element is only one component of a larger formula. Enter it in the order it is expected along with a logical combination of Fixed Date, Sugar Date variables, and/or Mathematical Operators.

Sugar Date Variables

Sugar Date variables include the Run Time variable as well as the date fields from Sugar records. "Run Time" refers to the moment the process element runs. For example, an action that executes at 9:30AM on January 3 has a Run Time value of January 3 for date fields or 9:30AM January 3 for datetime fields. Date field variables can be used to add context to a date formula (e.g., Date Created + 1 month) or referenced independently (e.g., an action or event that triggers on Expected Close Date or three days after run time).

Note: Sugar Date variables may be used in mathematical operations for Wait events, Change Field actions, and Add Related Record actions.

To reference a Sugar date variable, follow these steps:

1. Click inside the date field and the Run Time variable will appear as a button next to the plus and minus operators. To drill down to the date variables for each available module, click on "Fields" then click on the arrow adjacent to the desired module.
2. After clicking on the module name, the window will reveal a list of all available date fields for that module. Click on any date field to move it to the criteria builder window:

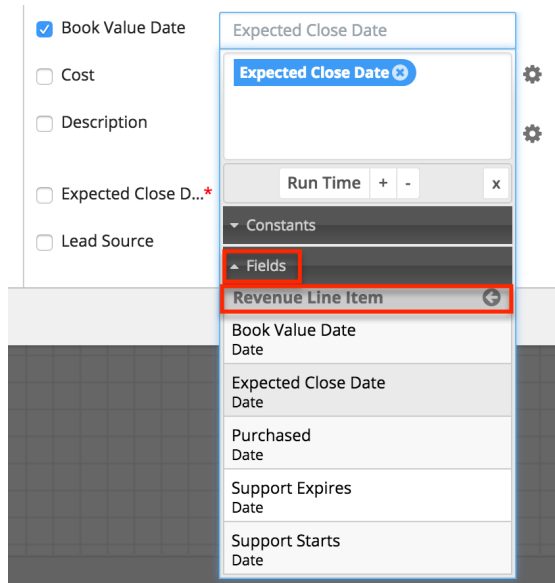

Note: If the date variable is the only component of the date formula, then the formula is complete. If the date variable is only one component of a larger formula that will be used to determine a field value, then the variable should be entered in the order it is expected in the formula along with a logical combination of Time Span, Fixed Dates, and/or Mathematical Operators.

Creating Conditions for Activities and Gateways

Form activities and gateway elements can evaluate user responses to forms or business rules that have been created by the administrator.

The available evaluations are:

- [Form Response Evaluations](#) : Configure this type of criteria for gateways that follow a Form activity.
- [Business Rule Evaluations](#): Configure this type of criteria for gateways that follow a business rule action.

Form Response Evaluations

If a process contains an Approve/Reject activity, it must be followed by a gateway with a form response evaluation. To configure this evaluation, follow these steps:

Note: A divergent Gateway requires two or more subsequent elements (any combination of intermediate events, end events, actions, and/or activities). These must be placed on the canvas and connectors must join the elements on the canvas before the Gateway can be configured.

1. Drag an Activity element onto the design canvas as explained in [Adding Form Activities](#).
2. Drag an Exclusive gateway element onto the design canvas to the right of the Activity.
3. Drag two or more Actions or Events onto the canvas to the right of the Gateway.

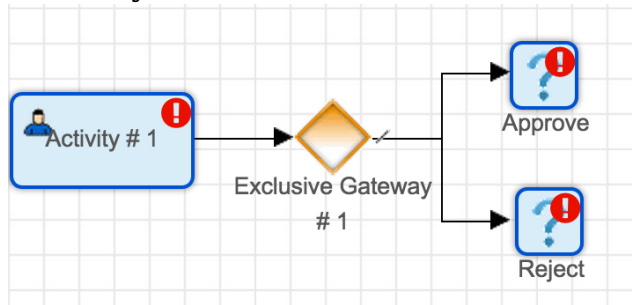

4. Connect the activity to the gateway and the gateway to the subsequent elements using [Sequence Connectors](#).
5. Right-click on the gateway element and specify a [default flow](#). This will be the direction that the flow takes if no criteria are accomplished within the gateway element. For this example, the [default flow](#) is set to the action labeled, "Approve". Please note that the [default flow](#) options will not be available until the corresponding elements have been placed on the canvas and connected to the gateway.

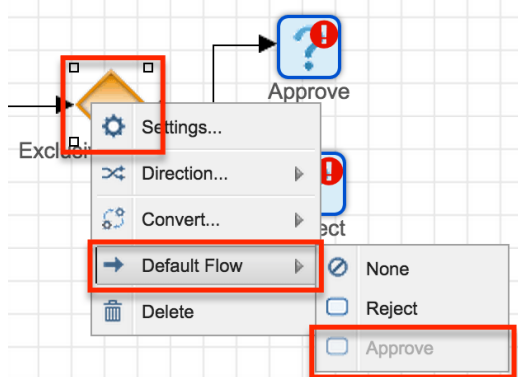

A hash mark will indicate that a [default flow](#) has been successfully configured:

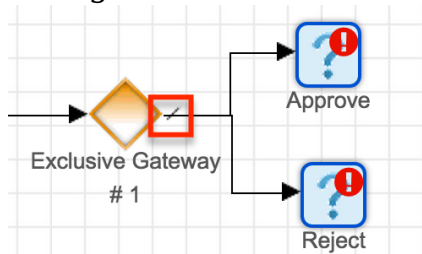

6. Next, right-click on the gateway element again and select "Settings". Note that only the non-default outcome or outcomes will need to be configured. For the current example, we set the [default flow](#) to "Approve" so there is one criteria window, which represents the one non-default element in this example.

- Click inside the Criteria window to reveal evaluation options. The only required evaluation for a Form activity is the "Form Response Evaluation". Click on Evaluations > Form Response Evaluation and then select the form response that will result in the non-default flow. In this example, the form response must be "Rejected" or else the [default flow](#) will take over. Click "Submit" to move the condition to the Criteria window. If multiple criteria are required, click on the AND, OR, NOT, and parentheses operators as needed and insert additional conditional statements.

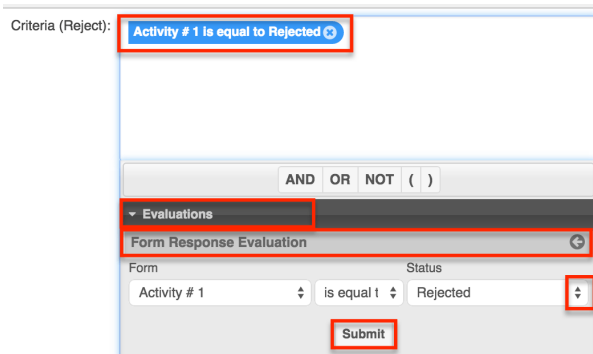

Note: Despite a Form activity having two outcomes (approval and rejection), it is possible to configure additional outcomes using a combination of criteria beyond the form response. For example, a separate outcome may be configured for:

- Form Response = Rejected AND Status = New
 - Form Response = Approved AND Status = New
 - Form Response = Approved AND Status = Closed
 - else [Default Flow](#) : In other words, if none of the above criteria are accomplished, continue with the [default flow](#) element. Please note that the default element does not need to be configured. It will always be the outcome when all other criteria evaluate to false.
- Only one outcome can occur from an Exclusive gateway, and it will be the one that accomplishes the condition. If several criteria are true, the priority will be higher on the one that lies further up the configuration. To change the priority order of a Gateway that is directed toward multiple elements:
 - Right-click on the Gateway element and select the option "Settings".

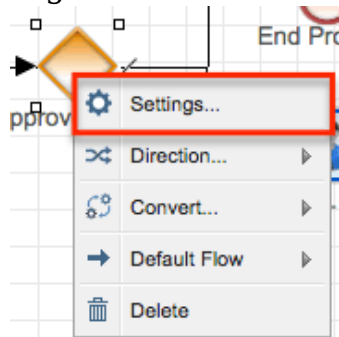

- There will be a criteria builder window for each related element. Place the mouse pointer to the left or right side of the criteria fields and the pointer will change its appearance to a standard "move" cursor type.

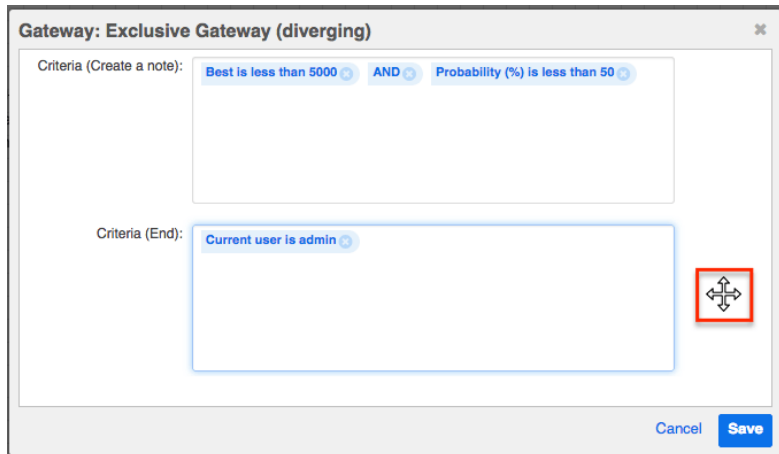

- Drag and drop the criteria fields into the desired sequence. This order will set the priority of the Gateway criteria.

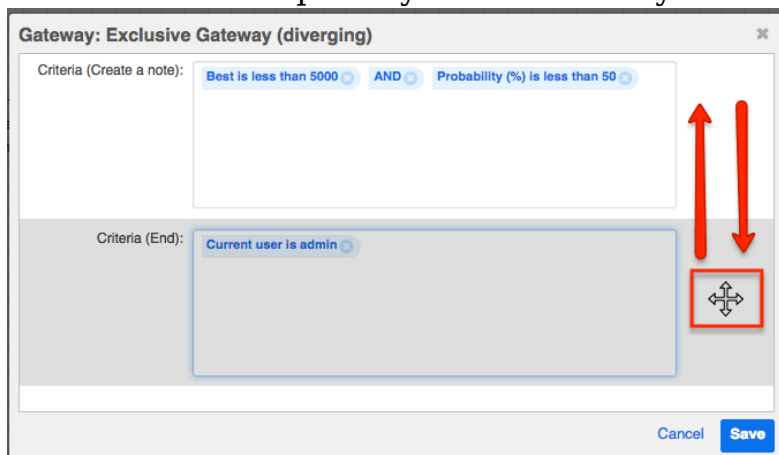

- When you are satisfied with the conditions and their processing order, click "Save" to preserve the changes and return to the visual designer canvas.

Business Rule Evaluations

When referencing a process business rule within a process definition, the action must be followed by a gateway with a business rules evaluation.

Note: A divergent Gateway requires two or more subsequent elements (any combination of intermediate events, end events, actions, and activities). These must be placed on the canvas and connectors must join the elements on the canvas before the Gateway can be configured.

The following steps are an example of incorporating a business rule evaluation in a process definition:

1. Drag an Action element onto the design canvas and configure it as explained in the [Business Rule](#) section of this page.
2. Drag an Exclusive gateway element onto the design canvas to the right of

the Action.

3. Drag two or more action, intermediate, or end events onto the canvas to the right of the diverging gateway.
4. Add a converging exclusive gateway to the right of everything and then connect the Business Rule action to the diverging gateway and connect the diverging gateway to all subsequent elements using [Sequence Connectors](#). Notice that, in the example here, there are three potential outcomes for the gateway: "Assign to Jim", "Assign to Will", or proceed straight to the "Converge" point.

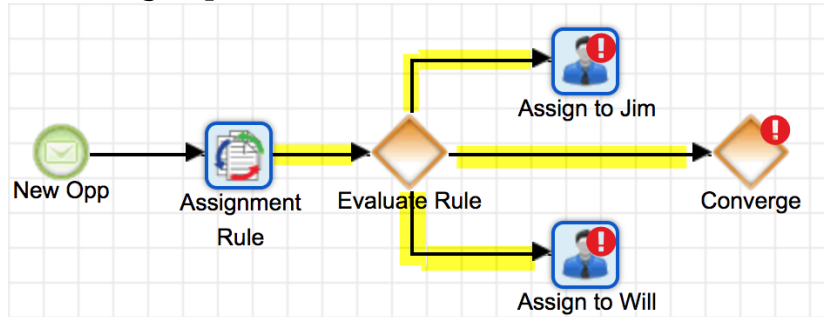

5. Next, confirm that all of the diverging gateway's potential outcomes connect to the converge point using [Sequence Connectors](#).

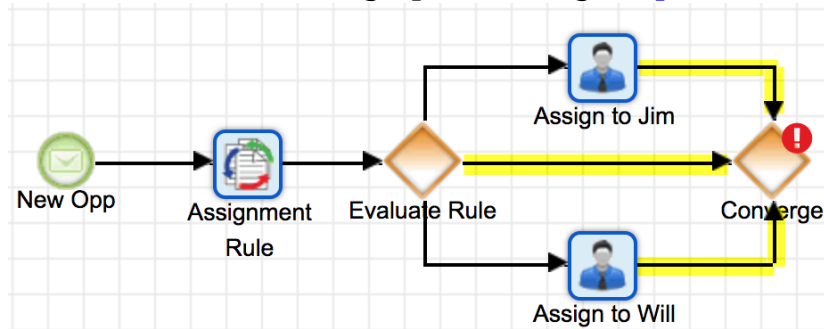

6. Right-click on the gateway element and specify a [default flow](#). This will be the direction that the flow takes if no criteria are accomplished within the gateway element. For this example, the [default flow](#) is set to the action labeled, "Assign to Jim". Please note that the [default flow](#) options will not be available until the corresponding elements have been placed on the canvas and connected to the gateway as explained in the previous steps.

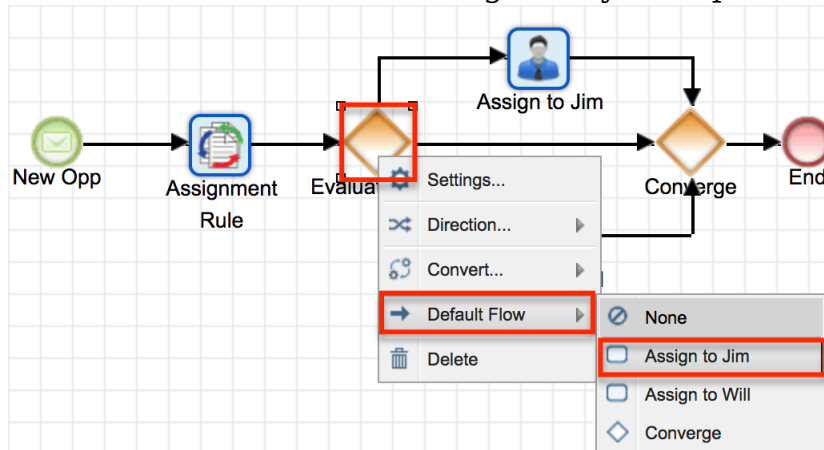

A hash mark will indicate that you have successfully configured the [default flow](#):

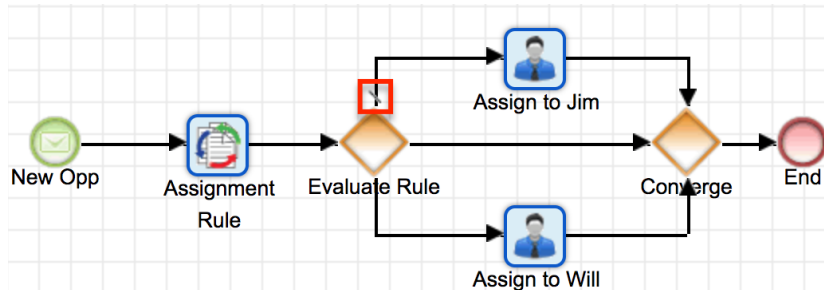

- Next, right-click on the gateway element again and select "Settings". Only the non-default outcome or outcomes will need to be configured. For the current example, we set the [default flow](#) to "Assign to Jim" so there are two criteria windows, which represent the two non-default elements in this example: "Assign to Will" and "Converge".

- Click inside the first Criteria window to reveal the evaluation options. The only required evaluation for a business rule is the "Business Rules Evaluation". Follow the remaining steps to configure the Business Rules Evaluation.
- Click on Evaluations > Business Rules Evaluation. The Business Rule field will appear and display all of the Business Rules that have been referenced by action elements in the current process definition.
- Select the name of the Business Rule action that this gateway is evaluating. In this example, we added an action named "Assignment Rule" in step 1, so we will select that value.
- The Response field will evaluate the Return Value designated in the process business rule. Type the Return Value that, when returned by the business rule, will result in the current process path. For example, if a Return Value of 1 causes the process to end, type "1" (no quotes) into the Response field for the Converge element's Criteria.

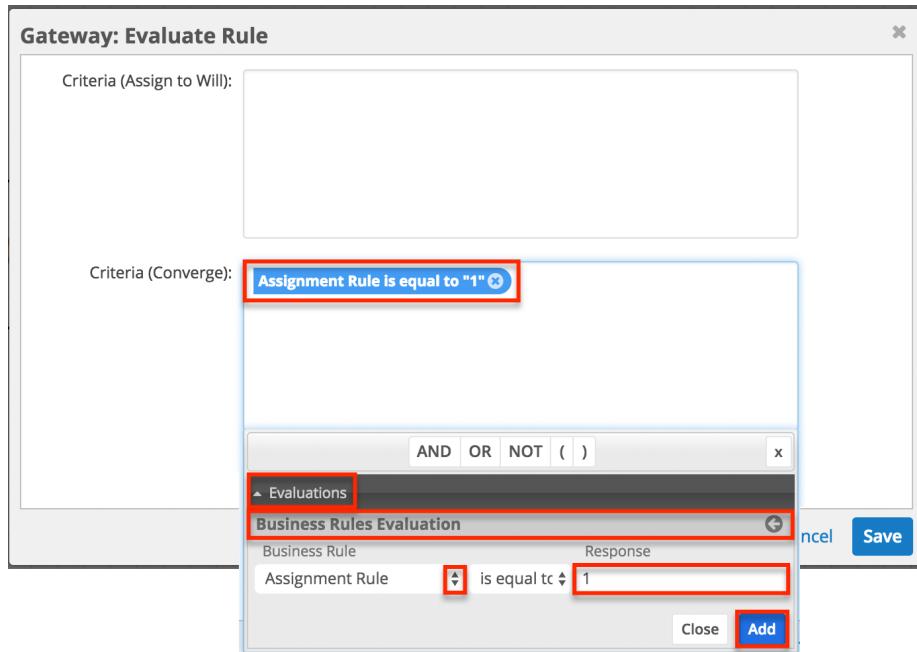

Note: Process business rule "Return Values" will always convert to text for evaluation in the Response field within a process definition.

12. Click "Add" to move the condition to the Criteria window.
13. If multiple criteria are required for a single flow direction, click on the AND, OR, NOT, and parentheses operators as needed and insert additional conditional statements.
14. Continue configuring Criteria for all possible flow outcomes.
15. Only one outcome can occur from an Exclusive gateway, and it will be the one that accomplishes the condition. If several criteria are true, the priority will be higher on the one that lies further up the configuration. To change the priority order of a Gateway that is directed toward multiple elements:
 - Right-click on the Gateway element and select the option "Settings".
 - There will be a criteria builder window for each related element. Place the mouse pointer to the left or right side of the criteria fields and the pointer will change its appearance to a standard "move" cursor type.

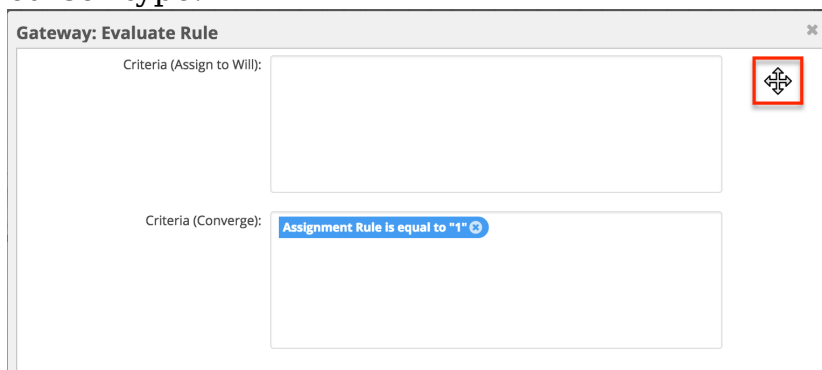

- Drag and drop the criteria fields into the desired sequence. This order will set the priority of the Gateway criteria.

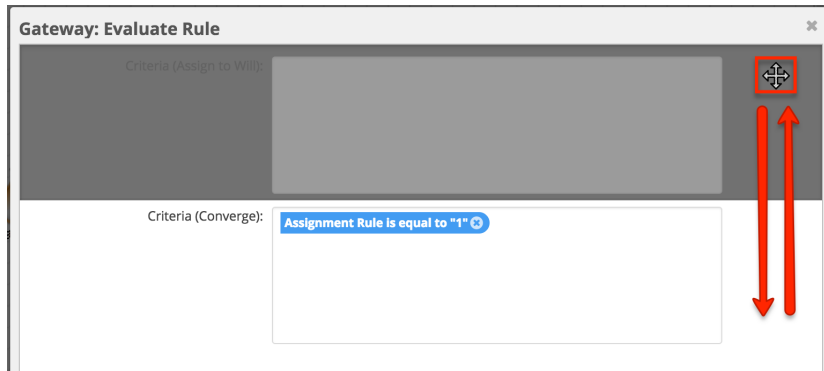

- When you are satisfied with the conditions and their processing order, click "Save" to preserve the changes and return to the visual designer canvas.

Exiting the Visual Designer

At any time during the design of the process definition, you can exit the visual designer by clicking the X at the top of the design canvas. While the visual designer automatically saves your progress by default, you should always press the Save button before exiting the designer in case the last save action occurred before your most recent change or the auto-save has been disabled in Admin > [System Settings](#).

Returning to the Visual Designer

After exiting the Visual Designer, you can return to design view of a process definition from any of the following locations in Sugar:

- From the process definition's record view, select "Design" from the record's Actions menu:

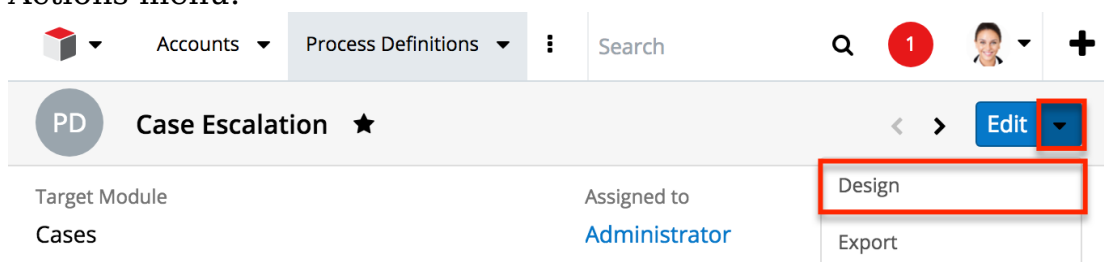

- From the Process Definitions module's list view, select "Design" from the record's Actions menu:

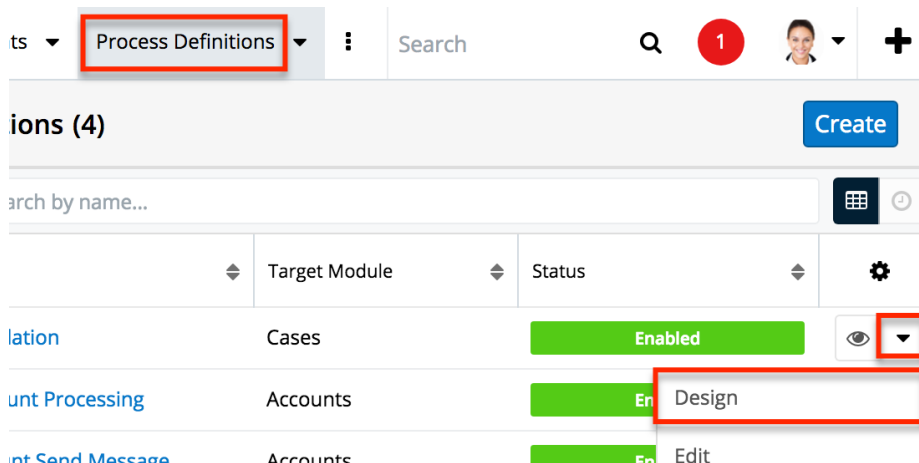

- From the Process Definitions dashlet, click on the Design icon adjacent to the relevant process definition:

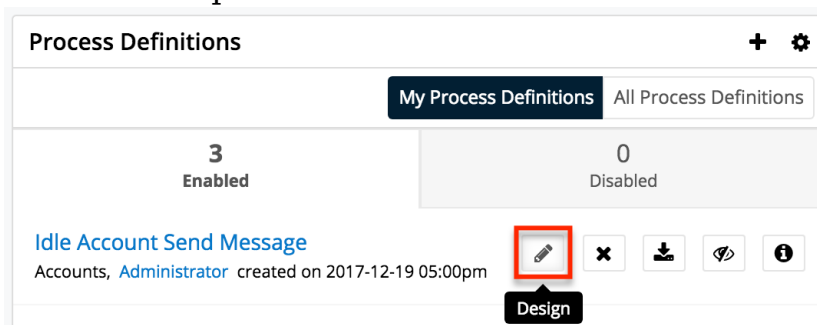

Please note that it may take several seconds for the design canvas to load.

Enabling and Disabling Process Definitions

It is necessary to enable process definitions when their design is complete. It is also possible to disable process definitions when needed. The following sections explain how to enable or disable a process definition.

Enabling Process Definitions

New process definitions are set to "Disabled" by default. This is a preventative feature that ensures a process instance is not triggered inadvertently during the design phase.

Note: Before enabling a process definition, please be sure that you have included a [Terminate Process](#) condition in your process design's settings.

After the design is fully configured, exit the Visual Designer and set the process definition to "Enabled". There are three ways to enable a process definition:

- **Enabling via Dashlet** : Visit your [SugarBPM dashboard](#). Disabled process definitions will be listed in the "Disabled" tab of the Process Definitions dashlet. Find the Enable/Disable icon adjacent to the relevant process definition. Click on the icon and processes will immediately begin running when the process definition's conditions are met.

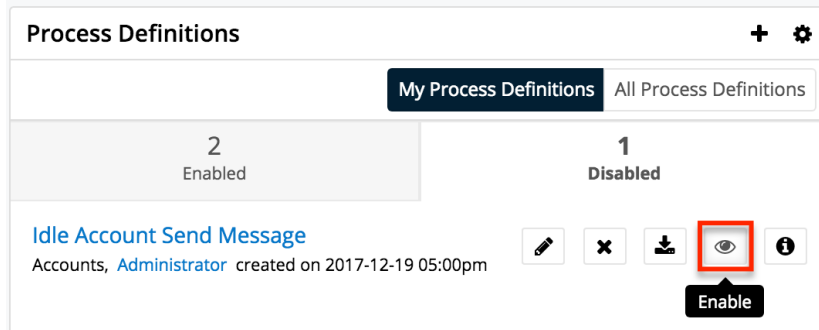

- **Enabling via List View** : Navigate to the Process Definitions list view by clicking on the Process Definitions module tab. From list view, identify the process definition that you want to enable. Click on that row's actions menu and select "Enable" from the dropdown options.

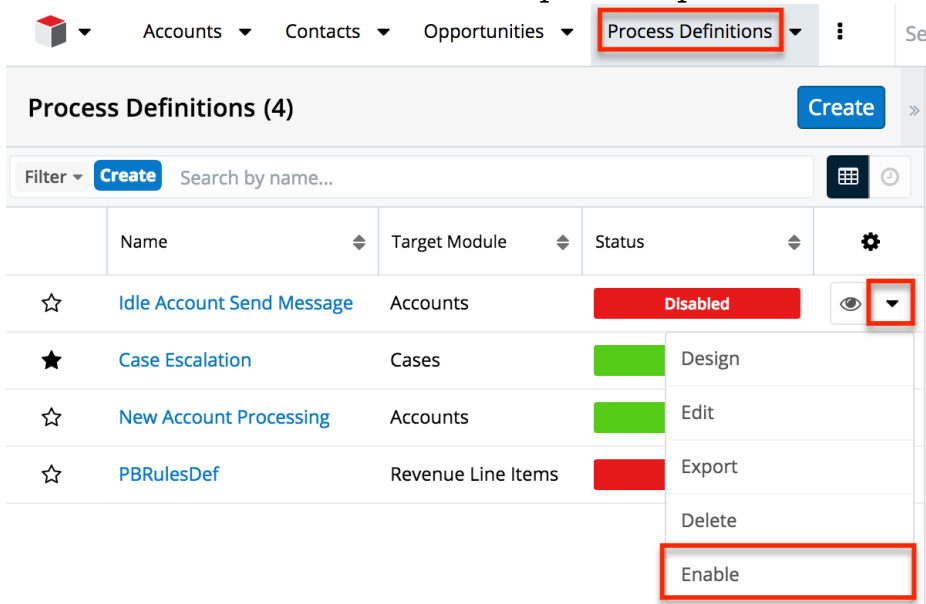

- **Enabling via Record View** : Click the process definition's name in the list view or from the Process Definitions dashlet to navigate to its record view. Edit the record's Status field to "Enabled" and then click the Save button.

PD Idle Account Send Message ☆ Cancel Save »

Target Module: Accounts Assigned to: Administrator

Status: Enabled

The process definition's Status will change from red to green "Enabled". Processes will immediately begin running when the process definition's conditions are met.

Name	Target Module	Status	
☆ Idle Account Send Message	Accounts	Enabled	👁️ ▼

Disabling Process Definitions

Disabling a process definition will prevent it from triggering new processes. Any running processes related to the disabled process definition will pause in an In-Progress state until the process definition is re-enabled. To disable a process definition, use any of the techniques explained in the [Enabling Process Definitions](#) section, choosing "Disabled" instead of "Enabled".

Last Modified: 2020-01-30 21:29:24

Process Business Rules

Overview

The Process Business Rules module is one of four modules that make up Sugar's [SugarBPM™](#) (formerly known as Sugar Process Author), Sugar's business process management tool that enables administrators to streamline common business processes by managing approvals, sales processes, call triaging, and more. The Process Business Rules module is used to create reusable rules that will be referenced by records created in the [Process Definitions](#) module. The rule or set of

rules may enforce business policy, make a decision, or infer new data from existing data.

Before continuing, please read the [SugarBPM](#) overview page, which defines critical vocabulary and other elements that may be referenced in this article.

This documentation contains the following pages:

- [SugarBPM](#)
- [Process Definitions](#)
- Process Business Rules (current page)
- [Process Email Templates](#)
- [Stock SugarBPM Templates](#)

Additionally, the [Processes](#) page of the Application Guide contains documentation for the user-facing elements of SugarBPM. Please note that SugarBPM is not available for Sugar Professional.

The following image illustrates the relationship between all of the SugarBPM modules:

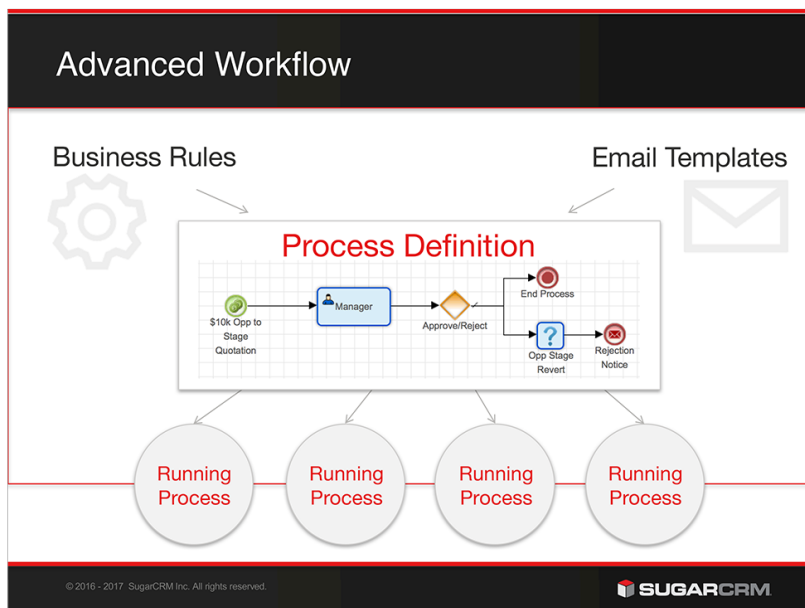

Process Business Rule Fields

The Process Business Rules module contains the following fields. For information on using and editing various field types, refer to the [User Interface](#) documentation.

Field	Description

Assigned To	The Sugar user assigned to the process business rule
Business Rule Type	Specifies how a rule set will be evaluated. This field defaults to "Single Hit", meaning that each row will be evaluated independently in descending order. When a rule in the rule set evaluates as true, the evaluation process stops and that rule's conclusions are executed.
Date Created	The date the process definition record was created
Date Modified	The date the process definition record or its design was last modified
Description	A description or other information about the process definition
Name	A unique and descriptive name
Tags	User-created keywords that can be used to identify records in filters, dashlets, and reports Note: For more information on creating and using tags, please refer to the Tags documentation.
Target Module	The module that will be used for the Start event in the process definition design

Working With Process Business Rules

The following links will open specific sections of the User Interface documentation where you can read about views and actions that are common across most Sidecar modules. The sections following this Working With Process Business Rules section describe business rule-specific behaviors and functionality.

Content Link	Description
Viewing Process Business Rules Viewing via List View Viewing via Record View Viewing via Recently Viewed	The Viewing Records section describes various methods of viewing business rule records, including via the Process Business Rules list view and record view, the Recently Viewed menu in the

	<p>Process Business Rules module tab. For information on viewing the rule(s) defined within the Rules Builder, please refer to the Designing Process Business Rules section of this page.</p>
<p>Searching for Process Business Rules List View Search Creating a Filter Saving a Filter</p>	<p>The Searching for Records section provides an introduction to list view search, which searches and filters within the Process Business Rules module.</p>
<p>Process Business Rules List View Total Record Count Create Button List View Search Favorite Designation Column Reordering Column Resizing Column Sorting Column Selection Preview Record Actions Menu More Process Business Rules Intelligence Pane</p>	<p>The List View section walks through the many elements of the Process Business Rules List View layout which contains a filterable list of all process business rule records in Sugar. While the generic menu options are described in the User Interface sections linked to the left, the options specifically available in the Process Business Rules list view are described in the List View Record Actions Menu section of this page.</p>
<p>Process Business Rules Record View Favorite Designation Next or Previous Record Actions Menu Show More Intelligence Pane</p>	<p>The Record View section walks through the many elements of the Process Business Rules Record View layout which contains detailed information about a single business rule record. While the generic menu options are described in the User Interface sections linked to the left, the options specifically available in the Process Business Rules record view are described in the Record View Actions Menu section of this page.</p>
<p>Editing Process Business Rules Editing Inline via Record View Editing via Record View Editing Inline via List View</p>	<p>The Editing Records section describes the methods of editing existing business rule record fields: inline via the Process Business Rules record view, in full edit mode on the record view, and inline via the Process Business Rules list view. For information on editing the rules defined in the Rules Builder, please refer to the Designing Process Business Rules section of this page.</p>

Deleting Process Business Rules Deleting via Record View Deleting via List View	<p>The Deleting Records section describes two ways to delete business rules: via the Process Business Rules record view and via an individual record's Actions menu on the list view.</p>
Favoriting Process Business Rules Favoriting via List View Favoriting via Record View	<p>The Favoriting Records section describes the various methods of marking business rules as favorites, including via the Process Business Rules list view and Process Business Rules record view. Favoriting a business rule record allows you to easily access it from list views and the Process Business Rules module tab.</p>
Sharing Process Business Rules	<p>The Sharing Records section provides instructions for the Share record view option which composes an email with a link to the process email template record. If the recipient is logged into Sugar, clicking the link will bring them directly to the record view.</p>

Process Business Rules Menus

The following sections describe the various menu options in the Process Business Rules module with links to more information about each option in the User Interface documentation or, for template-specific functionality, within this page.

Module Tab Menu

The Process Business Rules module tab is located on the navigation bar at the top of the Sugar screen when the administrator is engaging with the Process Business Rules module. Click the tab to access the Process Business Rules list view. You may also click the triangle in the Process Business Rules tab to display the Actions, Recently Viewed, and Favorites menus. The Actions menu allows you to perform important actions within the module. The Recently Viewed menu displays the list of business rules you last viewed in the module. The Favorites menu displays the list of business rules you most recently marked as favorites in the module.

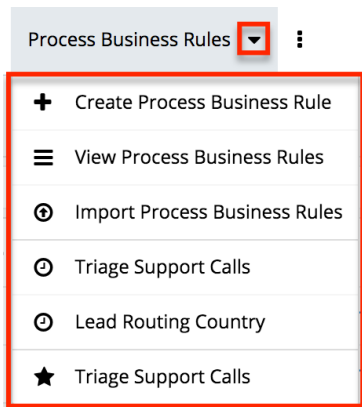

The Actions menu allows you to perform the following operations:

Menu Item	Description
Create Process Business Rule	Opens the record view layout to create a new process rule
View Process Business Rules	Opens the list view layout to search and display process rules
Import Process Business Rules	Opens the import wizard to enable import of .pbr files

If you do not see the Process Business Rules module tab in Sugar, please check the following:

- You must be an administrator user to access the Process Business Rules module or the Process Business Rules module tab.
- The Process Business Rules module may be marked as hidden in your user preferences which will prevent the module tab from being displayed. Navigate to your user profile (upper right of Sugar), click the Advanced tab, and check the Layout Options section. If you see the Process Business Rules module in the Hide Modules list, simply move it to the Display Modules list and save. For more information on hiding and displaying modules, please refer to the Layout Options section of the Getting Started documentation.
- The administrator may have disabled the Process Business Rules module for your entire Sugar instance. Reach out to your Sugar administrator to have the Process Business Rules module displayed. For more information on displaying and hiding modules throughout Sugar, please refer to the Developer Tools documentation in the Administration guide.

List View Record Actions Menu

The Record Actions menu to the far right of each record's row allows you to perform actions on the individual process rule record directly from the list view.

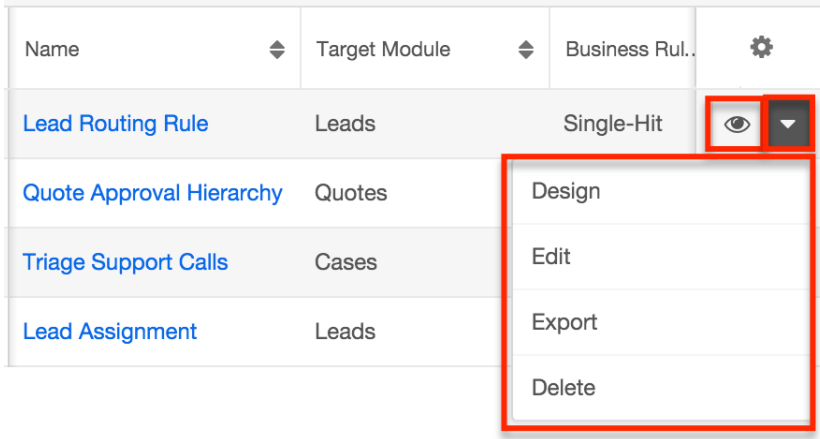

The list view's Record Actions menu allows you to perform the following operations:

Menu Item	Description
Preview	Preview this rule in the intelligence pane
Design	Navigate directly to the Rules Builder view, where you can create and/or edit the condition(s) and conclusion(s) defined by this process business rule
Edit	Edit this process business rule record
Export	Download a copy of this rule to your computer as a .pbr file
Delete	Delete this process business rule

Record View Actions Menu

The business rule's [record view](#) displays the fields relevant to the Process Business Rules module. To access a rule's record view, simply click a hyperlinked business rule name from the Process Business Rules list view. The record view's Actions menu appears on the top right of the page and allows you to perform various operations on the current record.

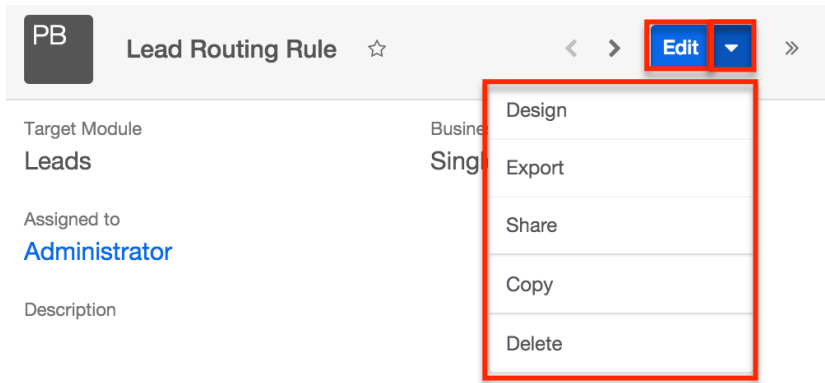

The Actions menu allows you to perform the following operations:

Menu Item	Description
Edit	Edit this process business rule record
Design	Navigate directly to the Rules Builder view, where you can create and/or edit the condition(s) and conclusion(s) defined by this process business rule
Export	Download a copy of this business rule to your computer as a .pbr file
Share	Share a link to this business rule in Sugar via email
Copy	Duplicate this record to make a new process business rule
Delete	Delete this process business rule

Creating Process Business Rules

You should typically create business rules before creating any process definitions that will use the rules. However, it is possible to save an incomplete process definition in order to navigate away and build a rule, then return later to complete the process definition.

Process business rules can be created from any of the following places in Sugar:

- Process Business Rules dashlet:

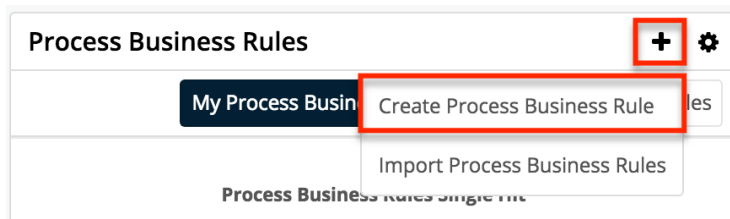

- Process Business Rules module tab menu:

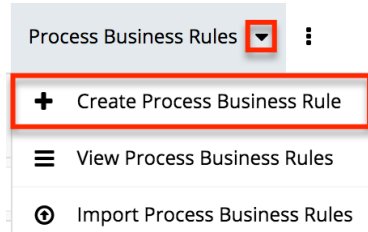

- Process Business Rules list view:

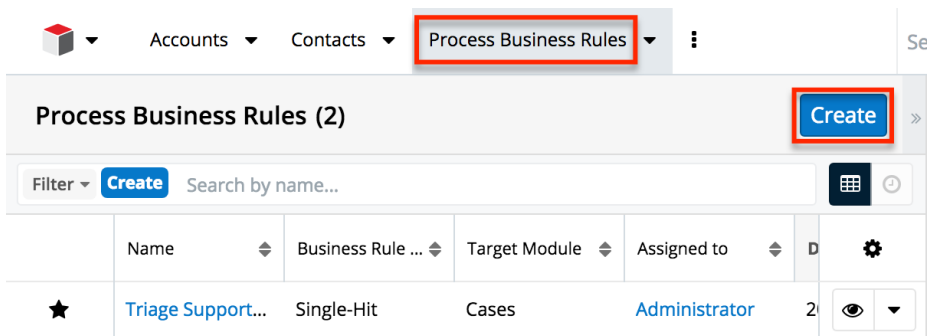

Upon clicking "Create Process Business Rule" (or the Create button from list view), you will be directed to the record view. The record view is where you store information that will make it easy to find and understand the rule in the future. After completing this form, click "Save & Design" to navigate to the [Rules Builder](#) interface where the actual rule criteria and outcomes are defined.

Name:
Cancel **Save & Design**

Target Module:
 Business Rule Type:

Assigned to:

Description:

For more information about the available fields in the Process Business Rules module, please refer to the [Process Business Rule Fields](#) section of this documentation. After configuring and saving the process business rule, it will automatically appear on the administrator's Process Business Rules dashlet and list view, but it will not be ready to use in a process definition until the design step has been completed via the [Rules Builder](#).

Designing Process Business Rules

After saving the process business rule record, use the Rules Builder table to define the conditions and conclusions for the rule(s).

Note: The Rules Builder interface may not be compatible with some touch-screen mobile devices. Please interact with the Rules Builder from a desktop or laptop computer to prevent any potential complications.

The Rules Builder Interface

The screenshot shows the 'Lead Routing Rule *' interface with a target module of 'Leads'. It features a table with two main sections: 'Conditions' and 'Conclusions'. The 'Conditions' section has a header 'Primary Address State' and a sub-header 'is'. The 'Conclusions' section has a header 'Return Value'. The table contains four rows of data. Red annotations highlight various UI elements: a Trash icon for deleting rows, a checkbox for selecting rows, a hand icon for dragging rows, minus and plus icons for deleting or adding columns, and a plus icon for adding a row. A plus icon is also shown at the bottom of the table for adding a new row.

Conditions		Delete/add condition		Conclusions		Add conclusion	
1	<input type="checkbox"/>	Primary Address State	is	"PA"	Return Value	"Central East"	<input type="checkbox"/>
2	<input checked="" type="checkbox"/>		is	"NY"		"Central East"	<input type="checkbox"/>
3	<input type="checkbox"/>		is	"OR"		"Northwest"	<input type="checkbox"/>
4	<input type="checkbox"/>		is	"WA"		"Northwest"	<input type="checkbox"/>
+ Add a row							

Note: The UI elements of the Rules Builder are only displayed if they are relevant to the current view. For example, new rules and rules with only one row will not contain the selection boxes and Trash icon until additional rows have been added.

- Click the plus (+) icon to the right of the Conditions header to add additional condition columns.
- Click the minus (-) icon above a condition column to delete the column.
- Click the plus (+) icon to the right of the Conclusions header to add additional conclusion columns.
- Click the minus (-) icon above a conclusion column to delete the column.
- Click the plus (+) icon at the bottom of the table to add additional rows and create a rule set.
- Select the checkbox next to one or more rows and then click the Trash icon to delete the selected row(s).
- Select the checkbox next to one or more rows and then click on one of the selected rows' numbers to drag and drop them to a new position.

The following steps describe how to interact with the Rules Builder.

1. For each column in the Conditions section, select a field variable (e.g. Lead

Source) from the dropdown inside the white header cell.

Lead Routing Rule | Target Module: Leads



2. Beneath the header, click inside the first row and select the operator needed to evaluate the variable selected in step 1. To change the operator, click on the cell to view and select the available operators in the list.

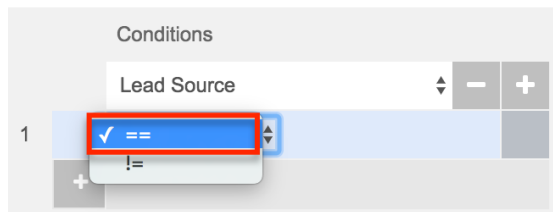

3. Next to the operator, select the field value for the condition. Click on the empty area of the cell to select a field value or access the criteria builder where you can define constants, fields, etc. For more information on using the criteria builder, please refer to the [Process Definitions](#) documentation.

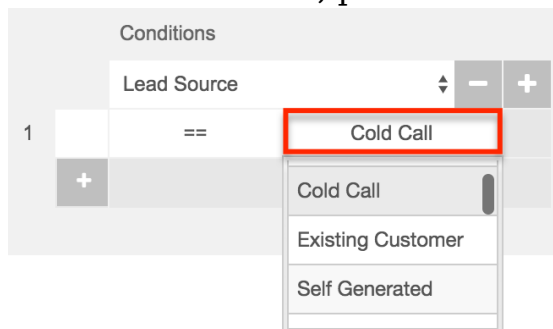

4. Optionally, add more Condition columns to satisfy your use case. All conditions defined within the same row must be met in order to trigger the associated conclusion. In addition, when any one row has satisfied all of its conditions, its conclusion will be triggered and no subsequent rows will be evaluated.
5. For the Conclusions block, click in the empty row beneath the Return Value header.

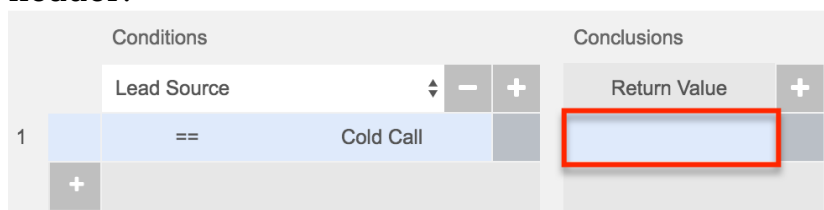

6. In the criteria builder, define the return value for when the row's condition evaluates as true. A process definition's Gateway will evaluate the returned values and react accordingly. A Return Value is required for each row.

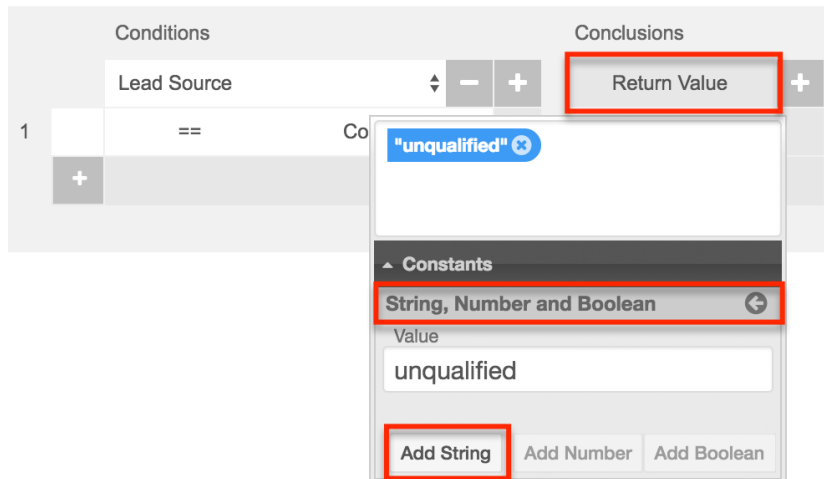

7. Optionally, add more Conclusion columns to update a field value (e.g. "Assigned to") when the row's condition evaluates as true.
8. Continue adding conditional rows as needed until your rule set is complete. For more information, please refer to the [Creating Rule Sets](#) section.

Creating Rule Sets

A single process business rule record could potentially define a set of several rules, or a rule set. In the following example of a set of rules for routing leads, each row of the Rules Builder table represents a separate rule that will be evaluated by the process. Each row is evaluated independently in descending order. When a rule in the rule set is evaluated as true, the evaluation process stops. Therefore, only the conclusions defined by the first (topmost) true condition will be returned.

The following example represents a rule set that evaluates two fields, "Lead Source" and "Status", to determine a return value, assigned user, and a possible value for "Do Not Call". The first row translates conversationally to: If the lead has a new status and its source is a Cold Call, then capture the office phone number, assign the lead to Jim Brennan, and make no changes to the Do Not Call field.

Lead Routing Rule | Target Module: Leads

Conditions				Conclusions			
	Lead Source		Status	Return Value	Assigned to	Do Not Call	
1	==	Cold Call	==	New	Office Phone	Jim Brennan	
2	==	Public Relations	==	New	Office Phone	Sally Bronsen	
3	==	Email	==	New	Email Address	Chris Olliver	
4	!=	Existing Customer	==	New	"NA"	Administrator	true

Condition and Conclusion Elements

Process business rules comprise at least one condition:conclusion element.

- **Conditions** : One or more "if" statements that will be evaluated as true or false.
- **Conclusions** : The results that are returned if the condition evaluates to true.

By default, a true condition must result in a Return value. The Return value can be constructed using variables, constants, operators and/or literal values. If there are to be multiple outcomes to the condition, the Return value must be specified as the first conclusion in the business rule. For example, to change the value of a given field when the condition is true, set an arbitrary return value and then click on the + button adjacent to the table header "Conclusions" to add another conclusion column to the row where the field update can be defined.

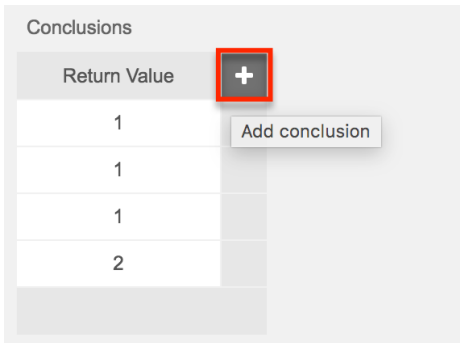

The condition will evaluate a set of given variables and if the condition is evaluated as "true", the conclusion will then return a specified value.

Note: Process business rule Return values will always convert to text for evaluation within a process definition.

Operator Elements

Conditions utilize comparison operators. Multiple conditions in a single row will be combined using AND logic, requiring all conditions in a row to be satisfied in order for the statement to be evaluated as true. The available operators are:

Operator	Definition	Available for Field Types
==	is equal to	integer, currency, date, dropdown, multiselect
!=	is not equal to	integer, currency, date, dropdown, multiselect
>=	is greater than or equal to	integer, currency, date
<=	is less than or equal to	integer, currency, date

>	is greater than	integer, currency, date
<	is less than	integer, currency, date
is	exactly matches	text, email
is not	does not exactly match	text, email
starts with	first characters of the field match	text, email
ends with	last characters of the field match	text, email
contains	the characters are found in sequence anywhere in the field	text, email
does not contain	the characters are not found in sequence anywhere in the field	text, email

Note: If using a currency field in a business rule, values should have no currency symbol (such as \$) and no thousands separator. Only the period (.) is allowed as a decimal separator.

For information about utilizing process business rules in process definitions, refer to the [Actions > Business Rule](#) section of the Process Definitions documentation.

Last Modified: 2020-01-24 21:06:50

Process Email Templates

Overview

The Process Email Templates module is one of four modules that make up [SugarBPM™](#), Sugar's business process management tool that enables administrators to streamline common business processes by managing approvals, sales processes, call triaging, and more. A process email template is required in order to include a Send Message event in a [process definition](#). Sugar's core product includes several places where email templates can be created for different purposes, but SugarBPM requires all sent messages to be created via the Process Email Templates module.

Before continuing, please read the [SugarBPM](#) overview page, which defines

critical vocabulary and other elements that may be referenced in this article.

The SugarBPM documentation contains the following pages:

- [SugarBPM](#) (overview)
- [Process Definitions](#)
- [Process Business Rules](#)
- Process Email Templates (current page)
- [Stock SugarBPM Templates](#)

Additionally, the [Processes](#) page of the Application Guide contains documentation for the user-facing elements of SugarBPM. Please note that SugarBPM is not available for Sugar Professional.

The following image illustrates the relationship between the four SugarBPM modules:

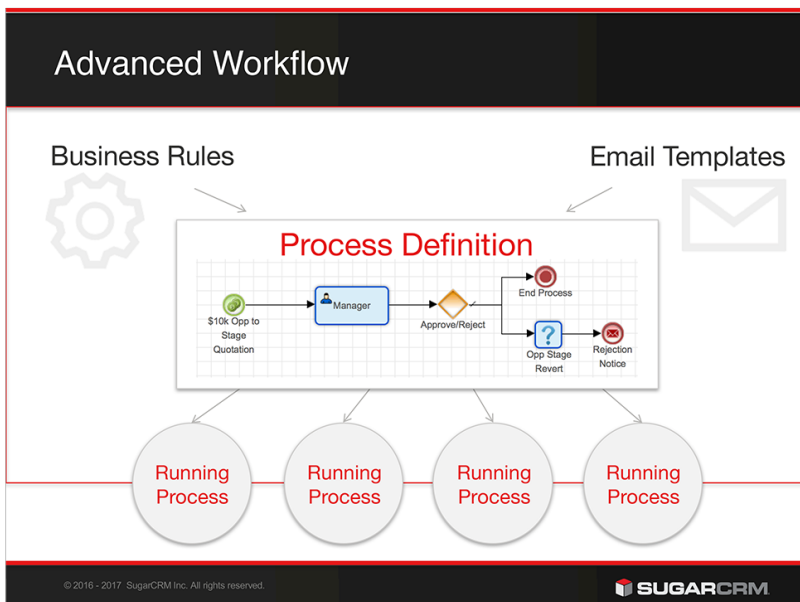

Process Email Template Fields

The Process Email Templates module contains the following fields. For information on using and editing various field types, refer to the [User Interface](#) documentation.

Field	Description
Assigned To	The Sugar user assigned to the process email template
Date Created	The date the process email template

	record was created
Date Modified	The date the process email template record or its content was last modified
Description	A description or other information about the process email template
Name	A unique and descriptive name
Tags	User-created keywords that can be used to identify records in filters, dashlets, and reports Note: For more information on creating and using tags, please refer to the Tags documentation.
Target Module	The module against which the template's processes will be defined

Working With Process Email Templates

The following links will open specific sections of the User Interface documentation where you can read about views and actions that are common across most Sidecar modules. The sections following this Working With Process Email Templates section describe Process Email Template-specific behaviors and functionality.

Content Link	Description
Viewing Process Email Templates Viewing via List View Viewing via Record View Viewing via Recently Viewed	<p>The Viewing Records section describes various methods of viewing process email template records, including via the Process Email Templates list view and record view and the Recently Viewed menu in the Process Email Templates module tab.</p> <p>For information on viewing the content of a template's message, please refer to the Designing Process Email Templates section below.</p>
Searching for Process Email Templates List View Search Creating a Filter Saving a Filter	<p>The Searching for Records section provides an introduction to list view search, which searches and filters within the Process Email Templates module.</p>

<p>Process Email Templates List View Total Record Count Create Button List View Search Favorite Designation Column Reordering Column Resizing Column Sorting Column Selection Preview Record Actions Menu More Process Email Templates Intelligence Pane</p>	<p>The List View section walks through the many elements of the Process Email Templates List View layout which contains a filterable list of all process email template records in Sugar. While the generic menu options are described in the User Interface sections linked to the left, the options specifically available in the Process Email Templates list view are described in the List View Record Actions Menu section of this page.</p>
<p>Process Email Templates Record View Favorite Designation Next or Previous Record Actions Menu Show More Intelligence Pane</p>	<p>The Record View section walks through the many elements of the Process Email Templates Record View layout, which contains detailed information about a single process email template record. While the generic menu options are described in the User Interface sections linked to the left, the options specifically available in the Process Email Templates record view are described in the Record View Actions Menu section of this page.</p>
<p>Editing Process Email Templates Editing Inline via Record View Editing via Record View Editing Inline via List View</p>	<p>The Editing Records section describes the methods of editing existing process email template record fields: inline via the Process Email Templates record view, in full edit mode on the record view, and inline via the Process Email Templates list view.</p> <p>For information on editing the content of a template's message, please refer to the Designing Process Email Templates section below.</p>
<p>Deleting Process Email Templates Deleting via Record View Deleting via List View</p>	<p>The Deleting Records section describes two ways to delete process email templates: via the Process Email Templates record view and via an individual record's Actions menu on the list view.</p>
<p>Favoriting Process Email Templates</p>	<p>The Favoriting Records section</p>

Favoriting via List View Favoriting via Record View	describes the various methods of marking process email templates as favorites, including via the Process Email Templates list view and Process Email Templates record view. Favoriting a process email template record allows you to easily access it from list views and the Process Email Templates module tab.
Sharing Process Email Templates	The Sharing Records section provides instructions for the Share option in record view, which composes an email with a link to the process email template record. If the recipient is logged into Sugar, clicking the link will bring them directly to the record view.

Process Email Template Menus

The following sections describe the various menu options in the Process Email Templates module with links to more information about each option in the User Interface documentation or, for template-specific functionality, within this page.

Module Tab Menus

The Process Email Templates module tab is located on the navigation bar at the top of the Sugar screen when the administrator is engaging with the Process Email Templates module. Click the tab to access the Process Email Templates list view. You may also click the triangle in the Process Email Templates tab to display the Actions, Recently Viewed, and Favorites menus. The Actions menu allows you to perform important actions within the module. The Recently Viewed menu displays the list of templates you last viewed in the module. The Favorites menu displays the list of templates you most recently marked as favorites in the module.

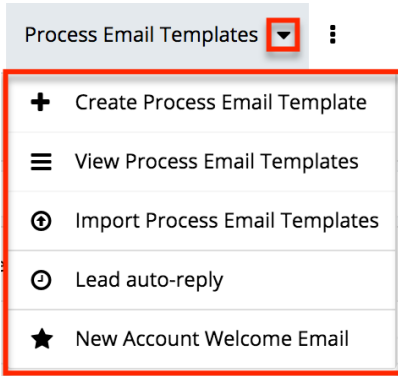

The Actions menu allows you to perform the following operations:

Menu Item	Description
Create Process Email Template	Opens the record view layout to create a new email template
View Process Email Templates	Opens the list view layout to search and display email templates
Import Process Email Templates	Opens the import wizard to enable import of .pet files

If you do not see the Process Email Templates module tab in Sugar, please check the following:

- You must be an administrator user to access the Process Email Templates module or the Process Email Templates module tab.
- The Process Email Templates module may be marked as hidden in your user preferences which will prevent the module tab from being displayed. Navigate to your user profile (upper right of Sugar), click the Advanced tab, and check the Layout Options section. If you see the Process Email Templates module in the Hide Modules list, simply move it to the Display Modules list and save. For more information on hiding and displaying modules, please refer to the Layout Options section of the Getting Started documentation.
- The administrator may have disabled the Process Email Templates module for your entire Sugar instance. Reach out to your Sugar administrator to have the Process Email Templates module displayed. For more information on displaying and hiding modules throughout Sugar, please refer to the Developer Tools documentation in the Administration guide.

List View Record Actions Menu

The Record Actions menu to the far right of each record's row allows you to

perform actions on the individual process email template record directly from the list view.

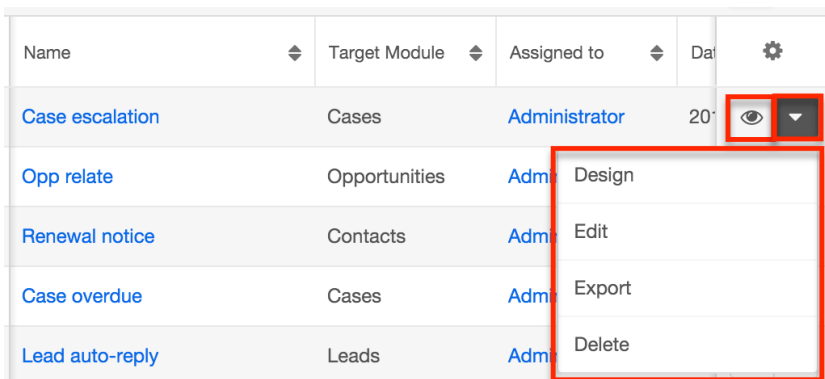

The list view's Record Actions menu allows you to perform the following operations:

Menu Item	Description
Preview	Preview this email template in the intelligence pane
Design	Navigate directly to the template's design view, where you can create and edit the message's content
Edit	Edit this process email template
Export	Download a copy of this template to your computer as a .pet file
Delete	Delete this process email template

Record View Actions Menu

The template's [record view](#) displays the fields relevant to the Process Email Templates module. To access a template's record view, simply click a hyperlinked template name from the Process Email Templates list view. The record view's Actions menu appears on the top right of the page and allows you to perform various operations on the current record.

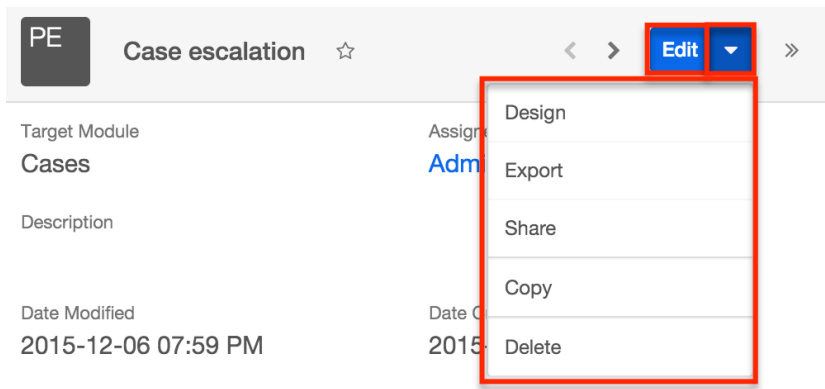

The Actions menu allows you to perform the following operations:

Menu Item	Description
Edit	Edit this process email template
Design	Navigate directly to the template's design view, where you can create and edit the message's content
Export	Download a copy of this template to your computer as a .pet file
Share	Share a link to this template in Sugar via email
Copy	Duplicate this record to make a new process email template
Delete	Delete this process email template

Creating Process Email Templates

You should typically create email templates before creating any process definitions that will use the templates. However, it is possible to save an incomplete process definition in order to navigate away and build an email template, then return later to complete the process definition.

Process email templates can be created from any of the following places in Sugar:

- Process Email Templates dashlet:

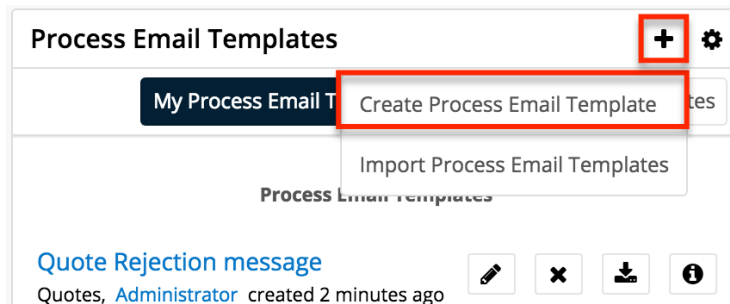

- Process Email Templates module tab menu:

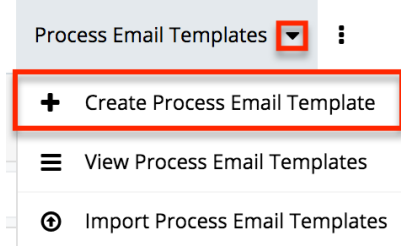

- Process Email Templates list view:

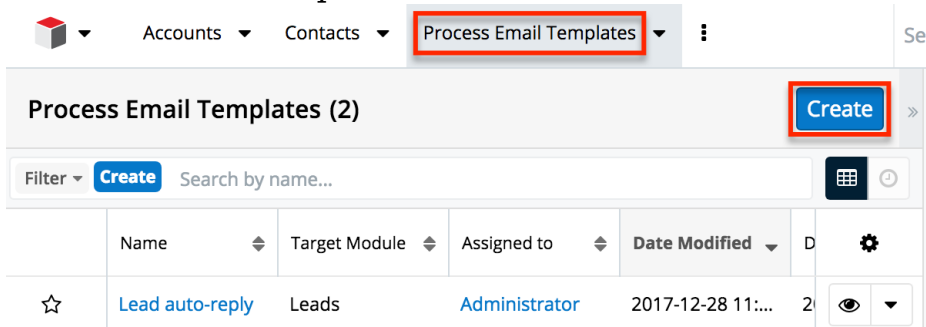

Upon clicking "Create Process Email Template" (or the Create button from list view), you will be directed to the record view. The record view is where Sugar stores information that will make it easy to find and understand the purpose of the email template in the future. After completing this form, you will be directed to the [design view](#) to create the actual content of the message.

After configuring and saving the process email template, it will automatically appear on the administrator's Process Email Templates dashlet and list view, but it will not be ready to use in a process definition until the design step has been completed via the [design view](#).

Designing Process Email Templates

After submitting the template's record view, you must create the custom layout and design of the message that will be sent by related process definitions. Click "Save & Design" in record view to automatically enter the Process Email Template's design view. The field values for Target Module, Name, and Description are automatically pre-populated on this screen based on the values entered on the record view.

Process Email Templates Cancel Save

Target Module: Quotes

Name: Quote Rejection Message

Description: Email template for processes that notify user of a rejected quote.

Subject: Required

Rich text editor toolbar: <> B I U S List Bulleted List Numbered List Indent Decrease Indent Increase Text Color Background Color

SugarBPM's email template design interface is an easy-to-use WYSIWYG editor. The two elements available in the design view that cannot be accessed from record view are the design toolbar and the message body. The following sections cover how to use these elements to craft an email message template.

Rich text editor toolbar: <> B I U S List Bulleted List Numbered List Indent Decrease Indent Increase Text Color Background Color

Font Sizes Paragraph Link Settings Undo

This is the message body, just under the design toolbar.

At any time during the design of a template, you may click the Save button to preserve your work. After completing the content of the message, expand the record's Actions Menu to reveal "Save & Exit". Click on this menu item to return to the Process Email Templates list view and continue working in Sugar.

Process Email Templates | Quote Rejection Message Cancel Save >>



Target Module: Quotes



Name: Quote Rejection Message

Save & Exit

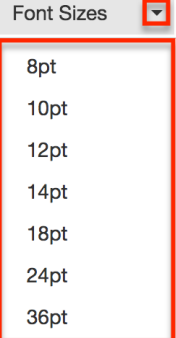
The Design Toolbar

The toolbar is powered by the TinyMCE rich-text editor framework and presents familiar formatting options:

Element	Button(s)	Function
Edit HTML Source	<>	Bypass the rich-text editor options and insert your own HTML code, or view the HTML code of an existing template to make advanced changes.
Bold; Italic; Underline; Strikethrough	B <i>I</i> <u>U</u> S	Use these basic font formatting options to easily add common styles to text in the message body.
Insert/Remove Bulleted List; Insert/Remove Numbered List	☰ ☰☰	Transform paragraphs in the message body into a formatted list.
Align Left; Align Center; Align Right; Justified	☰ ☰☰ ☰☰☰ ☰☰☰☰	Set paragraph alignment.
Text Color; Background Color		Choose a custom font color or highlight text with a background font color.
Font Size		Make text larger or smaller.
Fields Selector		Look up and insert Sugar module field variables. For more information, see the Fields Selector section below.

Record Link Selector		Look up and insert a hyperlink to a Sugar record related to the process's target record. For more information, see the Record Link Selector section below.
Insert/Edit Link		Insert or edit a link to a web page, hosted file, or other location on the web.

Using the Fields Selector Tool

Process email templates can be customized using data pulled directly from your Sugar database. For example, an email template triggered by the Cases module could contain critical case details such as the support agent's name or the phone number of the contact related to the case. Related-module fields can be referenced from modules that have a one-to-one or one-to-many relationship with the target module. If a field has been updated, both its old and current values can be included.

Note: Before using old values in your message's template, be sure to refer to the [Understanding Current and Old Values](#) section for important usage information regarding your process definition's design.

Common use cases for the Fields Selector tool include using the recipient's name and mentioning the old and new values of a changed field such as "Status" in the message body. To insert custom values using the Fields Selector tool, follow these steps:

1. From the process email template's design view, place the cursor in the message body where the custom name variable should appear. Click on the Fields Selector icon in the design toolbar.

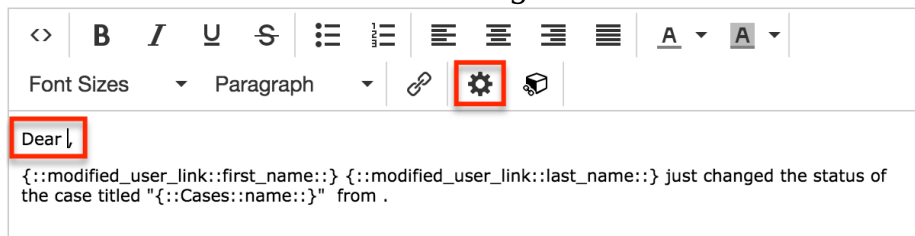

2. The Fields Selector drawer will open over the current screen. By default, it displays all fields in the template's target module. To find a variable from a related module, click the word "Module" to the left of the search bar and select the desired module.

Fields Selector Cancel Done >>

Module **Target Module** Search...

Target Module	Module
Accounts [*:1] (Account: accounts)	Cases
Users [*:1] (Assigned to User: assigned_user_link)	Cases
Users [*:1] (Created User: created_by_link)	Cases
Users [*:1] (Modified User: modified_user_link)	Cases
None Status	Cases
None Source	Cases

- The list of field variables will update automatically. Open the dropdown adjacent to the field or fields that you would like to insert and choose "Current Value". In this example, we are choosing to add the current value of the recipient's first and last name. Click "Done" to insert the field variables into the email template.

None	Mobile	Users
None	Last Name	Users
None	last login	Users
Current Value	Language Preference	Users
Old Value	Is Sugar User	Users
Current and Old Values	IM Type	Users
None	IM Name	Users
None	Home Phone	Users
None	Group User	Users
Current Value	First Name	Users
None	Fax	Users

- The template's design view will once again be visible and the selected variables will appear where your cursor was positioned before clicking the Fields Selector icon. The variables are wrapped in curly braces and must retain their special formatting to be detected in the sent message.

<> **B** *I* U ~~S~~ **A** **A**

Font Sizes Paragraph

Dear {::assigned_user_link::last_name::}{::assigned_user_link::first_name::},

If necessary, use the text editor to move the variables or insert additional characters. In this example, we will move the first name variable {::assigned_user_link::first_name::} into position before the last name variable and insert a space character in between the two:

Dear {::assigned_user_link::first_name::} {::assigned_user_link::last_name::},

- Next, place the cursor where you would like to insert the old and new values of the case's Status field then open the Fields Selector drawer again.

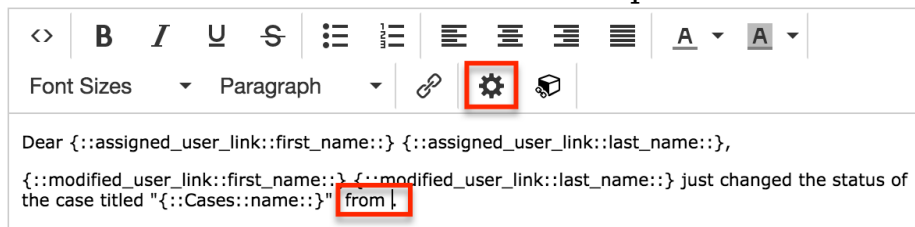

Dear {::assigned_user_link::first_name::} {::assigned_user_link::last_name::},
{::modified_user_link::first_name::} {::modified_user_link::last_name::} just changed the status of the case titled "{::Cases::name::}" from |

- In the drawer, open the dropdown adjacent to the Status field and select "Current and Old Values" then click "Done". Both variables will be inserted into the message.

Note: Before using current and old values in your message's template, be sure to refer to the [Understanding Current and Old Values](#) section for important usage information regarding your process definition's design.

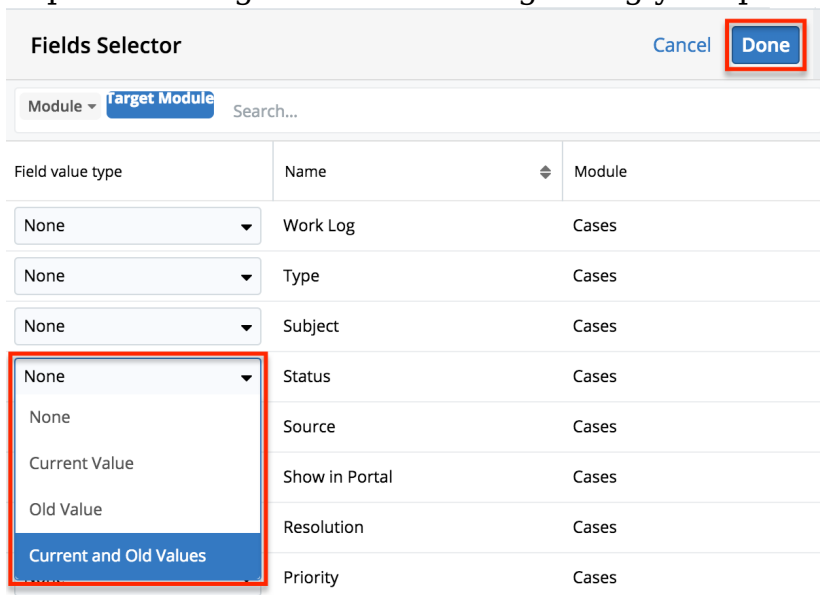

Field value type	Name	Module
None	Work Log	Cases
None	Type	Cases
None	Subject	Cases
None	Status	Cases
None	Source	Cases
Current Value	Show in Portal	Cases
Old Value	Resolution	Cases
Current and Old Values	Priority	Cases

- If necessary, reorganize the text to place the current and old variables where desired. In this example, we will put the old value before the current one and complete the sentence:

from {::Cases::status::old::} to {::Cases::status::}.

- Continue editing the template as needed and save.

The final product may look similar to this:

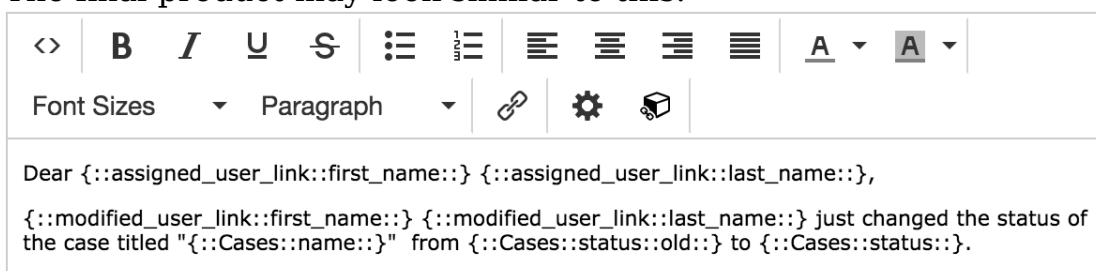

Dear {::assigned_user_link::first_name::} {::assigned_user_link::last_name::},
{::modified_user_link::first_name::} {::modified_user_link::last_name::} just changed the status of the case titled "{::Cases::name::}" from {::Cases::status::old::} to {::Cases::status::}.

For information about using process email templates in process definitions, refer to the [Send Message Events](#) section of the Process Definitions documentation.

Understanding Current and Old Values

When utilizing the Fields Selector tool to insert the current or old value of a field, it is important to strategically position the [Send Message event](#) within your process definition's design. Keep in mind the following guidelines:

- If the value of a field did not change during the action that triggers the Send Message event, both the Old Value and Current Value variables will display the current value. Therefore, only use the Old Value variable when a specific field is expected to change during the triggering event.
- If the value of a field changes more than once in a process, then its old and current values will be determined by the event that most closely precedes the Send Message event.
- If your process definition contains a Wait event, be sure that the Wait event does not occur between the action that changes the field and the Send Message event. This would prevent the old value from being communicated to the Send Message event.
- Old values of related-module fields are only preserved if they are changed within the same save, such as a Change Field event in the process or a logic hook that is triggered during the process.

For information about using process email templates in process definitions, refer to the [Send Message Events](#) section of the Process Definitions documentation.

Using the Record Link Selector Tool

If desired, you may insert a URL in the message content that links to the target record or a record from a related module. For example, an email template triggered from the Cases module could contain a link to the related case record in Sugar.

Note: Related-module links will only be available for modules that have a one-to-many relationship with the target module.

To insert a link using the Record Link Selector tool, follow these steps:

1. From the Process Email Template's design view, place the cursor in the message body where you want to insert a record link. Click on the Record Link Selector icon in the design toolbar.

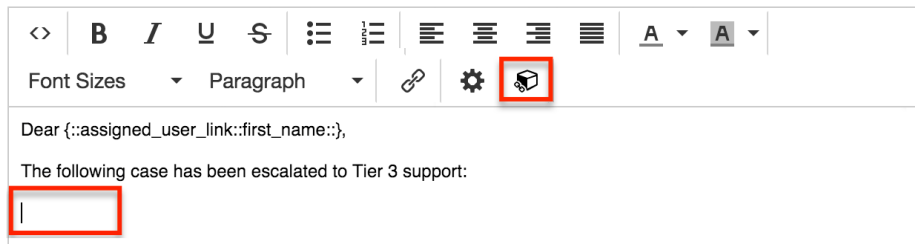

2. The Record Link Selector drawer will open over the current screen, displaying the name of the target module on the first line followed by the names of modules that have a one-to-many relationship with the target module. Click on the radio button next to the module that contains the record you want to link to and then click "Select".

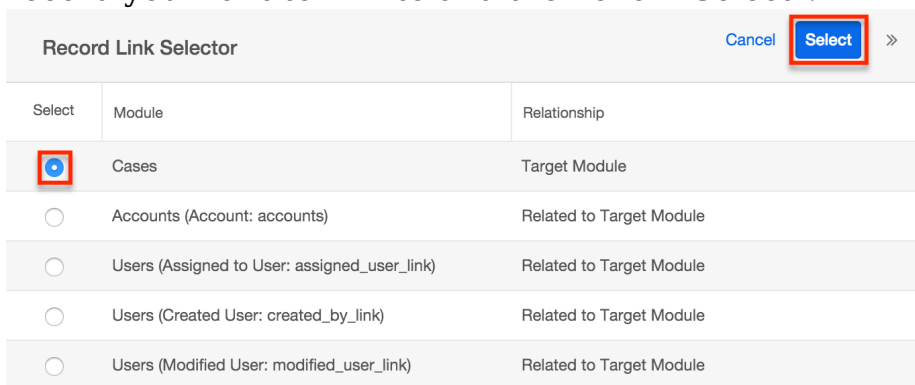

3. The template's design view will once again be visible and a variable representing the selected URL will appear where your cursor was positioned before clicking on the Record Link Selector icon.

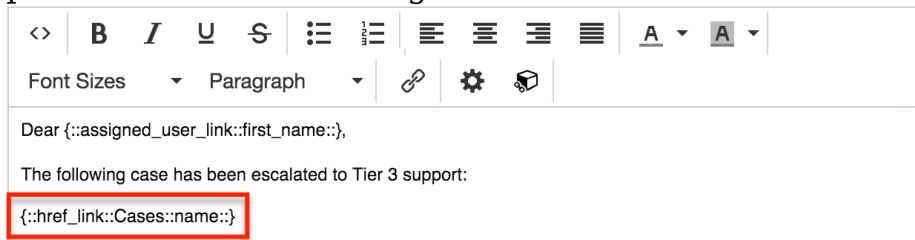

Note: In the recipient's inbox, the message will contain an unformatted URL (e.g., <https://instancename.com/#Cases/1234-abcd-5678-efgh>) that links to the related record. To instead display a word or phrase hyperlinked to the record, you can click on the Edit HTML Source button in the [design toolbar](#) and place the link variable in an HTML anchor tag:

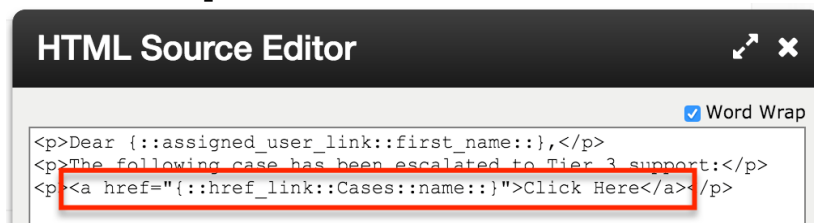

4. After completing the content of the message, click "Save & Exit".

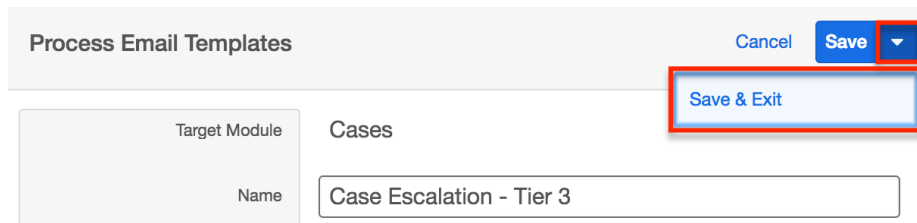

Process Email Templates

Cancel Save

Target Module Cases

Name Case Escalation - Tier 3

Save & Exit

For information about using process email templates in process definitions, refer to the [Send Message Events](#) section of the Process Definitions documentation.

Last Modified: 2020-01-24 20:48:45

Stock SugarBPM Templates

Overview

[SugarBPM™](#) has a number of pre-built, stock process definitions, process business rules, and process email templates that are available depending on your license type. These templates work together to automate common business processes (e.g. Service Level Agreement management on cases). This page lists and describes each of the stock process definitions, including their associated business rules and email templates, that come out-of-the-box for users with the required license type. For more information on license types, refer to the [User Management](#) documentation.

Before continuing, please read the [SugarBPM](#) overview page, which defines critical vocabulary and other elements that may be referenced in this page.

The SugarBPM documentation contains the following pages:

- [SugarBPM](#) (overview)
- [Process Definitions](#)
- [Process Business Rules](#)
- [Process Email Templates](#)
- Stock SugarBPM Templates (current page)

Additionally, the [Processes](#) page of the Application Guide contains documentation for the user-facing elements of SugarBPM. Please note that SugarBPM is not available for Sugar Professional.

Viewing Stock SugarBPM Templates

All of the available stock SugarBPM templates can be accessed via their respective modules: [Process Definitions](#), [Process Business Rules](#), and [Process Email Templates](#). They can be identified by a tag that indicates they are a stock record:

SugarBPM Module	Tag
Process Definitions	Stock Process Definition
Process Business Rules	Stock Business Rule
Process Email Templates	Stock Email Template

Each stock record also has a category tag such as "Customer Service" or "Sales". Users can filter each list view by tag as explained in the [User Interface](#) documentation.

To see which tags a record has, you can view the Tags field on the record or preview it in list view using the eye icon. Refer to the [Tags](#) documentation for more details on how tags work and the [User Interface](#) documentation for more information on previewing records.

Restoring Stock SugarBPM Templates

If you wish to undo all changes to a stock Sugar BPM record and restore it to its original state, you can do so by [filing a case](#) with the Sugar Support team.

Stock Process Definitions

The sections below list all stock process definitions in Sugar and the stock business rules and email templates that they use. To view the SugarBPM records, you must be an administrator or having developer-level role access for the record's target module. Additionally, each template requires the user to have either a Sugar Sell or a Sugar Serve license type.

Sell Templates

The SugarBPM templates in this section help to automate sales processes around leads, opportunities, and quotes. To access these templates, users must have a Sugar Sell license type. See the [License Types](#) documentation for more information

on how licenses work.

Automatically update your sales forecast - Opportunities Only

Overview

Target Module	Associated Process Business Rules	Associated Process Email Templates
Quotes		

Description

When a quote closes, this process definition automatically updates the related opportunity's sales stage based on whether the quote was won or lost. In either case, it also sets the opportunity's likely value to the quote's grand total.

Configuration Notes

The process definition uses the stock Quote Stage field on quotes and the stock Likely and Sales Stage fields on opportunities. If you use different fields or have customized the fields or field values in your instance, you may need to update the following elements:

- Start event
- Gateway element
- Change Fields events

If you update your instance to use revenue line items, disable this process definition and configure and enable the "Automatically update your sales forecast - Opportunities With RLIs" process definitions instead. Note that there are two parts.

Automatically update your sales forecast - Opportunities With RLIs Part 1

Overview

Target Module	Associated Process Business Rules	Associated Process Email Templates
Quotes		

Description

When a quote closes, this process definition automatically updates the sales stage on all of the related opportunity's revenue line items based on whether the quote was won or lost. If the quote was won, the process definition also sets the quoted line items' status to Ordered.

Configuration Notes

This process definition is part 1 of 2 in the "Automatically update your sales forecast - Opportunities With RLIs" flow. Please also configure and enable part 2 of 2 which completes the remainder of the steps.

The process definition uses the stock Quote Stage field on quotes, Status on quoted line items, and Sales Stage on revenue line items. If you use different fields or have customized the fields or field values in your instance, you may need to update the following elements:

- Start event
- Gateway element
- Change Fields events

If you update your instance to use opportunities only, disable this process definition as well as part 2 and configure and enable the "Automatically update your sales forecast - Opportunities Only" process definition instead.

Automatically update your sales forecast - Opportunities With RLIs Part 2

Overview

Target Module	Associated Process Business Rules	Associated Process Email Templates
Quoted Line Items		

Description

When a quoted line item's status changes to Ordered, this process definition automatically updates the associated revenue line item's likely value, quantity, and sales stage.

Configuration Notes

This process definition is part 2 of 2 in the "Automatically update your sales forecast - Opportunities With RLIs" flow. Please also configure and enable part 1 of 2 which completes the first set of steps.

This process definition updates the revenue line item that is related to the target quoted line item. However, it is important to note that this relationship only exists if the quote containing the quoted line item was created via the Generate Quote option on an opportunity record's Revenue Line Items subpanel. If the quote was created manually, the relationship will not exist and therefore this process definition will not update anything.

The process definition uses the stock Status field on quoted line items, and Likely, Quantity, and Sales Stage on revenue line items. If you use different fields or have customized the fields or field values in your instance, you may need to update the following elements:

- Start event
- Change Fields event

If you update your instance to use opportunities only, disable this process definition as well as part 1 and configure and enable the "Automatically update your sales forecast - Opportunities Only" process definition instead.

Route Lead and Create Follow-Up Task

Overview

Target Module	Associated Process Business Rules	Associated Process Email Templates
Leads	<ul style="list-style-type: none">• Global Territory Lead Routing• USA Regions	<ul style="list-style-type: none">• Lead Assignment Notification

Description

All newly created leads are routed to their appropriate territory and assigned via round robin to sales representatives in that territory. If a lead cannot be automatically assigned, it is instead escalated to the sales manager for manual assignment.

Once a lead is assigned, the sales representative receives an email notification and the system creates a task for the assignee to follow up with the lead. The task's due date is set to 8 business hours after the lead is assigned, which is calculated

based on the business center associated with the lead. If there is no business center associated with the lead, the task will not have a due date.

If a lead's status is updated to Recycled or Dead during routing, the process terminates immediately.

Configuration Notes

The Global Territory Lead Routing and USA Regions process business rules may need to be updated to align with your organization's territories. If so, the gateways in the process definition must also be updated to match the results returned by the business rules.

You must also select the appropriate team for the round robin events for each territory because the Global team is selected by default.

The Sales Manager to Route Lead activity is assigned to the administrator by default. You must update this to the manager in your organization who will manually assign leads that were not routed by the process.

Lastly, if you have customized the Status field in the Leads module, you may need to update the process definition to use the custom values in the Terminate Process criteria.

Stagnant Opportunity Reminder (Opportunities Only)

Overview

Target Module	Associated Process Business Rules	Associated Process Email Templates
Opportunities		<ul style="list-style-type: none">• 15 Day or Less Opportunity Reminder• Opportunity Expected Close Date Passed

Description

This process definition sends an email notification to the assigned sales representative when an open opportunity is 15 days away from its expected close date. If the opportunity does not close by this date, the process then sends a follow-

up email to the sales representative.

Configuration Notes

The process definition uses the stock Expected Close Date and Sales Stage fields. If you use different fields or have customized the fields or field values in your instance, you may need to update the following:

- Start event for updated records
- Receive Message event
- Terminate Process criteria

If you update your instance to use revenue line items, disable this process definition and configure and enable the Stagnant Opportunity Reminder (Opportunities with Revenue Line Items) process definition instead.

Stagnant Opportunity Reminder (Opportunities with RLIs)

Overview

Target Module	Associated Process Business Rules	Associated Process Email Templates
Opportunities		<ul style="list-style-type: none">• 15 Day or Less Opportunity Reminder• Opportunity Expected Close Date Passed

Description

This process definition sends an email notification to the assigned sales representative when an open opportunity is 15 days away from its expected close date. If the opportunity does not close by this date, the process then sends a follow-up email to the sales representative.

Configuration Notes

The process definition uses the stock Expected Close Date and Status fields. If you use different fields or have customized the fields or field values in your instance, you may need to update the following:

- Start event for updated records
- Receive Message event
- Terminate Process criteria

If you update your instance to use opportunities only, disable this process definition and configure and enable the Stagnant Opportunity Reminder (Opportunities Only) process definition instead.

Quote Approval When Discount Exceeds 20%

Overview

Target Module	Associated Process Business Rules	Associated Process Email Templates
Quotes		<ul style="list-style-type: none"> • Discount Approval Notification

Description

If a quote is being negotiated and its total discount exceeds 20%, an approval request is sent to the sales representative's supervisor. If the discount is approved, the process sends an email notification to the sales representative to let them know. If not, a task is assigned to the sales representative to review the discount options instead.

While awaiting approval from the supervisor, the Discount and Quote Stage fields are locked and cannot be edited until the supervisor reviews the quote.

Configuration Notes

The list of users from which the supervisor can choose a new assignee for the process and quote is set to the Global team by default. If you want this to be more restrictive, you can update the approval activity to list different teams based on your Sugar instance's teams configuration.

If you have customized fields in the Quotes or Tasks modules, you may need to update the process definition to use the custom fields or their values. Fields used that are more likely to be customized include Quote Stage in the Quotes module and Status in the Tasks module.

Serve Templates

The SugarBPM templates in this section help to automate customer service processes around cases and notes. To access these templates, users must have a Sugar Serve license type. See the [License Types](#) documentation for more information on how licenses work.

Case Follow-Up Date Management V2

Overview

Target Module	Associated Process Business Rules	Associated Process Email Templates
Cases	<ul style="list-style-type: none">• New Case SLA V2	<ul style="list-style-type: none">• Follow-Up Warning V2• Case Assigned V2• Notify Manager: SLA Missed V2

Description

This SugarBPM template is a revision of the original version that was included in Sugar Serve 9.1. The V2 version is available in Sugar Serve 9.3 and higher and includes new functionality. For details on the new functionality and how to configure it, refer to the [Stock SugarBPM - Case Follow-Up Date Management](#) article.

This process definition updates the case's Follow-Up Date and sends email notifications during the lifecycle of new and updated cases. It can be broken down into three general stages: new case assignment and initial response, existing case waiting on the customer service representative, and existing case waiting on the customer.

New Case Assignment and Initial Response:

When a new case is created, the process calculates and sets the follow-up date, assigns the case to a customer service representative, notifies them, and waits to ensure that the follow-up date is met by a status change before advancing to the next stage. If it is not met, the process sets the SLA Met field to "No", sends an email notification to the representative's supervisor, and continues to wait for a status change before advancing.

Existing Case Waiting on the Customer Service Representative:

The process waits for a status change on the case and then updates the follow-up date using the business center's business hours and sets the First Response Sent field to "Yes". If the status changes to any open status other than "Pending Input",

the process adds 8 business hours to the follow-up date. It then waits for another status change while the customer service representative works on the case.

Existing Case Waiting on the Customer:

If the status changes to "Pending Input", the process adds 16 business hours to the follow-up date then waits for the customer to respond. If they do not respond by the follow-up date, an additional 16 business hours are added and the process sends an email to the customer notifying them that the case is awaiting their response. If the customer sends an email related to the case, the case status is changed to "Assigned". However, if they do not respond by the new follow-up date, then the case is automatically closed.

Configuration Notes

Refer to the [Getting Started With SugarBPM for Sugar Serve](#) and [Stock SugarBPM - Case Follow-Up Date Management](#) articles for help configuring this process definition and your instance to work together.

Case Status Update on Inbound Customer Note

Overview

Target Module	Associated Process Business Rules	Associated Process Email Templates
Notes		

Description

This process definition changes a case's status from Pending Input to Assigned when a customer adds a note to the case.

Configuration Notes

If you have customized the available values for the Status field in your Cases module, you must update the following elements in the process definition to use the statuses available in your instance:

- Start Event
- Change Field Action

Customer Notification of Case Status Change

Overview

Target Module	Associated Process Business Rules	Associated Process Email Templates
Cases		<ul style="list-style-type: none">• Customer Notification of Case Status Change

Description

When a case's status changes except when changed by an Inbound Email, all contacts related to the case are notified via email.

New Portal User

Overview

Target Module	Associated Process Business Rules	Associated Process Email Templates
Contacts		<ul style="list-style-type: none">• New Portal Registration• Portal Registration Acknowledgement

Description

When a new contact is created in Sugar from a new portal registration, this process definition sends two emails. The first is sent to the assigned user of the new contact, informing them of the new portal user needing activation. The second is sent to the new portal user, acknowledging that their registration was submitted successfully.

New Note Notification

Overview

Target Module	Associated Process Business Rules	Associated Process Email Templates
Notes		<ul style="list-style-type: none">• Client Notification of New Note

-
- | | | |
|--|--|--|
| | | <ul style="list-style-type: none">• Agent Notification of New Note |
|--|--|--|

Description

When a new note related to a case is created, this process definition sends an email notification to the relevant party. If the client creates the note, the email is sent to the case owner. Otherwise, if the customer service representative creates the note, the email is sent to the primary contact on the case. If there is no primary contact, then the note description is updated to specify why no email notification was sent.

Last Modified: 2020-01-24 15:52:49

Tile View Settings

Overview

Tile View allows users to visualize and engage with their cases, opportunities, and tasks in an intuitive drag-and-drop interface. Users can drag tiles from one column to another to move a record from one status to another, or change the expected close dates on opportunities from one month to the next. Administrators can configure Tile View to fit their specific business needs by enabling and disabling modules, changing the visible columns, and selecting the fields displayed in each tile via Admin > Tile View Settings. This page describes how to configure the Tile Views in Sugar.

For information on using Tile View in Sugar, refer to the [User Interface](#) documentation in the Application Guide.

Note: The Cases module is not available for Sugar Sell users, and the Opportunities module is not available for Sugar Serve users. For more information on license types and the functionality available for each type, refer to the [User Management](#) documentation.

General Settings

Upon navigating to Admin > Tile View Settings, the Tile View administration

page's topmost section is labeled "General Settings". In this panel, you can [enable and disable Tile View access](#) for the available modules.

General Settings Fields

The General Settings section for Tile View administration contains the following field.

Field	Description
Modules List	Multiselect field used to enable and disable Tile View access for supported modules (Cases, Opportunities, and Tasks).

Enabling and Disabling Tile View

Use the Modules List field under General Settings to enable and disable access to Tile View for users. By default, Tile View is enabled for Cases, Opportunities, and Tasks.

To disable Tile View for a module, click the X next to its name to remove it from the Modules List field and then click "Save". To enable a module, click inside the Modules List field and select it from the list of supported modules.

Please note that the order of the module names will also control the order that the modules appear in the Module Settings tab below. Simply drag and drop the modules into your preferred order and then click "Save". The next time you visit Tile View Settings, the tabs under Module Settings will appear in the order that the modules were saved.

The screenshot shows the 'Tile View Settings' interface. At the top, there are 'Cancel' and 'Save' buttons. Below that, the 'General Settings' section is active, indicated by a circled '1'. The 'Modules List' field is highlighted with a red box and contains three selected modules: 'Cases', 'Tasks', and 'Opportunities', each with a small 'X' icon to its right. Below the 'General Settings' section, the 'Module Settings' section is visible, indicated by a circled '2'. It shows three tabs: 'Cases', 'Tasks', and 'Opportunities', with 'Cases' currently selected.

Module Settings

The Tile View administration page's lower section is labeled "Module Settings". In this panel, you can configure the available fields, field values, and columns shown for each module's Tile View.

Module Settings Fields

The Module Settings section for Tile View administration contains the following fields.

Field	Description
Module (tabs)	Use the Module tabs to navigate from one module's Tile View settings to another. Only the modules enabled in Tile View's General Settings will be shown.
Table Header	The field by which you want to group your Tile View. The field's values will be used as columns across the top of the Tile View. You may select any dropdown field.
Header Values	The Header Values section displays the field values for the field selected in the Table Header. Use drag and drop to move the fields between hidden and available and determine whether the field should be shown as a column: <ul style="list-style-type: none">• Available Values : These field values will be used as column headers in the Tile View.• Hidden Values : Records with these field values will not be shown in the Tile View and the values will not appear in the header.
Tile Options Header	Select the field whose value will be shown as the tile's clickable header.
Tile Options Body	Select the fields whose values will be shown in the tile's body beneath the Tile Options Header. Drag and drop the fields into the order that you want them to be listed.

Number of Records Displayed per Column

Select the number of records that each column in Tile View should load by default. Users will be able to manually scroll beyond this number of records to load additional tiles.

Configuring Tile View Column Headers

You can choose which field (e.g. Status, Priority) to group the Tile View by for each module. The columns displayed in the tile view's header are determined by the values (e.g. In Progress/Closed, High/Low) of that field.

Tasks by Status

Filter Search by subject...

Not Started	In Progress	Pending Input	Deferred
Send local user group infor... June Arends 2019-11-29 07:45am	Send literature Hal Archambeault 2019-09-05 11:30am	Close out support request Linnie Bondi X-Sell Holdings 2020-05-21 01:30pm	Send fax Makeda Gadbois 2019-11-07 08:45am
Make travel arrangements Justa Montesino 2020-01-05 06:45am	Send a letter Lashonda Hannum Kaos Trading Ltd 2020-01-07 12:15pm	Send quote Ronna Mccluney 2019-10-31 06:45am	Send quote Melvin Mcgilvery 2019-09-03 09:00am

Note: It is important to note that only dropdown fields are available to select for the Tile View header columns.

To configure the Tile View column headers, follow these steps:

1. Navigate to Admin > Tile View Settings > Module Settings.
2. Click on the tab for the module's Tile View that you would like to configure.

2 Module Settings

Cases **Tasks** Opportunities

3. In the Table Header field, select the dropdown field that you want to group your results by. This field's values will be used as columns across the top of the Tile View.
4. The Header Values section will automatically update with the values of the field you chose in the previous step. Move the fields to either the Hidden Values or Available Values side via drag and drop. Hidden values will not appear in the header and records that contain a hidden value will be omitted from the Tile View.

Table Header

Status ▼

Header values

Available values

Not Started
In Progress
Pending Input
Deferred

Hidden values

Completed

5. Click "Save" to preserve your changes or proceed to the next section for steps to [configure the appearance of individual tiles](#).

After saving the changes, there will be one column header for each value in the Available Values section. If there are no records that contain one of the Available Values, then that value's column will contain no records in Tile View until a record has been saved with that value. Tile View headers appear in the order that the values are saved in the field's [Dropdown Editor](#) list and are not affected by the order shown in the Tile View settings.

Configuring Tiles

The following steps explain how to configure the individual tiles to show your preferred fields. Take note that the Tile Preview in the Intelligence Pane will automatically update to reflect your selections as you change the tile-options fields.

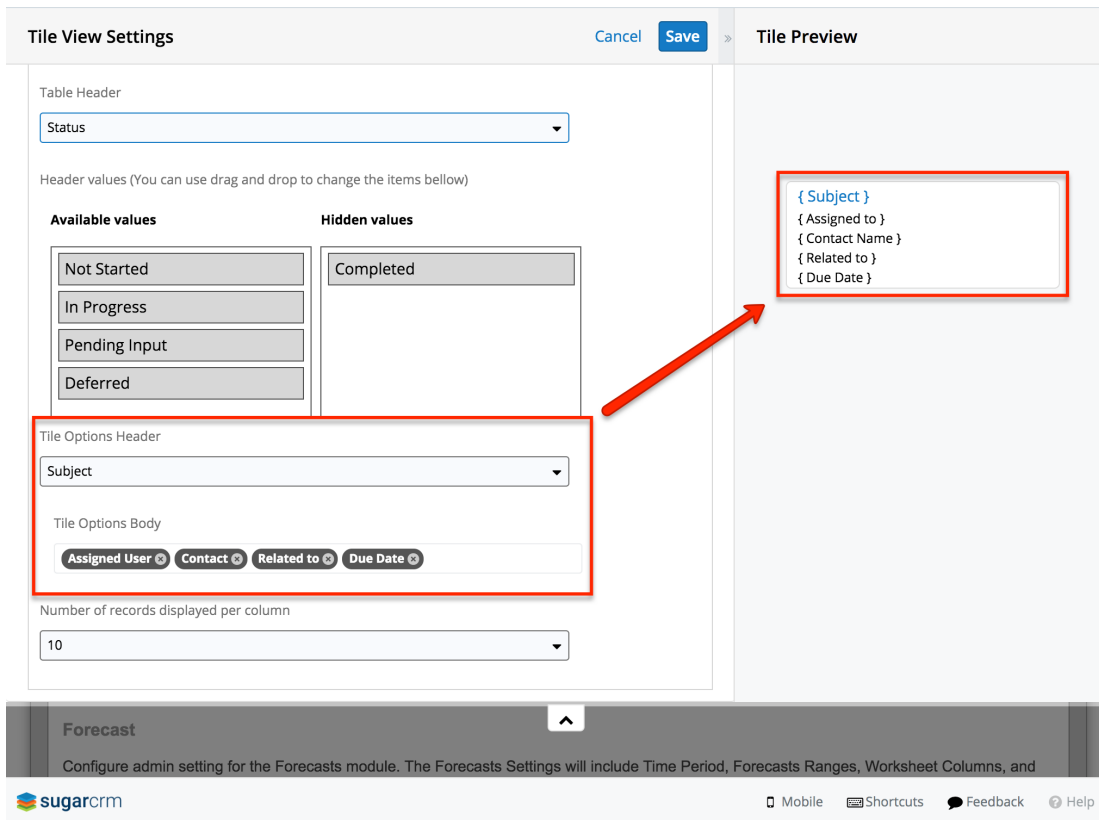

1. Navigate to Admin > Tile View Settings > Module Settings and click on the tab for the module's Tile View that you would like to configure. If you are continuing steps from the previous section, then simply proceed to the next step.
2. Locate the Tile Options Header field and select the field that you want to use as the topmost line of the tiles. This is typically the Subject or Name field, but can be configured as you please.

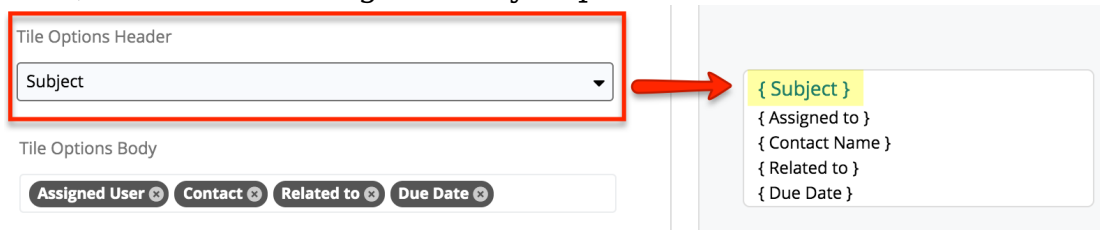

3. Next, select the fields that you want to appear under the Tile Options Header in the Tile Options Body field. You can drag and drop them into the order you want them to appear and see the Tile Preview update in real-time. Only stock fields can be displayed on tiles in Tile View.

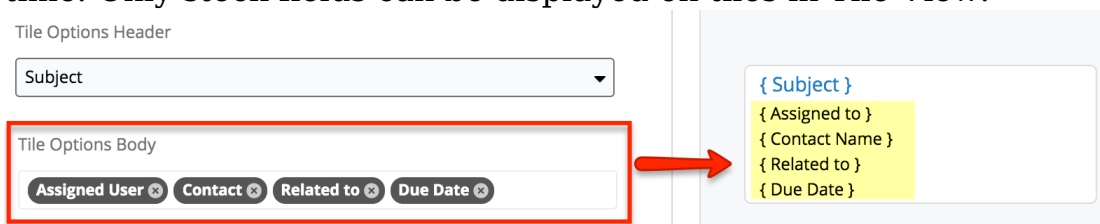

4. Click "Save" to preserve your changes.

Advanced Configuration Options

Overview

Sugar comes with many different ways to configure your system to best meet your needs. Many configuration options are available throughout the application; though, some advanced options are not available through the interface, but can still be configured.

In the root directory of Sugar, there are two configuration files: `config.php` and `config_override.php`. These files hold many configuration options within your instance of Sugar. The `config_override.php` file is available for you to modify Sugar's configuration. For more information on which options are available to change, please refer to the [Developer Guide](#).

Note: Instances running on Sugar's cloud service do not have access to modify the `config_override.php` file.

Maintenance Mode

On rare occasions, you may need to restrict users from logging in to Sugar. This is particularly useful when upgrading Sugar or making significant changes to the application (e.g. changing config values, making code-level changes, or deploying changes via Studio, Module Builder, or Module Loader). For these situations, we recommend enabling maintenance mode, which is disabled by default. With maintenance mode enabled, only administrators will be able to log in, and regular users will receive an alert on the login screen letting them know that the system is temporarily unavailable. All incoming API calls will also encounter an error message until maintenance mode has been disabled. When possible, it is best practice to notify affected users in advance of a maintenance period.

To enable maintenance mode for your instance, add the following line to the `config_override.php` file:

```
$sugar_config['maintenanceMode'] = true;
```

System Configuration

Changing values in the config files can change functionality and behaviors in Sugar. We always recommend testing your changes on a development or test system before changing values in a production system. After changing the `config_override.php` file, you should perform a Quick Repair and Rebuild from the Admin > Repair menu. For more information, please refer to the [Repair](#) documentation.

Configuring File Permissions

Many features in Sugar require the web server to have the proper file permission settings to be able to read and write files. At a minimum, the following files and directories need to be writable from your web server:

- `./config.php`
- `./config_override.php`
- `./sugarcrm.log`
- `./cache/` and all subdirectories and files
- `./custom/` and all subdirectories and files
- `./data/` and all subdirectories and files
- `./modules/` and all subdirectories and files

Sugar running on Windows with IIS will need the IIS user (`IUSR_[computerName]`) to have access to these files.

Sugar running on Linux expects the listed files and directories to be owned by the same user running the web server and to also be in the same group. Sugar would then require the following permissions:

- 2770 for the directories listed above
- 660 for the `config.php` file and all files in the directories listed above
- 770 for `bin/sugarcrm`

When running on Linux, the `config.php` file in your Sugar instance's root directory contains a setting called `default_permissions`. This setting controls the ownership and accessibility to all files and folders created by Sugar. The following is an example of setting Read, Write, and Execute permissions for the Apache user and the Apache group on CentOS operating system:

```
default_permissions' => array(  
    'dir_mode' => 1528,  
    'file_mode' => 432,  
    'user' => 'apache',
```

```
'group' => 'apache',  
) ,
```

The values for `dir_mode` and `file_mode` are decimal equivalent values for the standard octal values entered for permissions. The value 1528 is the decimal equivalent of the octal value 02770 and a value of 432 which is the decimal equivalent of octal value 0660. These are the recommended directory and file permissions for Linux systems.

Note: If the octal values are entered, they will be interpreted as decimal and will not provide the expected file permission settings.

The 'user' and 'group' values determine the ownership of the files created. When empty, your Apache settings will take precedence to determine file and directory ownership. These values should be set explicitly to the Apache user and group on your server and these values will vary depending on the Apache setup and/or Linux OS you are running. To update these values, please edit the `config_override.php` file in the root directory of your installation and add the following lines:

```
$sugar_config['default_permissions']['user'] = '<your Apache user>';  
$sugar_config['default_permissions']['group'] = '<your Apache group>';
```

Note: These values will take effect for only newly created files, not existing files. If you need to change the file permissions or ownership for existing files, you must execute the changes through the file system.

Allowing POP Email Accounts

Inbound email accounts are set up to work with IMAP protocols by default. If your email provider required POP3 access instead of IMAP, you can add the following line to the `config_override.php` file:

```
$sugar_config['allow_pop_inbound'] = true;
```

This will allow new inbound email accounts to be configured with POP3 or IMAP.

Note: POP3 access is not supported and can cause unintended consequences. IMAP is the recommended protocol to use for inbound email accounts.

Security Options

By default, all administrators have access to administrative tools in Sugar like the

Upgrade Wizard, Module Builder, and Module Loader. The following sections will show a few different ways to disable these options.

Locking Down Admin Control

If you are managing multiple instances of the Sugar application, you can maintain complete control over the Sugar instances by preventing users with administrative privileges from making any changes. To do this, you can lock down the Upgrade Wizard and Module Builder with a single command in the `config_override.php` file:

```
$sugar_config['admin_access_control'] = true;
```

Locking Down Module Loader

To ensure that users with administrative privileges do not load sub-standard modules into Sugar, you can restrict the Module Loader to a specific directory on the web server that you control. This allows you to check modules before they are loaded into Sugar. To restrict the module loader, simply add the following lines to the `config_override.php` file:

```
$sugar_config['use_common_ml_dir'] = true;
$sugar_config['common_ml_dir'] = '/Applications/MAMP/htdocs/sugarcrm/scr
eenedModules';
```

This will prevent any admin users from loading a module from any directory other than the specified directory. Once a module is approved through the necessary channels, the module can be placed in the specified directory for any admin to install when necessary.

New uploads for Module Loader are disabled. Installable modules are restricted to the modules pre-loaded below.

Name	Action
Bug_53944_656-661_PRO_CORP_ENT_ULI.zip	<input type="button" value="Upload"/>

Another method for locking down the module loader is to enable the package scanner. The package scanner is enabled by default for instances hosted on SugarCloud. If you are running Sugar on-site, you can enable the package scanner by adding the following command in the `config_override.php` file:

```
$sugar_config['moduleInstaller']['packageScan'] = true;
```

When the package scanner is enabled, the module loader will check the files being loaded for various functions that could be damaging to the server or instance of Sugar. For more information on which functions are blacklisted and how to configure the package scanner, please refer to the [Developer Guide](#).

Enabling Sites as Referers

To prevent Cross-Site Request Forgery (XSRF) attacks, Sugar has a list of acceptable sites that are allowed as a referer to Sugar. If you receive a "Possible Cross Site Request Forgery (XSRF) Attack Detected" message from an approved site trying to access Sugar, you can add that approved site's URL to the list of valid referers by adding the following line to the `config_override.php` file:

```
$sugar_config['http_referer']['list'][] = 'my.site.com';
```

This line will add the specified site to the list of approved sites. If you have multiple sites to add, repeat this line for each site required.

Performance

If the performance of your Sugar instance begins to degrade, there are some configuration options you can enable to lighten the load on your system. The following options may cause Sugar's performance to increase, but some performance gains will come with a loss of functionality.

Recommended Server Settings

Sugar recommends a PHP memory limit of at least 512MB. This value may need to be increased depending on how your users utilize Sugar. For example, operations such as mass update and imports may require additional memory depending on your instance size and configuration. To change this limit, edit the setting within `php.ini`:

```
memory_limit = 512M
```

In addition, `display_errors` should always be set to "off". Enabling this option can result in adverse behavior for your users. To turn this setting off, edit the option within `php.ini`:

```
display_errors = off
```

When making changes to either of these settings or any other settings within `php.ini`, you must restart the web server before the settings will take effect.

Limiting System Resources

Sugar allows non-admin users to be restricted to how many queries they can run per action. By default, the limit for all modules is set to 1000 queries. This prevents user-initiated processes from taking up too many system resources. If an operation is performed by a user that attempts too many queries they will see a message returned saying: "Error: Query limit of 1000 reached for Leads module." To change this limit for all modules, add the following line to the `config_override.php` file:

```
$sugar_config['resource_management']['default_limit'] = 5000; // default is 1000
```

Note: Setting the `default_limit` value to 0 will remove the query limit altogether for all modules.

In addition to setting the default for all modules, you can specify certain modules to have a different value. To remove the limit for specific modules only you need to specify the modules and the limit for those modules by adding the following lines to the `config_override.php` file:

```
$sugar_config['resource_management']['special_query_modules'][] = 'Accounts';  
$sugar_config['resource_management']['special_query_modules'][] = 'Contacts';  
$sugar_config['resource_management']['special_query_limit'] = 0; // default is 50000
```

In this example, the Accounts module, Contacts module, and any other module in the `special_query_modules` array will no longer be limited. All other modules will adhere to the default limit.

Note: Setting this limit too low can severely restrict users from performing basic actions. Alternatively, removing the limits altogether may let users inadvertently perform operations that significantly impact overall performance.

Configuring a Slave Database

Sugar allows you to configure your instance to pull reports or list view data from a slave database instead of your live database. Reports and list views can create a heavy load on the database, so separating out the reports or list view data on a different database or server can help alleviate some performance issues.

To configure a slave database, set the appropriate array in the `config_override.php` file:

- **Reports** : `$sugar_config['db']['reports']`

-
- **Dashlets, Subpanels, and List Views** : `$sugar_config['db']['listviews']`

Set the following values in the array to configure Sugar to use a slave database:

Key	Value
db_host_name	The host name of the server running the slave database
db_user_name	The user name to connect to the slave database
db_password	The password to connect to the slave database
db_name	The name of the slave database
db_type	The type of database running the slave (DB2, mysql, mssql, oracle)

For example:

```
$sugar_config['db']['reports'] =  
    array(  
        'db_host_name' => 'sugar_slave',  
        'db_user_name' => 'ro_user',  
        'db_password' => 'ro_user_password',  
        'db_name' => 'sugarcrm_reports',  
        'db_type' => 'mysql',  
    );
```

Note: You must create the slave database and the sync mechanism to keep the slave up to date with the live database. The Sugar application will not sync data from the live database to the slave.

Changing the Upload Directory

Sugar stores content, such as images, documents, and installable modules, uploaded by users in the upload directory. Some of these documents may be large in size and can cause performance issues. Administrators can move the upload directory to a different location to ensure that enough space is available for uploads without affecting the system. You can change the location of the uploads to a different folder within the sugar directory or use an absolute path to place the folder anywhere in the file system. You can change this location by adding the following line to the `config_override.php` file:

```
$sugar_config['upload_dir'] = 'd:\upload\';
```

Note: Remember to copy files from the old upload directory into the new upload directory for accessibility. The upload directory should be writable by the user running the web server.

Changing the Cache Directory

Sugar uses a cache directory to store files (such as compiled templates, aggregated variable definitions, remote mailbox data, various cache files) produced by the system to optimize functionality and enhance system performance. These files can take considerable space, especially in larger systems. You can change the location of the cache to a different folder within the sugar directory or use an absolute path to place the folder anywhere in the file system. You can change this location by adding the following line to the `config_override.php` file:

```
$sugar_config['cache_dir'] = 'd:\cache\';
```

Some of the cache files can be accessed by direct URLs. So if you move the cache directory, you should also ensure that the URL `/cache/` (relative to the main Sugar site URL) on your web server is configured to refer to the new cache location. For more information on how to configure mappings between URLs and file system directories, refer to your web server documentation.

Note: The cache directory needs to be created first, or you may receive an internal server error. The cache directory should be writable by the user running the web server.

Configuring Count Queries

By default, list views and subpanels in Sugar return record counts. This can be convenient to know how many records were found for a specific search, but in order to retrieve the record count; Sugar needs to perform additional queries on the database. When there are large amounts of data, these queries can cause performance issues. You can disable these count queries in Sugar by adding the following line to the `config_override.php` file:

```
$sugar_config['disable_count_query'] = true;
```

Instead of seeing the total record count, you will see the current known record count with a plus sign next to it.

Disabling Related Calculation Fields

When a calculated field in Sugar uses the related function in the Sugar Logic, this will cause the calculated field to be executed when the related module is updated. This can cause a cascading effect through the system to update related calculated fields. When this happens you may receive a 502 Gateway Error. You can disable the related calculation field updates by adding the following line to the `config_override.php` file:

```
$sugar_config['disable_related_calc_fields'] = true;
```

Note: This is a global setting that will affect all modules. If you have a calculated field in Accounts that sums up all Opportunities for the account, setting this value to true will no longer update the opportunity account sum in Accounts until the account record itself is modified. However, if this setting is left disabled, the sum would update any time a related opportunity or the account is modified.

Disabling Automatic Searches

By default, list views in Sugar remember the last search performed by the current user in each module. While this can be convenient, it is sometimes unnecessary. If the last search performed in a module was an extensive search, the next time the user navigates to that module will inadvertently perform the search again. This can have a negative impact on performance in Sugar.

Set one of the following values for `$sugar_config['save_query']` in the `config_override.php` file to configure different options for saving list view queries:

Value	Description
all	Populates the last search and executes it Note: This is the default behavior in Sugar.
no	Discards the previous search and executes a search with no criteria
populate_only	Populates the last search but does not execute it

For example:

```
$sugar_config['save_query'] = 'populate_only';
```

Note: The `$sugar_config['save_query']` setting is not supported for Sidecar

modules and only applies to Legacy modules.

Configuring Cron for Schedulers

Sugar's scheduler jobs are executed by the cron utility which runs on your server. There are several configuration options available to ensure that long-running or failed scheduler jobs do not impede your other scheduler jobs from running in a timely manner.

First, `max_cron_runtime` determines how long a single job should be allowed to run. If a single job exceeds this limit, `cron.php` is aborted with the long-running job marked as in progress in the job queue. The next time cron runs, it will skip the job that overran the limit and start on the next job in the queue. Additionally, if the total running time of a single cron run across all current jobs exceeds `max_cron_runtime`, then cron will complete whatever job it is currently executing, then stop. The next time cron runs, it will pick up with the next queued job. The `max_cron_runtime` uses seconds as its units and defaults to 1800 (30 minutes). You may wish to adjust this number based on the typical time requirements of scheduler jobs in your instance.

By default, `max_cron_runtime` is not enforced on your instance. In order to enforce this limit, set `enforce_runtime` to true.

```
$sugar_config['cron']['enforce_runtime'] = true; // default is false
$sugar_config['cron']['max_cron_runtime'] = 1800; // seconds, default
is 1800
```

The timeout configuration controls how long cron will wait before re-starting a job that previously failed to complete. Once a job has been marked as in progress for longer than the timeout setting, the next cron run will mark the job as failed, making it eligible in the queue to be executed by the following cron run. The timeout uses seconds as its units and defaults to 3600 (1 hour). You may wish to adjust this number based on how quickly you wish a failed or long-running job to be reattempted. Please note that should `enforce_runtime` be set to false or your `max_cron_runtime` be longer than the timeout, a job which is running normally may be set to "failed" upon reaching this timeout limit.

```
$sugar_config['jobs']['timeout'] = 3600; // seconds, default is 3600
```

Last Modified: 2019-12-05 15:47:53

Business Center Management

Overview

Business centers represent your company's centers of operation. When they are related to your accounts and other records, they can be leveraged in reports and filters to add detail and differentiation to your Sugar data like any other related field. In addition, each business center describes a time zone, operating hours, and holidays so that a concept called "Business Hours" can be leveraged in [SugarBPM™](#). While some companies may only need to define one business center, others may segment their customers by geographical region, customer type, or other criteria and, therefore, require multiple business centers. For example, companies with wide geographical reaches can create business centers for each region, allowing them to use varying business hours on a per-region level.

Business centers are specified at the account level. When a case is created, the related account's Business Center field is copied to the case, though users can also manually set the field. Refer to the [Cases](#) documentation for more information. Records' related business centers can then be leveraged by business rules and processes crafted in SugarBPM. SLA management is achieved in Sugar Serve by a [stock SugarBPM template](#) leveraging related business centers to calculate case follow-up dates. Refer to the [Getting Started With SugarBPM for Sugar Serve](#) and [Stock SugarBPM - Case Follow-Up Date Management](#) articles for help configuring the stock template and your instance to work together.

This documentation covers information and actions specific to the Business Centers module, which is available exclusively for Sugar Serve and Sugar Sell users. For instructions concerning views and actions that are common across most Sugar modules, such as creating, editing, and deleting business centers, refer to the [Working With Sugar Modules](#) section of this page.

Please note that you will only be able to access business center records if your user has a Sugar Serve or Sugar Sell [license type](#), and as allowed by your [team membership](#) and [assigned roles](#). By default, only System Administrator users with a Sugar Serve or Sugar Sell license type have the ability to create, edit, delete, and merge business centers, though these abilities can be granted to regular users as described in the [Creating a Business Center Administrator](#) section below.

Business Center Fields

The Business Centers module contains a number of stock fields which come out-of-the-box with Sugar. For information on using and editing various field types, refer to the [User Interface](#) documentation.

Field	Description
Time Zone	The time zone where the business center is located
Business Hours	The hours of the day in which business is conducted at this business center Note: For more information, refer to the Setting Business Hours section.
Address	The business center's physical address
Teams	The Sugar team(s) assigned to the business center record
Assigned To	The Sugar user assigned to the business center record
Tags	User-created keywords that can be used to identify records in filters, dashlets, and reports Note: For more information on creating and using tags, please refer to the Tags documentation.
Date Created	The date the business center record was created
Date Modified	The date the business center record was last modified

Working With Sugar Modules

While the Business Center Management module has some features that only apply to business centers, it also uses the Sidecar user interface that most Sugar modules are based on. In the table below, the left column contains links to the User Interface page covering topics that are applicable to all Sidecar modules. The right column has links to sections of the current page that cover topics specific to business centers.

General Instructions for Working With Sugar Modules	Business-Centers-Specific Instructions
Use the links below to navigate to the User Interface page which covers topics generic to many Sugar modules.	When Business-Centers-specific help exists for each topic, use the links below to navigate to sections of the current page.
Creating Records	

Viewing Records	
Searching for Records	
List View	List View Mass Actions Menu List View Record Actions Menu
Record View	Record View Actions Menu
Intelligence Pane	
Editing Records	Setting Business Hours
Deleting Records	
Exporting Records	
Finding Duplicate Records	
Viewing Audit Logs	
Favoriting Records	
Following Records	
Sharing Records	

Business Center Menus

The Business Centers module contains various options and functionality which are available via menus in the module tab, list view, and record view. The following sections present each menu and its options with links to more information about each option in the User Interface documentation or within this page.

Module Tab Menus

The Business Centers module tab is typically found by clicking the "More" icon represented by three vertical dots to the right of the module tabs on the navigation bar at the top of any Sugar screen. The additional modules will appear on the list and you can click "Business Centers" to access the list view.

Once the Business Centers tab displays on the navigation bar, click the triangle within the tab to display the Actions, Recently Viewed, and Favorites menu. The Actions menu allows you to perform important actions (e.g. create, view, import) within the module. The [Recently Viewed menu](#) displays the last few business centers you most recently opened. The Favorites menu displays the last few business centers you most recently marked as favorites. For information about favoriting records in Sugar, please refer to the [User Interface](#) documentation.

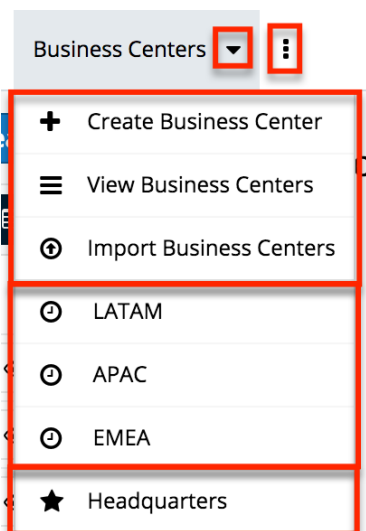

The Actions menu allows you to perform the following operations:

Menu Item	Description
Create Business Centers	Opens the record view layout to create a new business center record
View Business Centers	Opens the list view layout to search and display business center records
Import Business Centers	Opens the import wizard to create or update business center records using external data

If you do not see the Business Centers module tab in Sugar, please check the following:

- The Business Centers module may be marked as hidden in your user preferences, which will prevent the module tab from being displayed. Navigate to your user profile (upper right of Sugar), click the Advanced tab, and check the Layout Options section. If you see the Business Centers module in the Hide Modules list, simply move it to the Display Modules list and save. For more information on hiding and displaying modules, please refer to the [Layout Options](#) section of the Getting Started documentation.
- The administrator may have disabled the Business Centers module for your entire Sugar instance. Reach out to your Sugar administrator to have the Business Center module displayed. For more information on displaying and hiding modules throughout Sugar, please refer to the [Developer Tools](#) documentation in the Administration Guide.

List View Menus

The Business Centers [list view](#) displays all business center records and allows for searching and filtering to locate specific business centers. You can view the basic details of each record within the field columns of the list view or click a business center's name to open the record view. To access a module's list view, simply click the module's tab in the navigation bar at the top of any Sugar page.

List View Mass Actions Menu

The Mass Actions menu to the right of the checkbox option in the list header allows you to perform mass actions on all currently selected records. You can use the checkbox on each record's row to select individual business center records or click the checkbox in the list header to select all records displayed on the current set of list view results.

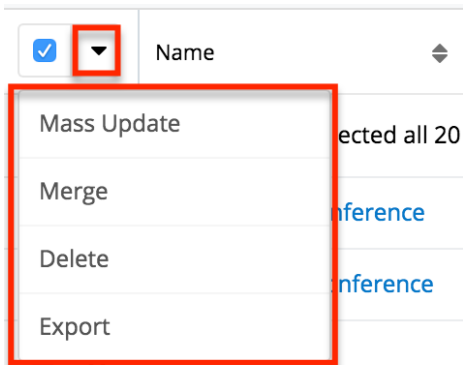

The Mass Actions menu allows you to perform the following operations:

Menu Item	Description
Mass Update	Mass update one or more business center records at a time
Merge	Merge two or more duplicate business center records
Delete	Delete one or more business center records at a time
Export	Export one or more business center records' data to a CSV file

List View Record Actions Menu

The Record Actions menu to the far right of each record's row allows you to perform actions on a business center record directly from the list view.

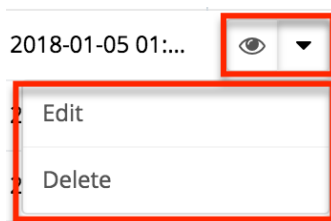

The options in the Record Actions menu allow you to perform the following operations:

Menu Item	Description
Preview (eye icon)	Preview this record in the intelligence pane
Edit	Edit this record
Delete	Delete this record

Record View Actions Menu

The Business Center [record view](#) displays a single business center record in full detail including its relevant fields and subpanels of related records. To access a business center's record view, simply click on the business center's name from the list view, dashlet, or from report results. The record view's Actions menu appears on the top right of the page and allows you to perform various operations on the current record.

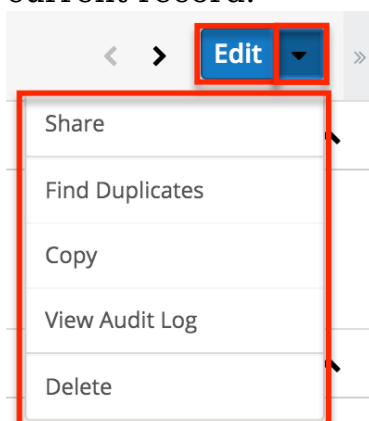

The Actions menu allows you to perform the following operations:

Menu Item	Description
Edit	Edit this record

Share	Share a link to this record via email
View Audit Log	View a list of changes that have been made to this business center record
Delete	Delete this record

Setting Business Hours

Creating a business center and setting its business hours is only available to Sugar Serve and Sugar Sell users who are administrators or who have Admin-level role access to the Business Centers module as explained in the [Creating a Business Center Administrator](#) section. To set business hours, navigate to the Business Hours panel on a business center's record view and enter the hours of operation for each day of the week. For each day's "Hours" field, select one of the following options:

- **Open** : The business center has operating hours on this day of the week. After selecting "Open", you must select the Open Time and Close Time for the day. The default open hours are 8:00 AM - 5:00 PM.
- **Open 24 Hours** : The business center's operating hours are 12:00 AM - 11:59 PM.
- **Closed** : The business center does not have operating hours on this day of the week.

Each business center's specified operating hours can be used in SugarBPM's business hour calculations. After setting the business center's hours, you can [designate the holidays](#) for which each business center will be closed.

Business Holidays and Business Centers

Below a business center record are several subpanels including the Business Holidays subpanel. This subpanel allows administrators to create one-day holiday records for a business center. Holidays will not be included in business hour date and time calculations used by SugarBPM in Sugar Serve and Sugar Sell. Holidays can be added by clicking the Create icon (+) in the Business Holidays subpanel.

Holidays contain three fields:

Field	Description
Holiday Name	A descriptive label for the holiday Note: It is recommended to utilize a standard format that includes the

	calendar year (e.g., "2020 Independence Day") in the Holiday Name field.
Holiday Date	The year, month, and day that this holiday occurs Note: For holidays that span multiple days, separate Business Holiday records must be created for each day.
Description	A brief description or reason for the holiday

Holidays created from a business center's subpanel are automatically related to that business center. The same holiday can be used for additional business centers by using the Link Existing Record option in the Business Holidays subpanel for the other business centers:

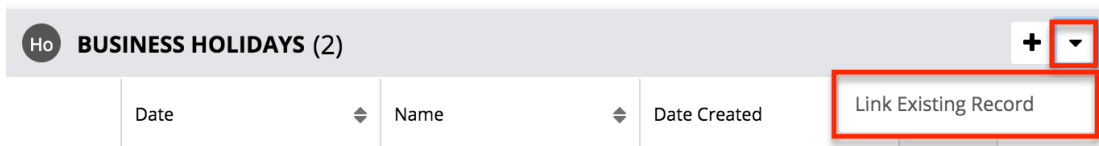

Creating a Business Center Administrator

By default, only System Administrator users with a Sugar Serve or Sugar Sell license type have the ability to create, edit, delete, and merge business center records in the Business Centers module. It may be helpful to delegate these administrative tasks to one or more designated user(s) without giving them full administrative permissions in Sugar.

Use the following steps to create a Business Center Administrator role:

1. Navigate to Admin > Role Management.
2. Click the triangle in the Roles module tab and select "Create Role".

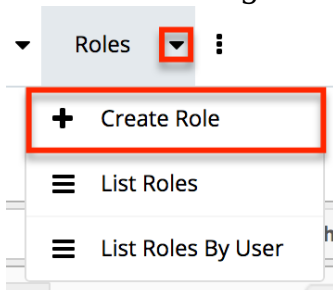

3. Enter a name (e.g. Business Center Admin) for the role then click "Save".
4. On the Role Chart screen, click "Business Centers" in the module's list to the far left of the page.

Double click on a cell to change value.

All	Save
Accounts	
Bugs	
Business Centers	Accounts
Calls	

- The screen will display the role settings specific to the Business Centers module. The Access and Access Type columns will default to "Not Set". Click directly on the "Not Set" text for each column and select the following options:

- **Access** : Enabled

Note: Access Type settings can remain as "Not Set" since the Admin access type will ensure full access to the remaining options.

Name:	Business Center Admin
Description:	

Double click on a cell to change value.

All	Business Centers	Save	Cancel							
Accounts				Access	Access Type	Delete	Edit	Export	Import	List
Bugs				Enabled	Admin	Not Set	Not Set	Not Set	Not Set	Not Set
Business Centers										
Calls										
Cases										
Comment Log										

- Click "Save" to preserve the changes.
- Scroll to the Users subpanel on the bottom of the screen and click "Select User". Search and select the user(s) you wish to assign this role to.

^ Users

Select User	(0 - 0 of 0)		
Name	User Name	Email	Phone
No data			

- After selecting the user(s), navigate to the user's profile to view their access information via the Access tab. Confirm that the Business Center Admin role is displayed in the Roles subpanel and the Business Centers module's access is set to "Admin".

Will Westin

Edit

User Profile	Advanced	Access							
	Access								
	Access	Access Type	Delete	Edit	Export	Import	List	Mass Update	View
Accounts	Enabled	Normal	All	All	All	All	All	All	All
Bugs	Enabled	Normal	All	All	All	All	All	All	All
Business Centers	Enabled	Admin	All	All	All	All	All	All	All
Calls	Enabled	Normal	All	All	All	All	All	All	All

Any user assigned to the Business Center Admin role will have the ability to access increased functionality such as creating, editing, deleting, and merging records in the Business Centers module. For more information on creating roles, please refer to the [Role Management](#) documentation.

Last Modified: 2020-01-09 21:06:29

Employee Records

Overview

Sugar's Employees module consists of individual people within your organization. The Employees module allows you to see a list of all employees, their contact information, and their employment status in one convenient location. Employee records are typically created when a user record is created, but users with administrative access can also add non-user employees. This means that, typically, all users will be listed as employees, but not all employees are necessarily Sugar users.

Note: For instances that use SugarIdentity, the administrator will need to access [SugarIdentity](#) via the Cloud Settings console to create and manage user records.

As the Employees module contains internal information about your company, not specifically Sugar, it is not subject to [team](#) and [role](#) restrictions.

Employee Fields

The Employees module contains a number of stock fields which come out-of-the-box with Sugar. The below definitions are suggested meanings for the fields, but the fields can be leveraged differently to best meet your organization's needs. Fields can be altered, added, or removed via Admin > Studio. For more information on configuring fields, please refer to the [Studio](#) documentation in the Administration guide.

For instances that use SugarIdentity, the administrator will need to access [SugarIdentity](#) via the Cloud Settings console to edit the following read-only fields for any employee records that are tied to a user record in SugarIdentity:

- First Name
- Last Name

- Title
- Department
- Office Phone
- Primary Address
- City
- State
- Postal Code
- Country
- Primary Email Address

Field	Description
City	The city of the employee's address
Country	The country of the employee's address
Department	The department where this employee works
Email Address	The employee's email address
Employee Status	The employee's employment status in the organization, either: Active, Terminated, or Leave of Absence
Fax	The employee's fax number
First Name	The employee's first name
Home Phone	The employee's home phone number
IM Name	The employee's instant message screen name
IM Type	The employee's instant message client type
Last Name	The employee's last name
Mobile	The employee's mobile phone number
Notes	A description or other information about this employee
Office Phone	The employee's office phone number and extension
Other	An additional phone number for the employee
Picture	A picture, headshot, or identifying image of the employee
Primary Address	The number and street of the employee's address
Postal Code	The postal code of the employee's

	address
Reports to	This field list's the employee's manager, if the manager is a Sugar user
State	The state of the employee's address
Title	The employee's job title

Employees Module Tab

The Employees module tab can be accessed by clicking your profile icon and selecting "Employees" in the user menu.

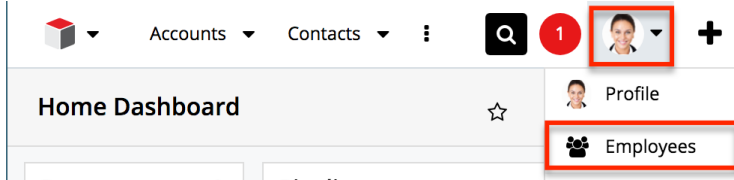

Once in the Employees list view, you can click the triangle in the Employees module tab to display the Actions and Recently Viewed menus. The Actions menu allows you to perform important actions within the module. The [Recently Viewed menu](#) displays the list of employees you last viewed in the module. Please note that clicking the module tab allows you to access the Employees list view.

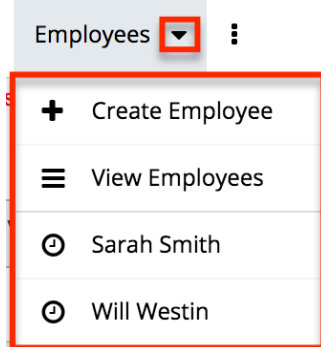

The Actions menu allows you to perform the following operations:

Menu Item	Description
Create Employee	Opens the edit view layout to create a new employee
View Employees	Opens the list view layout to search and display employees

Creating Employees

There are various methods for creating employees in Sugar including via the Employees module, the Users module, and duplication. The full edit view layout opens when creating the employee directly from the Employees menu and includes all of the relevant fields for your organization's employees. The edit view layout can be configured via Admin > Studio. For more information on configuring layouts, please refer to the [Studio](#) documentation. Please note that when a new [user](#) is created, an employee record is also created by default using the relevant information from the user record. For instances that use SugarIdentity, an administrator will need to access SugarIdentity via the Cloud Settings console in order to [create](#) new users.

Creating Via Employees Module

One of the most common methods of employee creation is via the Create Employee option in the Employees module tab. This opens up the edit view layout which allows you to enter in all the relevant information for the employee.

Use the following steps to create an employee via the Employees module:

1. Click the triangle in the Employees module tab and select "Create Employee".

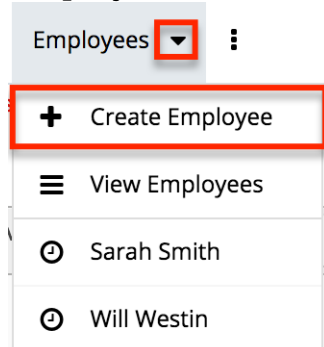

2. Enter appropriate values for the fields in the edit view layout. All required fields are marked with a red asterisk and must be completed prior to saving.
3. Once the necessary information is entered, click "Save".

Create

Employee Status:

First Name:

Creating Via Users Module

When a user is created, an employee record is also created by default using the relevant fields from the user record to be populated on the employee record. The field in the Users module that controls this is the "Display Employee Record" field. For more information on creating users, please review the [Users](#) documentation.

Note: For instances that use SugarIdentity, an administrator will need to access [SugarIdentity](#) via the Cloud Settings console in order to create new users.



Employee Information

Employee Status:

Title: Work Phone:

Creating Via Duplication

You can also create a new employee by duplicating an existing employee record. The Copy option is useful if the employee you are creating has similar information to an existing employee.

Note: The Copy option is not available for instances that use [SugarIdentity](#).

Use the following steps to create an employee by duplicating an existing record:

1. Navigate to an employee record's detail view.
2. Click the Actions menu and select "Copy".

» Will Westin

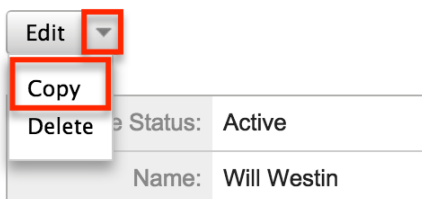

Edit

3. The displayed edit view is pre-populated with the original employee's

values. Update the necessary fields, then click "Save".

Create



The screenshot shows a form with two buttons at the top: a blue 'Save' button and a grey 'Cancel' button. Below the buttons is a horizontal line. Underneath the line, there are two fields. The first is labeled 'Employee Status:' and has a dropdown menu with 'Active' selected. The second is labeled 'First Name:' and has a text input field containing the name 'Will'.

Viewing Employees

There are various options available for viewing employee records in Sugar including via Employees list view, Employees detail view, and the Employees Recently Viewed menu. Please note that you will only be able to access these views by first clicking on the Employees button after clicking on your user name in the top right side of Sugar.

Viewing Via List View

The Employees list view displays all employee records meeting the current search criteria. To access the list view, simply click the Employees option under your user name on the module tab bar. While list view shows key employee fields, you can click the employee's name to open the record in detail view. For more information on viewing employees via list view, please refer to the [Employees List View](#) section of this documentation.

Viewing Via Detail View

The Employees detail view displays thorough employee information by showing all employee fields. The detail view can be reached by clicking an employee record's link from the Employees list view. For more information on viewing employees via detail view, please refer to the [Employees Detail View](#) section of this documentation.

Viewing Via Recently Viewed

As you work, Sugar will keep track of which employees you have recently viewed. Click the triangle in the [Employees module tab](#) to see a list of the 3 records you most recently viewed in the module. Clicking the record's name (e.g. Will Westin) within the list will open it in detail view.

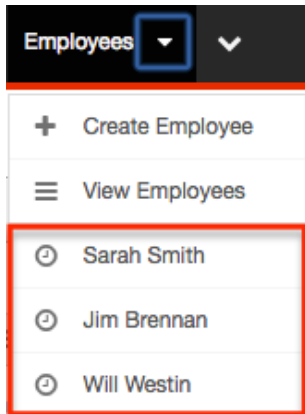

Searching Employees

The Employees list view includes a Basic and Advanced Search to help you locate records easily and effectively in a module-specific manner. Once the search is performed, the relevant results will be displayed in the Employees list view below. Please note that Sugar automatically appends the wildcard character (%) to the end of your search phrase. This allows the system to retrieve all records that start with the keyword entered in the search. If you would like to broaden the search, you can use the wildcard at the beginning of your text as well (e.g. %services). This will pull up any record that has the word "services" in the name, regardless of how it starts or ends.

For more information on using the various search methods as well as how wildcards are used in the different methods, please refer to the [Search](#) documentation.

Basic Search

Basic search offers a few, commonly used fields for a simplified search experience. From the Basic Search panel, you can click "Advanced Search" to access additional search functionality as needed.

The buttons and checkboxes available in Basic Search panel have the following functions:

- **Search** : Click the Search button or press your Return/Enter key to perform the search.
- **Clear** : Click the Clear button to clear all criteria from the searchable fields.
- **Active Employees** : Select this box to return only records where Employee Status is Active.

Search Employees

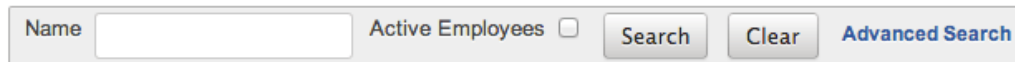

Name Active Employees [Advanced Search](#)

When you run a search, Sugar will return records matching all (as opposed to any) of the fields and checkboxes for which you have given a value. For example, if you select "Active Employees" and enter an employee's name, Sugar will only return employee records with a matching name that are active. Once the search is complete, the relevant results will populate in the [list view](#) below the search panel. To see all employee records, simply click "Clear" and then "Search" to perform a blank search with no filters.

Administrators can configure what fields appear on the Employees Basic Search via Admin > Studio. For more information on editing layouts, please refer to the [Studio](#) documentation in the Administration guide

Advanced Search

Advanced Search offers a more in-depth search experience than Basic Search including additional fields, layout options, and saved search capability. From the Advanced search panel, you can click "Basic Search" for simplified searching.

The buttons, checkboxes, and dropdowns available in Advanced Search have the following functions:

- **Search** : Click the Search button or press your Return/Enter key to perform the search.
- **Clear** : Click the Clear button to clear all criteria from the searchable fields.
- **Active Employees** : Select this box to return only records where Employee Status is Active.
- **Layout Options** : Use the expandable Layout Options section to configure your list view. For more information, please refer to the [Layout Options](#) section of the Search documentation.
- **Saved Searches** : Save, recall, update, and delete searches which you use often. For more information, please refer to the [Saved Search](#) section of the Search documentation.

When you run a search, Sugar will return records matching all (as opposed to any) of the fields and checkboxes for which you have given a value. For example, if you select "Active Employees" and enter an employee's name, Sugar will only return employee records with a matching name that are active. Once the search is complete, the relevant results will populate in the [list view](#) below the search panel. To see all employee records, simply click "Clear" and then "Search" to perform a blank search with no filters.

Administrators can configure what fields appear on the Employees Basic Search via Admin > Studio. For more information on editing layouts, please refer to the [Studio](#) documentation in the Administration guide.

Employees List View

The Employees list view displays all employee records meeting the current search criteria. You can view the basic details of each employee within the field columns.

You have the option to change what fields are displayed in the list view by configuring your layout options in the [Employees advanced search](#). For more information on configuring your list view, please refer to the [Layout Options](#) section of the Search documentation. Users with administrator or developer access also have the ability to change what fields are visible in the list view via Admin > Studio. For more information on editing layouts, please refer to the [Studio](#) documentation in the Administration guide.

Pagination

List view displays the current search results broken into pages that you can scroll through rather than displaying potentially thousands of rows at once. To the right just below the search panel you can see which records of the total results set are currently being displayed. The two single-arrow Next and Previous buttons can be used to scroll through the records page-by-page. The two double-arrow First Page and Last Page buttons allow you to skip to the beginning or the end of your current

results.

By default, Sugar displays 20 records per list view page, but administrators can change the number of records displayed via Admin > System Settings. For more information on changing the number of displayed records, please refer to the [System](#) documentation in the Administration guide.

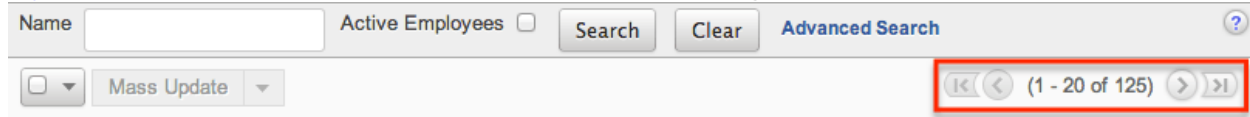

Checkbox Selection

You can perform actions on employee records directly from the list view by first selecting the desired records. To select individual employee records on the Employees list view, mark the checkbox on the left of each row. To select or deselect multiple case records on the list view, use the options in the checkbox dropdown menu:

- **Select This Page** : Selects all records shown on the current page of case results.
- **Select All** : Selects all records in the current search results across all pages of case results.
- **Deselect All** : Deselects all records that are currently selected.

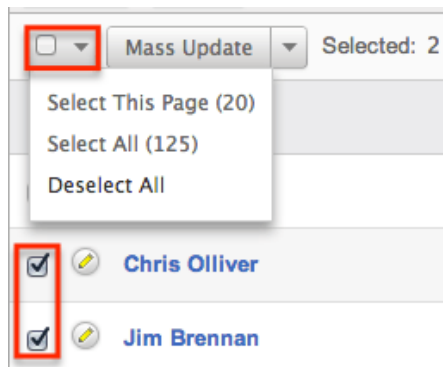

Actions Menu

The Actions menu to the right of the checkbox dropdown allows you to perform actions on the currently selected records.

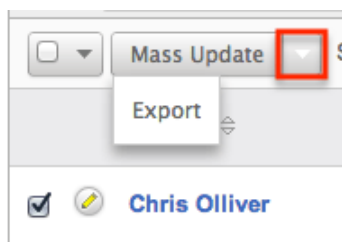

The options in the Actions menu allow you to perform the following operations:

Menu Item	Description
Mass Update	Mass update one or more employees at a time
Export	Export one or more employees to a CSV file

Column Sorting

List view provides the ability to sort all of the current search results by a field column in either ascending or descending order. To sort by a field or switch the sort direction, click the column header noting that the fields which allow sorting will have a pair of arrows. The list view may be sorted by only one column at a time. You can also set a default order-by column using the layout options in Advanced Search. For more information on setting a default column sort, please refer to the [Layout Options](#) section of the Search documentation.

Employees Detail View

The Employees detail view displays thorough employee information by way of all employee fields grouped into one page.

Users with administrator or developer access have the ability to change the detail view by configuring the layout via Admin > Studio. For more information on editing layouts, please refer to the [Studio](#) documentation in the Administration guide.

Next or Previous Record

On the upper right of the Employees detail view, there are two buttons that allow you to page through each employee in the Employees list view's current search

results. Clicking the Previous button displays the previous employee of the current search results while clicking the Next button displays the next employee of the current search results. The text in between shows which employee result you are currently viewing within the total number of current results.

» Chris Olliver

Edit ▾

◀ (2 of 125) ▶

Employee Status:	Active	Picture:	
Name:	Chris Olliver		

Editing Employees

Administrators may edit employees at any time to update or add information to the record. You can make changes to existing employee records via the Employees edit view and quick create forms. Edit view is available within the Employees module and includes all of the Employees fields you should need.

For instances that use SugarIdentity, the administrator can only edit employee records that are [created](#) directly in Sugar. For any employee records that are tied to a user record in SugarIdentity, there are certain [fields](#) (e.g. Office Phone, Title) in the employee's record that are read-only and can only be edited via the [Cloud Settings console](#).

[Joseph Kelly](#) » Edit

Save Cancel Save and Continue ◀

Employee Status:	Active ▾	Picture:	<input type="button" value="Choose File"/> No file chosen
First Name:	<input type="text" value="Joseph"/>	Last Name:	<input type="text" value="Kelly"/>
Title:	<input type="text" value="President"/>	Office Phone:	<input type="text" value="(408)555-9876"/>
Department:	<input type="text" value="N/A"/>	Mobile:	<input type="text" value="(408)555-1234"/>

Quick create is available for editing employees from the [Employees list view](#) and opens as a pop-up without navigating away from your current page. It generally contains fewer fields, but the Full Form button may be used to access the full edit view should you need to edit additional fields.

Joseph Kelly

Employee Status:	Active	Title:	President
First Name:	Joseph	Last Name: *	Kelly
Department:	N/A	Work Phone:	(408)555-9876
Reports to:		Email Address:	+
			joseph@sugar.com

Save Cancel Full Form

Sarah Smith Sales Manager West Jim Brennan sarah@example.com Activ

You may configure both the Employees edit view and quick create via Admin > Studio. For more information on configuring layouts, please refer to the [Studio](#) documentation in the Administration guide.

Editing Via Detail View

You can edit employees via the [detail view](#) by clicking the Edit button on the upper left of the page. Once the edit view layout is open, update the necessary fields, then click "Save" to preserve your changes.

» Joseph Kelly



Employee Status:	Active
Name:	Joseph Kelly

Editing Via List View

You can edit employees via the [list view](#) by clicking the Pencil icon to the left of each employee's name. A pop-up window will open with the quick create form which is a shortened version of the edit view layout. Update the necessary fields, then click "Save" to preserve your changes.

	Team Name	Description
	Global	Globally Visible

Deleting Employees

If an employee record is invalid or should no longer appear in your organization's Sugar instance, it may be deleted from the Employee's detail view. Deleting employee records will also delete the User record that this employee was related to.

Note: For instances that use SugarIdentity, the Delete option will not be available and administrators will need to access [SugarIdentity](#) via the Cloud Settings console in order to delete the user record. Deleting the user record via the Cloud Settings console will delete the corresponding user and employee records from Sugar.

Use the following steps to delete an employee record via the detail view:

1. Navigate to an employee record's detail view.
2. Click the Actions menu and select "Delete".

» Will Westin

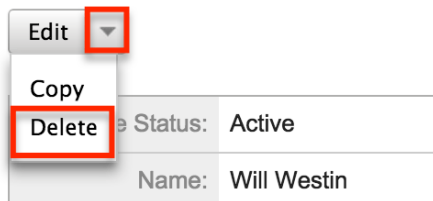

3. A pop-up message will display asking for confirmation and alerting you that the User record will also be deleted. Click "Ok" to proceed.

Exporting Employees

Sugar's Export option allows administrators to download all fields for the selected employees to their computers as a CSV (comma-separated values) file. This may be useful when needing to use Employee data with other software such as Microsoft Excel. Due to PHP memory limitations on the server, there may be occasions when the application times out while exporting a large number of employee records. If you encounter an error when performing this action, we recommend selecting the records in smaller batches.

Employees may be exported from the Employees list view by selecting "Export" from the Actions menu. For more information on exporting records in Sugar, please refer to the [Export](#) documentation.

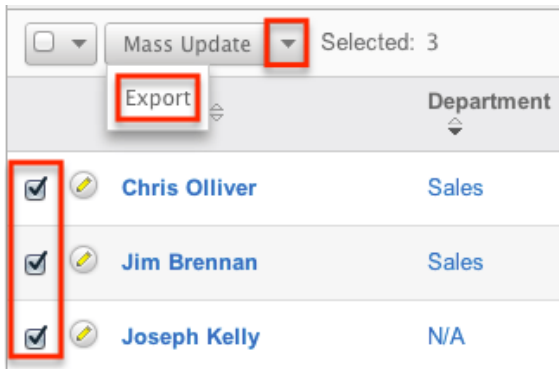

Mass Updating Employees

Mass Updating allows administrators to make the same change to multiple employee records at once from the Employees list view. Administrators can control which fields are available to change during mass update via Admin > Studio. Currently, only fields with the data type of date, datetime, dropdown, multiselect, and radio may be altered during a mass update. For more information on configuring mass update, please refer to the [Studio](#) documentation in the Administration guide. Due to the PHP memory limitations on the server, there may be occasions when the application times out while mass updating a large number of employee records. If you encounter an error when performing this action, we recommend selecting the records in smaller batches.

Use the following steps to mass update employee records from the list view:

1. Navigate to the Employees list view by clicking the Employees module tab.
2. Use the list view's [Basic](#) or [Advanced Search](#) to find employees you wish to modify.
3. Select the desired employees individually or using the [checkbox dropdown's](#) options.
4. Choose "Mass Update" from the Actions menu.



5. Scroll to the Mass Update panel and set values for the fields you wish to alter.

Mass Update

Display Employee Record	-none-	Employee Status:	-none-
Reports to	<input type="text"/>	Preferred Language:	-none-
		<input type="button" value="Select"/>	
<input type="button" value="Update"/>		<input type="button" value="Cancel"/>	

- Click "Update" to save the changes to all of the currently selected employee records.

Last Modified: 2019-12-05 15:47:53

Knowledge Base Administration

Overview

Sugar's Knowledge Base module provides the ability to create, maintain, and publish articles. Certain aspects of the Knowledge Base module are only available for administrators or users with developer-level role access including the creation and editing of templates and accessing the Knowledge Base settings. This documentation will cover information and actions specific to Knowledge Base administration.

For more information on actions available to regular users such as creating and editing articles, please refer to the [Knowledge Base](#) documentation in the Application Guide. For instructions concerning views and actions which are common across most Sugar modules, such as creating, editing, and deleting templates, please refer to the [Working With Sugar Modules](#) section of this page.

Working With Sugar Modules

While the Knowledge Base Templates list view has some features that only apply to KB templates, it also uses the Sidecar user interface that most Sugar modules are based on. In the table below, the left column contains links to the User Interface page covering topics that are applicable to all Sidecar modules. The right column has links to sections of the current page that cover topics specific to KB templates.

General Instructions for Working With Sugar Modules	KB-Templates-Specific Instructions

Use the links below to navigate to the User Interface page which covers topics generic to many Sugar modules.	When KB-Templates-specific help exists for each topic, use the links below to navigate to sections of the current page.
Creating Records	
Viewing Records	
Searching for Records	
List View	List View Mass Actions Menu List View Record Actions Menu
Record View	Record View Actions Menu
Intelligence Pane	
Editing Records	Settings
Deleting Records	
Exporting Records	
Merging Records	
Viewing Record Audit Logs	
Favoriting Records	
Following Records	
Sharing Records	
Using the TinyMCE Text Editor	

KB Template Menus

The Knowledge Base Templates section contains various options and functionality which are available via menus in the list view and record view. The following sections present each menu and its options with links to more information about each option in the User Interface documentation or, for Knowledge Base Templates-specific functionality, within this page.

List View Menus

The Knowledge Base Templates [list view](#) displays all knowledge base template records and allows for searching and filtering to locate specific templates. You can view the basic details of each record within the field columns of the list view or click an template's name to open the record view. To access a module's list view, simply click the Knowledge Base module's tab in the navigation bar at the top of any Sugar page and select "View Templates".

List View Mass Actions Menu

The Mass Actions menu to the right of the checkbox option in the list header allows you to perform mass actions on all currently selected records. You can use the checkbox on each record's row to select individual template records or click the checkbox in the list header to select all records displayed on the current set of list view results.

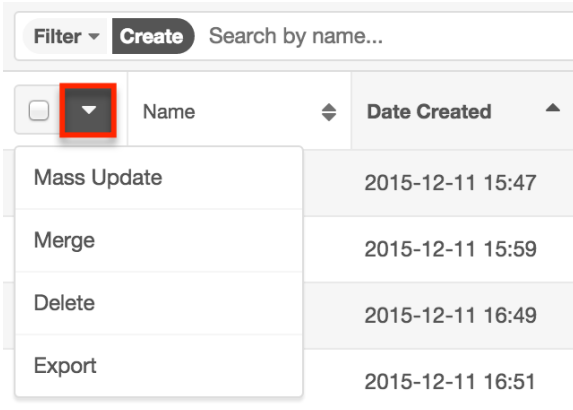

The Mass Actions menu allows you to perform the following operations:

Menu Item	Description
Mass Update	Mass update one or more templates at a time
Merge	Merge two or more duplicate templates
Delete	Delete one or more templates at a time
Export	Export one or more templates to a CSV file

List View Record Actions Menu

The Record Actions menu to the far right of each record's row allows you to perform actions on the individual template directly from the list view.

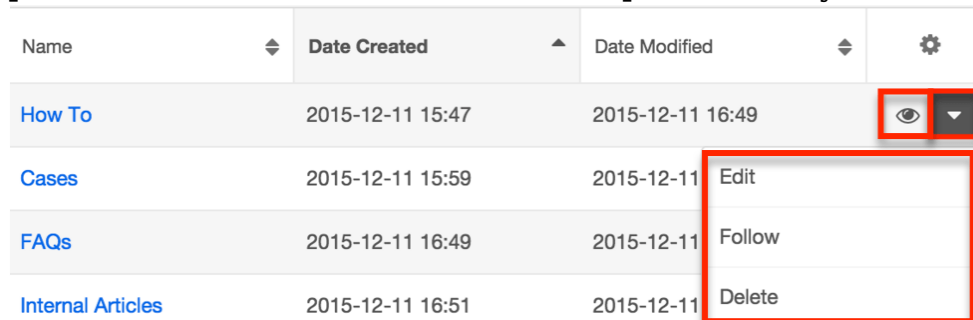

The list view's Record Actions menu allows you to perform the following operations:

Menu Item	Description
Preview (Eye icon)	Preview this template in the intelligence pane
Edit	Edit this template
Follow	Follow this template
Delete	Delete this template

Record View Actions Menu

The knowledge base template [record view](#) displays a single template in full detail including its fields and the activity stream. To access a template's record view, simply click a hyperlinked template name from anywhere within Sugar. The record view's Actions menu appears on the top right of the page and allows you to perform various operations on the current record.

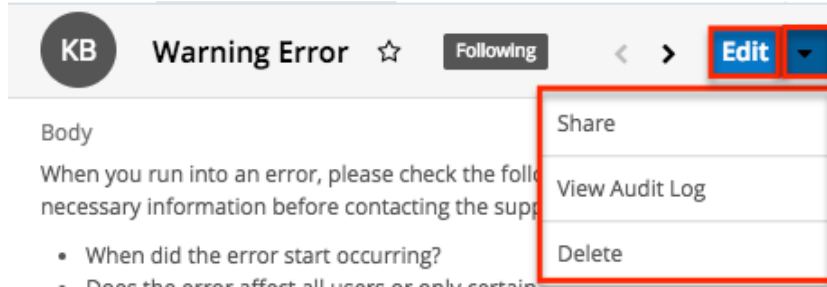

The Actions menu allows you to perform the following operations:

Menu Item	Description
Edit	Edit this template
Share	Share this template
View Audit Log	View a record of changes to this template
Delete	Delete this template

Settings

You have the option to add, edit, or delete different languages for article records in the Settings section. This is helpful if articles are to be translated into multiple languages. When one or more additional languages have been added, users can [create localization articles](#). It is important to note that when a language is deleted from the available languages, all localization articles created with that language will also be deleted.

To access the Settings page, click the triangle in the Knowledge Base module tab to open the Actions menu and select "Settings".

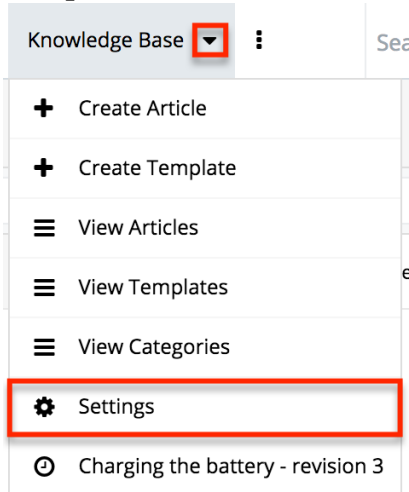

The Knowledge Base Settings drawer will appear which allows you to edit, add, or remove languages for the Knowledge Base module. To add a new language, click the "+" icon and enter the Language Code and Language Label. To remove a language, select the "-" icon. Click "Save" to finalize any changes made.

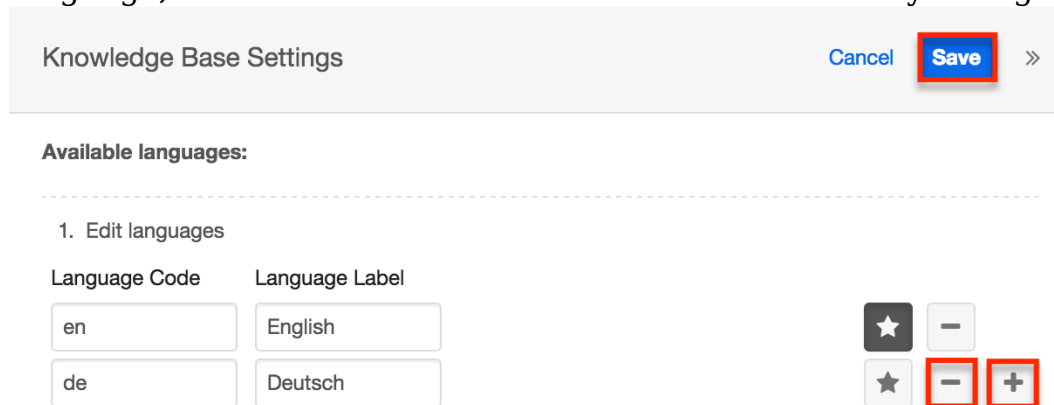

You can also set a language as primary by selecting the star to its far right. The primary language is set in the Language field by default for all new articles.

Available languages:

1. Edit languages

Language Code	Language Label
en	English
de	Deutsch

Set Value as Primary



Last Modified: 2019-12-05 15:47:53

Tag Management

Overview

Tags are user-created keywords or phrases that can help users find, group, and classify large amounts of data by common attributes that may not be defined via basic database fields. Sugar stores tags as individual records in the Tags module. Modules using the Sidecar user interface (e.g. Accounts, Contacts, etc.) contain a Tags field where users can create and share tags that can be used to identify records in filters, dashlets, and reports. For a list of sidecar modules, please refer to the [User Interface](#) documentation in the Application Guide.

While tags can be created and used by regular Sugar users, some actions in the Tags module are only available to administrators and users with developer-level role access. This documentation will cover these administration options which allow you to manage the system-wide tag repository. For information about tag functionality which is available to regular users, please refer to the [Tags](#) documentation in the Application Guide. For instructions concerning views and actions which are common across most Sugar modules, such as creating, editing, and deleting tags, please refer to the [Working With Tags](#) section of this page.

Note: The Tags module is not configurable in Studio.

Understanding Tag Behavior

The act of relating a tag to a Sugar record is referred to as "tagging". By default,

modules using the Sidecar user interface (e.g. Contacts, Leads, Accounts, etc.) are enabled for tagging and include the Tags field in the layout. Tags can be related to multiple records across any sidecar module, so a single tag can appear on multiple records. Likewise, a single record can have multiple tags. Unlike other Sugar modules, users can see all tag records regardless of their team memberships. Additionally, users will be able to edit Tag fields to add existing tags or create new tags regardless of any role restrictions their user has for the Tags module.

Please note that only administrators and users with developer-level role access may create, edit, merge, and delete tags in the Tags module. To assign a Tags Administrator role to a Sugar user, please refer to the [Creating a Tags Administrator](#) section of this page.

Note: While the "Find Duplicates" functionality is disabled for all users of the Tags module, users with administrator access to the Tags module can find and merge duplicate tag records via list view. For more information on merging records, refer to the [User Interface](#) documentation.

For more information on tag usage guidelines and interacting with tags in Sugar, please refer to the [Tags](#) documentation in the Application Guide.

Tag Fields

The Tags module contains a number of stock fields that come out-of-the-box with Sugar. For information on using and editing various field types, refer to the [User Interface](#) documentation. The definitions below are suggested meanings for the fields, but the fields can be leveraged differently to best meet your organization's needs.

Field	Description
Name	The name or designation of the tag
Assigned To	The Sugar user assigned to the tag record
Date Created	The date the tag record was created
Date Modified	The date the tag record was last modified
Description	A description or other information about the tag

Working With Tags

The following links will open specific sections of the User Interface documentation where you can read about views and actions that are common across most Sidecar modules. The sections following this Working With Tags section describe Tags-specific behaviors and functionality.

Content Link	Description
Creating Tags Basic Tag Creation Importing Tags	The Creating Records section covers the various methods of creating new tag records, including via the Create button in the Tags module and importing a list of tags into Sugar using a .csv spreadsheet.
Viewing Tags Viewing via List View Viewing via Record View Viewing via Recently Viewed Viewing via Dashlets Viewing via Preview Viewing via Reports	The Viewing Records section describes the various methods of viewing tag records, including via the Tags list view and record view, the Recently Viewed menu in the Tags module tab, list view dashlets showing tag information, previewing tags in the right hand side panel, and reports displaying tag data.
Searching for Tags List View Search Creating a Filter Saving a Filter	The Searching for Records section provides an introduction to list view search, which searches and filters within the Tags module. Note: For information on using tags as global search filters, please refer to the Tags documentation in the Application Guide.
Tags List View Total Record Count Create Button List View Search Checkbox Selection Mass Actions Menu Favorite Designation Column Reordering Column Resizing Column Sorting Column Selection Preview Record Actions Menu More Tags Dashboards	The List View section walks through the many elements of the Tags List View layout which contains a filterable list of all tag records in Sugar. While the generic menu options are described in the User Interface sections linked to the left, the options specifically available in the Tags list view are described in the List View Mass Actions Menu and List View Record Actions Menu sections of this page.
Tags Record View	The Record View section walks through

Favorite Designation Next or Previous Record Actions Menu Subpanels Related Record Subpanels Filtering Subpanels Reordering Subpanels Dashboards	<p>the many elements of the Tags Record View layout which contains detailed information about a single tag record. While the generic menu options are described in the User Interface sections linked to the left, the options specifically available in the Tags record view are described in the Record View Actions Menu section of this page.</p>
Editing Tags Editing Inline via Record View Editing via Record View Editing Inline via List View Mass Editing via List View	<p>The Editing Records section describes the various methods of editing existing tag records, including inline via the Tags record view, in full edit mode on the record view, inline via the Tags list view, and via the Mass Update option on the list view.</p> <p>Note: If the tag's name is edited, all records related to the tag will automatically display the updated tag value.</p>
Deleting Tags Deleting via Record View Deleting via List View Mass Deleting via List View	<p>The Deleting Records section describes the various methods of deleting unwanted tags, including via the Tags record view, an individual record's Actions menu on the Tags list view, and the Mass Actions menu on the list view.</p>
Exporting Tags	<p>The Exporting Records section provides an introduction to the export functionality which allows you to download a list of tags and all their data as a .csv file for use outside of Sugar (e.g. in Microsoft Excel).</p>
Merging Tags Merging via List View	<p>The Merging Records section provides instructions for merging duplicate tags which will combine field values and related records into a single tag.</p> <p>Note: Date Created and Date Modified field types are not supported when merging duplicate Tag records in Sugar.</p>
Viewing Tag Audit Logs	<p>The Viewing Record Audit Logs section describes the View Audit Log record view option which displays a history of changes to the tag's audited fields.</p> <p>Note: Only the Assigned User Id field is</p>

	audited for the Tags module and will be displayed in the audit log.
Favoriting Tags Favoriting via List View Favoriting via Record View	The Favoriting Records section describes the various methods of marking tags as favorites, including via the Tags list view or Tags record view. Favoriting a tag allows you to easily access it from list views, dashlets, or the Tags module tab.
Sharing Tags	The Sharing Records section provides instructions for the Share record view option which composes an email with a link to the tag record. If the recipient is logged into Sugar, clicking the link will bring them directly to the tag's record view.

Tag Menus

The Tags module contains various options and functionality which are available via menus in the module tab, list view, and record view. The following sections present each menu and its options with links to more information about each option in the User Interface documentation or, for Tags-specific functionality, within this page.

Module Tab Menus

The Tags module tab is typically found by clicking the arrow to the right of the navigation bar tabs at the top of any Sugar screen. The additional modules will appear on the list and you can click "Tags" to access the list view. Once the Tags module tab displays on the navigation bar, you can click the triangle within the tab to display the Actions, Recently Viewed, and Favorites menu. The Actions menu allows you to perform important actions within the module. The [Recently Viewed menu](#) displays the list of tags you most recently viewed. The [Favorites menu](#) displays the list of tags you most recently marked as favorites.

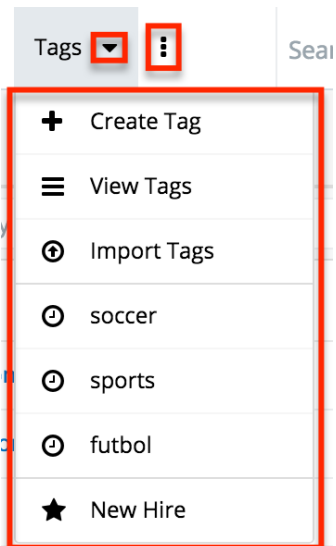

The module tab's Actions menu allows you to perform the following operations:

Menu Item	Description
Create Tag	Opens the record view layout to create a new tag
View Tags	Opens the list view layout to search and display tags
Import Tags	Opens the import wizard to create or update tags using external data

If you do not see the Tags module tab in Sugar, please check the following:

- The Tags module may be marked as hidden in your user preferences which will prevent the module tab from being displayed. Navigate to your user profile (upper right of Sugar), click the Advanced tab, and check the Layout Options section. If you see the Tags module in the Hide Modules list, simply move it to the Display Modules list and save. For more information on hiding and displaying modules, please refer to the [Layout Options](#) section of the Getting Started documentation in the Application Guide.
- The Tags module may be disabled for your entire Sugar instance. Enable the Tags module and add the Tags field to related module layouts. For more information on displaying and hiding modules throughout Sugar, please refer to the [Developer Tools](#) documentation.

List View Menus

The Tags [list view](#) displays all tag records and allows for searching and filtering to locate specific tags. You can view the basic details of each record within the field

columns of the list view or click a tag's name to open the record view. To access a module's list view, simply click the module's tab in the navigation bar at the top of any Sugar page.

List View Mass Actions Menu

The Mass Actions menu to the right of the checkbox option in the list header allows you to perform mass actions on all currently selected records. You can use the checkbox on each record's row to select individual tag records or click the checkbox in the list header to select all records displayed on the current set of list view results.

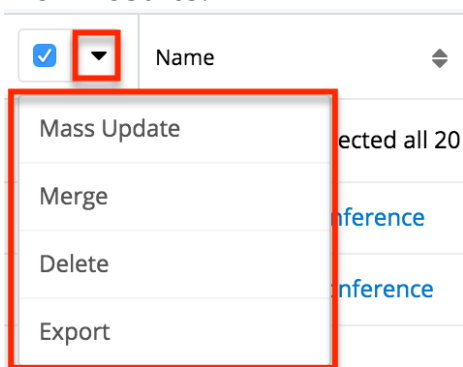

The Mass Actions menu allows you to perform the following operations:

Menu Item	Description
Mass Update	Mass update one or more tags at a time
Merge	Merge two or more duplicate tags
Delete	Delete one or more tags at a time
Export	Export one or more tags to a CSV file

Note: While the "Find Duplicates" functionality is disabled for all users of the Tags module, users with administrator access to the Tags module can find and merge duplicate tag records via list view. For more information on merging records, refer to the [User Interface](#) documentation.

List View Record Actions Menu

The Record Actions menu to the far right of each record's row allows you to perform actions on the individual tag directly from the list view.

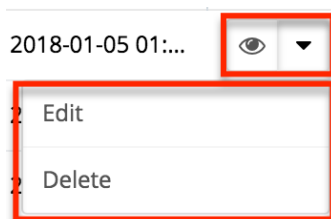

The options in the Record Actions menu allow you to perform the following operations:

Menu Item	Description
Preview	Preview this tag in the intelligence pane
Edit	Edit this tag
Delete	Delete this tag

Record View Actions Menu

The Tags [record view](#) displays a single tag in full detail including its relevant fields and subpanels of related records. To access a tag's record view, simply click a hyperlinked tag name from the Tags list view, Tags list view dashlet, or from report results. The record view's Actions menu appears on the top right of the page and allows you to perform various operations on the current record.

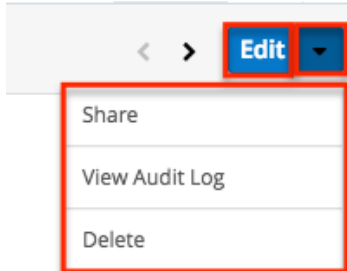

The Actions menu allows you to perform the following operations:

Menu Item	Description
Edit	Edit this tag
Share	Share a link to this tag via email
View Audit Log	View a record of changes to this tag
Delete	Delete this tag

Consolidating Synonymous Tags

Sugar prohibits users from saving duplicate tag records, but with many users working in and importing new records to Sugar, it is possible for synonymous tag records (e.g. computer and computers) to accidentally occur in the system.

Before creating a new tag record, a good practice is to first check that a similar tag does not already exist in Sugar. You can locate candidates for cleanup using the list view search from the Tags list view. Searching for tags with similar names or other information can turn search into a powerful, duplicate-finding tool. If synonymous tag records are detected, perform a merge as described in the [User Interface](#) documentation.

Note: While the "Find Duplicates" functionality is disabled for all users of the Tags module, users with administrator access to the Tags module can find and merge duplicate tag records via list view.

Creating a Tags Administrator

By default, only administrator or developer users have the ability to create, edit, delete, and merge tags in the Tags module. It may be helpful to delegate these administrative tasks to one or more designated user(s) without giving them full administrative permissions in Sugar.

Use the following steps to create a Tags Administrator role:

1. Navigate to Admin > Role Management.
2. Click the triangle in the Roles module tab and select "Create Role".

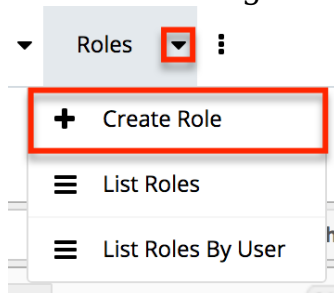

3. Enter a name (e.g. Tags Administrator) for the role then click "Save".
4. On the Role Chart screen, click "Tags" in the module's list to the far left of the page.

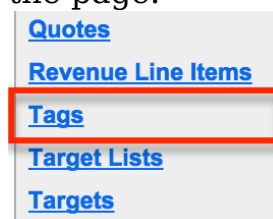

5. The following screen will display the role settings specific to the Tags module. The Access and Access Type columns will default to "Not Set". Click the "Not Set" in both columns and select the following options::

- **Access** : Enabled

Note: Access Type settings can remain as "Not Set" since the Admin access type will ensure full access to the remaining options.

Double click on a cell to change value.

Tags

Save Cancel

Access	Access Type	Delete	Edit	Export
Enabled	Admin	Not Set	Not Set	Not Set

Field Permissions

Assigned to	Not Set	Created By	Not Set
Modified By	Not Set	Favorite	Not Set
External source ID	Not Set	External source meta	Not Set

6. Click "Save" to preserve the changes.
7. Scroll to the Users subpanel on the bottom of the screen and click "Select User". Search and select the user(s) you wish to assign this role to.

Users

Select User

(0 - 0 of 0)

Name	User Name	Email	Phone
No data			

8. After selecting the user(s), navigate to the user's profile to view their access information via the Access tab. Confirm that the Tags Administrator role is displayed in the Roles subpanel and the Tag module's access is set to "Admin".

Revenue Line Items	Enabled	Normal	All	All	All	All	All	All	All
Tags	Enabled	Admin	All	All	All	All	All	All	All
Target Lists	Enabled	Normal	All	All	All	All	All	All	All
Targets	Enabled	Normal	All	All	All	All	All	All	All
Tasks	Enabled	Normal	All	All	All	All	All	All	All
Tracker Performance	None	None	None	None	None	None	None	All	None
Tracker Queries	None	None	None	None	None	None	None	All	None
Tracker Sessions	None	None	None	None	None	None	None	All	None
Trackers	None	None	None	None	None	None	None	All	None
Users/Teams/Roles	Enabled	Normal	All	All	All	All	All	All	All
Web Logic Hooks	Enabled	Normal	All	All	All	All	All	All	All

Roles

Select (1 - 2 of 2)

Name	Description	edit
Sales Administrator	Sales Administrator Role	edit
Tags Administrator		edit

Any user assigned to the Tags Administrator role will have the ability to access increased functionality such as creating, editing, deleting, and merging records in the Tags module. For more information on creating roles, please refer to the [Role Management](#) documentation.

Last Modified: 2019-12-05 15:47:53

Console Management

Overview

The [Service Console](#) and [Renewals Console](#) are Home page dashboards that provide a powerful work environment for customer service agents as well as Sales agents and Customer Success Managers. The consoles can be managed and configured by system admin users with a Serve [license type](#) (for Service Console) or Sell license type (for Renewals Console). In addition, a regular Serve or Sell user who is [assigned](#) to the dashboard has the ability to administer and configure the consoles. For more information on how to configure the various parts of the consoles, refer to the [Configuring the Consoles](#) section below. Please note that the Service Console and Renewals Console dashboards cannot be duplicated or deleted.

Prerequisites

In order to configure the consoles, the following requirements must be met:

- You must be a system administrator user.
Note: The system admin can also assign the console dashboard to a regular Serve or Sell user if they wish to designate a console administrator who will manage the dashboard for the organization. For more information, refer to the [section](#) below.
- You must have a Sugar Serve license type to configure the Service Console.
- You must have a Sugar Sell license type to configure the Renewals Console.

Designating a Console Administrator

If you wish to designate a non-admin user as a console administrator to manage and configure the consoles for your organization, you will need to assign the applicable dashboards to the specific user. Use the following steps to designate a user as a console administrator:

1. Navigate to the Home page, click the triangle next to the Home module tab (Sugar cube icon), and select "Manage Dashboards".

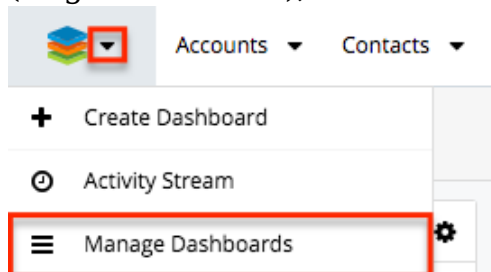

2. In the Dashboards module list view, select the console (i.e. Service Console, Renewals Console) that you wish to designate a console administrator for.

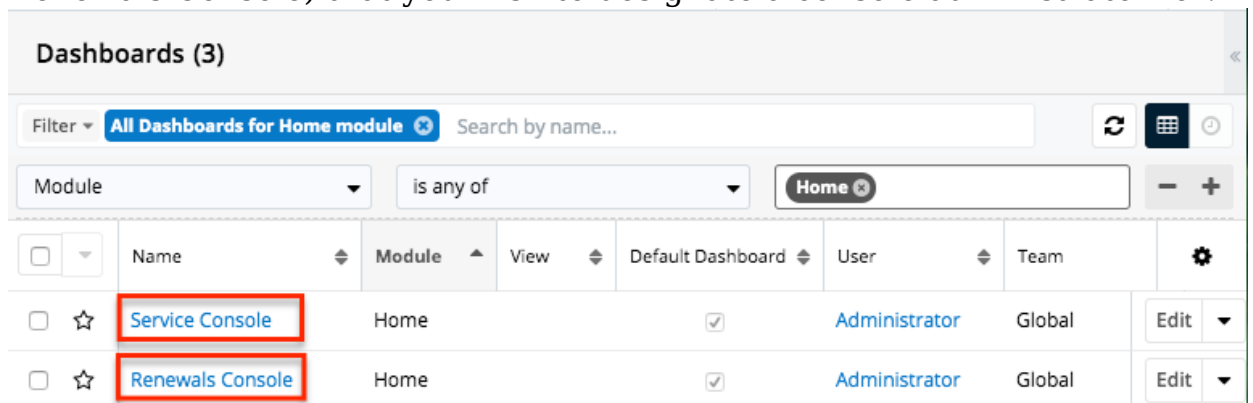
A screenshot of the 'Dashboards (3)' list view. The table shows three dashboards: 'Service Console' and 'Renewals Console' are highlighted with red boxes. The 'Service Console' row is selected. The table columns include Name, Module, View, Default Dashboard, User, and Team. The 'Service Console' is assigned to the 'Administrator' user.

<input type="checkbox"/>	Name	Module	View	Default Dashboard	User	Team	
<input type="checkbox"/>	Service Console	Home		<input checked="" type="checkbox"/>	Administrator	Global	Edit
<input type="checkbox"/>	Renewals Console	Home		<input checked="" type="checkbox"/>	Administrator	Global	Edit

3. Change the Assigned To field to the desired user.

- Next, navigate back to "Manage Dashboards" and remove the filter in the Dashboards list view to display all available dashboards. If you are designating a console administrator for the Service Console, locate the Case Details dashboard and reassign it to the same user from Step 3. For the Renewals Console, locate and reassign the "Account Details" and "Opportunity Details" dashboards to the same user from Step 3. Please note that you must reassign this dashboard to the user in order to give them the ability to [edit](#) the dashlets contained in the Case Detail drawer (for Service Console), Account Detail drawer (for Renewals Console), and Opportunity Detail drawer (for Renewals Console).

Dashboards (20)									
Filter Create Search by name...									
<input type="checkbox"/>	Name	Module	View	Default Dashboard	User	Team			
<input type="checkbox"/>	Service Console	Home		<input checked="" type="checkbox"/>	Max Jensen	Global	Edit		
<input type="checkbox"/>	Renewals Console	Home		<input checked="" type="checkbox"/>	Administrator	Global	Edit		
<input type="checkbox"/>	Home Dashboard	Home		<input checked="" type="checkbox"/>	Administrator	Global	Edit		
<input type="checkbox"/>	Opportunity Details	Opportuni...	Multi-line List	<input checked="" type="checkbox"/>	Administrator	Global	Edit		
<input type="checkbox"/>	Case Details	Cases	Multi-line List	<input checked="" type="checkbox"/>	Administrator	Global	Edit		
<input type="checkbox"/>	Account Details	Accounts	Multi-line List	<input checked="" type="checkbox"/>	Administrator	Global	Edit		

Once the applicable dashboards have been reassigned to the desired user, going forward the user assigned to the dashboards will be able to manage and configure the consoles just like the system admin user.

Configuring the Consoles

The Console can be configured by system admin users or by a regular user who is [assigned](#) to the dashboard. Please note that the user must have a Sugar Serve license type to access and configure the Serve Console, and a Sugar Sell license type to access and configure the Renewals Console. Also, keep in mind that in order to access and configure the dashlets in the module tab drawers (e.g. Case

Detail drawer), you will need to have at least one record assigned to you. Any changes made to the Consoles will update the dashboard for all users who access the console. The following sections cover the basics of configuring the Overview tab, the module tab lists, and the module tab drawers.

Configuring the Overview Tab

Admin users and the user assigned to the Console dashboard can configure the Overview tab on the console to [rename](#) the dashboard, add and remove dashlet rows and dashlets, rearrange dashlets, edit dashlets, as well as reconfigure the [column layout](#) on the dashboard. To configure, simply select the "Edit Overview Tab" option from the Console dashboard's Actions menu. The Overview will open in standard dashboard-edit mode where you can customize the dashboard to suit your business needs. Please note that the changes made to the Overview tab will be updated for all users who access the console.

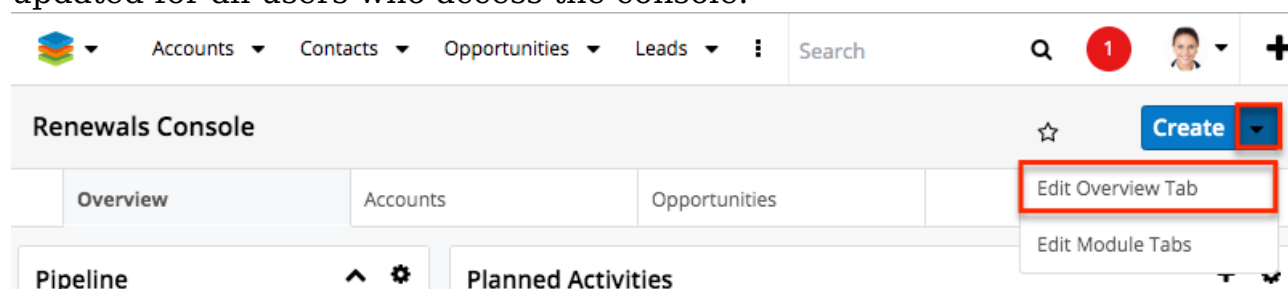

To add dashlet rows and dashlets, click the "+ 1 column" in the Add a Row box then click the Add a Sugar Dashlet box that appears to select and configure your desired dashlet. You can delete dashlet rows and dashlets by clicking the Gear icon at the top right of the dashlet or the dashlet row's Gear icon and selecting "Remove".

To change the position of dashlets in the Overview tab, simply drag and drop the dashlet in the desired location to swap the position of two dashlets in the dashboard. In addition, you can rearrange the dashboard rows by using the Up and Down arrow icon on the upper right of each dashboard row.

You can also configure dashlets in the dashboard by clicking the Gear icon at the top right of the dashlet and selecting "Edit" which will display configuration options specific to the dashlet.

For more information on adding or deleting dashlet rows and dashlets as well as rearranging and editing dashlets, refer to the [Dashboards and Dashlets](#) documentation.

Configuring the Module Tab Lists

The Console's module tab contains a prioritized list view of the current user's open cases (for Service Console) as well as their assigned accounts and opportunities (for Renewals Console). The system admin or the user assigned to the dashboard have the option to configure the module tab lists and set a default sort order and/or apply a filter to the list view. To configure the settings, simply select the "Edit Module Tabs" option from the Console dashboard's Actions menu and the Console Settings window will open.

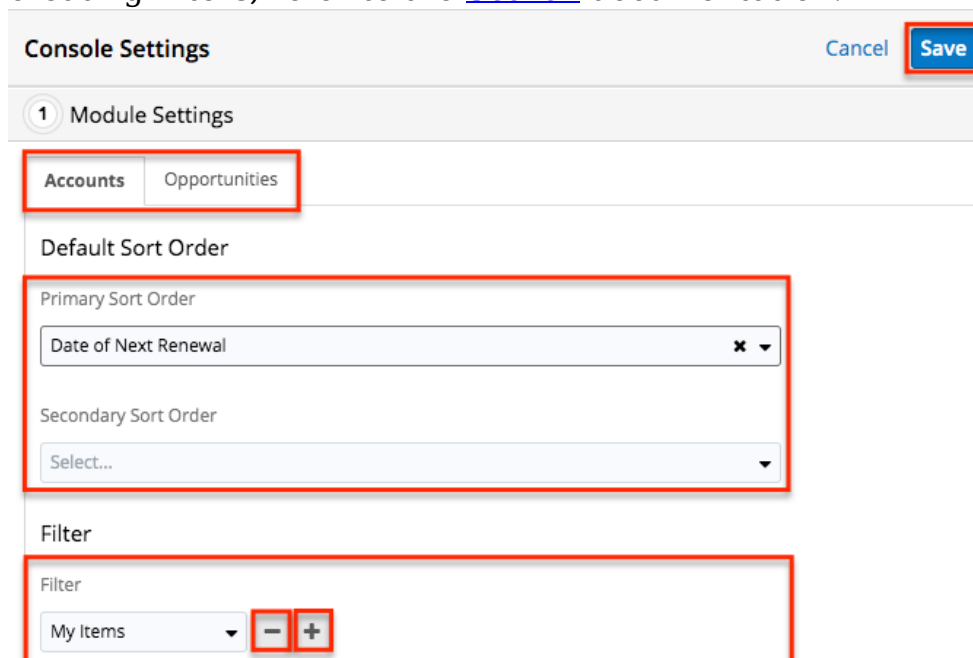

Please note that the Console Settings window may display multiple tabs (e.g. Accounts, Opportunities) to allow you to set the default sort order and define a filter for each module tab list that is available within the console. To set a default sort order, simply select a primary and optional secondary-level sort order for the list's display in the Default Sort Order section. The Filter section below allows you to filter the list view based on pre-defined filters (e.g. My Items) as well as create custom filters. Simply use the plus and minus buttons to add or remove filter criteria like you would for a standard list view filter. For more information on creating filters, refer to the [Search](#) documentation.

A screenshot of the 'Console Settings' window. At the top right, there are 'Cancel' and 'Save' buttons. The window is titled '1 Module Settings'. Below the title, there are two tabs: 'Accounts' and 'Opportunities'. The 'Accounts' tab is selected and highlighted with a red box. Underneath, there are three sections: 'Default Sort Order', 'Filter', and 'Filter'. The 'Default Sort Order' section has a 'Primary Sort Order' dropdown set to 'Date of Next Renewal' and a 'Secondary Sort Order' dropdown set to 'Select...'. The 'Filter' section has a dropdown set to 'My Items' and two buttons: a minus sign (-) and a plus sign (+). The 'Filter' section is also highlighted with a red box.

Once you have made the necessary configurations, click "Save" to preserve the change and update the module tab's view for all users who access the console.

Configuring the Module Tab Drawers

The module tab drawers can be accessed by clicking on a module tab (e.g. Cases) in the console (e.g. Service Console) then clicking the desired record's row in the list view. This opens a drawer within the console which aggregates key information about the record, its related records, past/upcoming interactions (e.g. emails, calls, meetings), etc. The drawer contains four dashlets which can be rearranged and configured by system admin users as well as the regular user [assigned](#) to the dashboard. In order to access and configure the dashlets in the module tab drawers (e.g. Case Detail drawer), you will need to have at least one record assigned to you. Please note that dashlets cannot be removed from or added to the module tab drawers.

The screenshot shows the Service Console interface. On the left, there is a list of cases with columns for Number, Priority/Status, and Follow Up. Two cases are visible: case 243 with a 'Pending Input' status and case 245 with an 'Assigned' status. The 'Cases' tab is highlighted. On the right, a detailed view for case 243 is shown for 'Jungle Systems Inc'. This view includes fields for Website, Member of, Business Center Name, Industry, Retention, Type, and Service Level. A red box highlights the 'Edit' button and a gear icon in the top right corner of the case detail drawer.

To change the position of dashlets in the module tab drawer, simply drag and drop the dashlet in the desired location on the layout to swap the position of two dashlets. You can also configure the dashlets in the dashboard by clicking the Gear icon at the top right of the dashlet and selecting "Edit" which will display configuration options specific to the dashlet. Any changes made to the layout and dashlet settings will be updated for all users who access the console. For more information on rearranging and editing dashlets, refer to the [Dashboards and Dashlets](#) documentation.

Note: Record view dashlets such as the [Case Record Dashlet](#), [Account Record Dashlet](#), [Opportunity Record Dashlet](#), etc. can be edited via Studio > {Module Name} > Layouts > Record View Dashlet. For more information, refer to the [Dashboards and Dashlets](#) and [Studio](#) documentation.

Last Modified: 2020-01-10 21:16:35